

# Spare Parts for European Trucks & Trailers

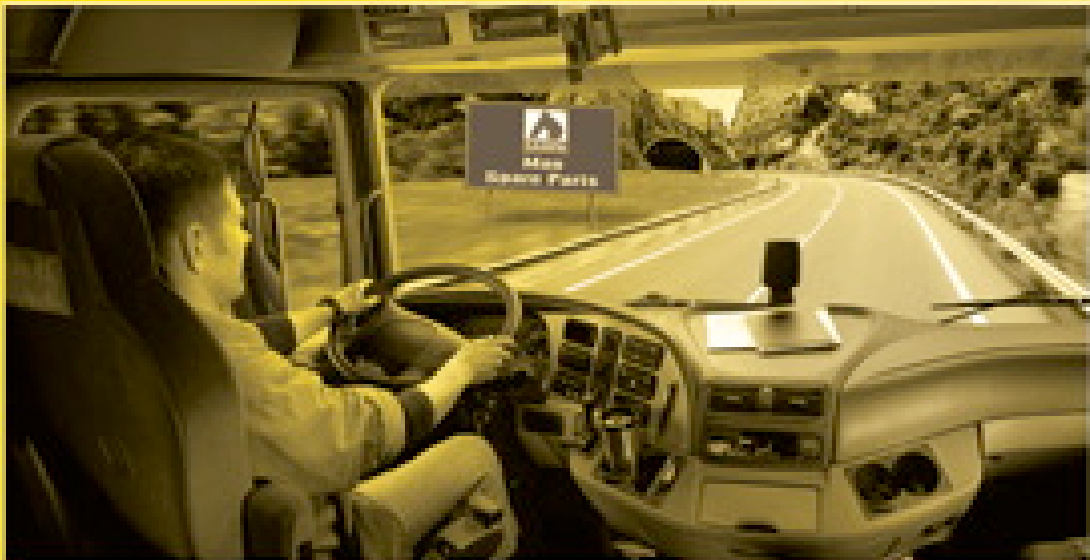

# 2

## MAN

"technology, reliability & quality..."



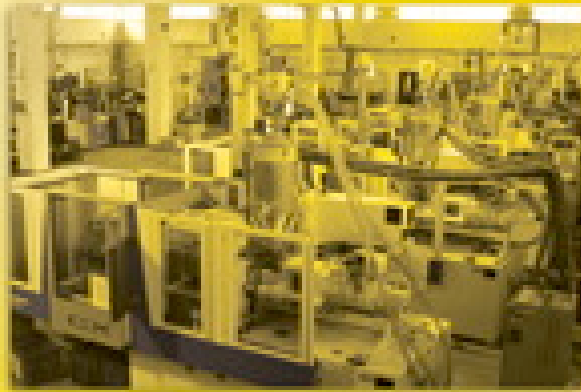

[www.sampalkw.com](http://www.sampalkw.com)





"technology, reliability & quality..."

[www.sampalkw.com](http://www.sampalkw.com)

<b>Sampa Nr.</b>	
<b>020.025</b>	
<b>O.E.M. Nr.</b>	
<b>81.43722.0062</b> <b>(81.43722.0045)</b>	
<b>Dimension</b>	<b>ø24xø70x105</b>
<b>Description</b>	
Rubber Bushing for Spring	
F 2000 ÖAF	

<b>Sampa Nr.</b>	
<b>020.029</b>	
<b>O.E.M. Nr.</b>	
<b>81.43722.0061</b> <b>(81.43722.0044)</b>	
<b>Dimension</b>	<b>ø24xø70x95</b>
<b>Description</b>	
Rubber Bushing for Spring	
18.220/290/370 26T6 F 2000 ÖAF	

<b>Sampa Nr.</b>	
<b>020.038</b>	
<b>O.E.M. Nr.</b>	
<b>81.43722.0051</b> <b>(81.43722.0078)</b> <b>(81.43722.0079)</b>	
<b>Dimension</b>	<b>ø20xø57x84</b>
<b>Description</b>	
Rubber Bushing for Spring	
12.220 14.280 L 2000 M 2000	

<b>Sampa Nr.</b>	
<b>020.188</b>	
<b>O.E.M. Nr.</b>	
<b>81.43722.0070</b>	
<b>Dimension</b>	<b>ø24xø65x95</b>
<b>Description</b>	
Rubber Bushing for Spring	
ECT18/26 TGA	

<b>Sampa Nr.</b>	
<b>020.030</b>	
<b>O.E.M. Nr.</b>	
<b>81.96020.0250</b> <b>(81.96020.0231)</b> <b>(81.96020.0252)</b>	
<b>Dimension</b>	<b>ø16xø50x95</b>
<b>Description</b>	
Rubber Bushing for Spring	
10/11.150/180/190/220/230 12.220 13.210/220/230 6/8.90 F/FR 8/9.136 8/9.136 F/FR	
8/9.136/170 G 90 L 2000 M 2000 M 90	

<b>Sampa Nr.</b>	
<b>020.148</b>	
<b>O.E.M. Nr.</b>	
<b>81.96210.5022</b> <b>(81.96210.5021)</b> <b>(81.96210.5023)</b>	
<b>Dimension</b>	<b>h:127</b>
<b>Description</b>	
Spring Cushion	
F 2000 F 90 L 2000 ÖAF	

## Spring Suspension

MAN



Sampa Nr.

**020.167**

O.E.M. Nr.

**81.96210.5025**  
(81.96210.5026)  
(81.96210.5027)

Dimension

h:166

Description

Spring Cushion

ÖAF  
F 2000



Sampa Nr.

**020.208**

O.E.M. Nr.

**81.96210.0550**

Dimension

h:154

Description

Spring Cushion

TGA  
F 2000



Sampa Nr.

**020.185**

O.E.M. Nr.

**81.96210.0555**  
(81.96210.0548)

Dimension

h:133

Description

Spring Cushion

F 2000  
TGA



Sampa Nr.

**020.186**

O.E.M. Nr.

**81.96210.0554**  
(81.96210.0547)

Dimension

h:133

Description

Spring Cushion

F 2000  
TGA



Sampa Nr.

**020.210**

O.E.M. Nr.

**06.01494.4933**

Dimension

M20x2/260

Description

Spring Pin

F 2000  
TGA



Sampa Nr.

**020.211**

O.E.M. Nr.

**06.01494.4935**

Dimension

M20x2/240

Description

Spring Pin

F 2000  
TGA

<b>Sampa Nr.</b>	
<b>020.103</b>	
<b>O.E.M. Nr.</b>	
<b>81.96210.0402</b>	
<b>Dimension</b>	M12/41
<b>Description</b>	Spring Buffer
G 90 L 2000 M 2000	

<b>Sampa Nr.</b>	
<b>020.168</b>	
<b>O.E.M. Nr.</b>	
<b>81.96210.0431</b> <b>(81.96210.0532)</b>	
<b>Dimension</b>	M8/19
<b>Description</b>	Spring Buffer
L 2000 M 2000 M 90	

<b>Sampa Nr.</b>	
<b>020.081</b>	
<b>O.E.M. Nr.</b>	
<b>81.96101.0739</b> <b>(81.96101.0690)</b>	
<b>Dimension</b>	ø70x20
<b>Description</b>	Spring Buffer
G 90 L 2000 M 2000 M 90 M 2000 L M 2000 M	

<b>Sampa Nr.</b>	
<b>011.250</b>	
<b>O.E.M. Nr.</b>	
<b>81.43407.0109</b> <b>(81.43407.0509)</b>	
<b>Dimension</b>	84x110x18
<b>Description</b>	Spring Buffer
18.220/290/370 ECT18 ECT26 F 2000 F 90	L 2000 M 2000 ÖAF TGA

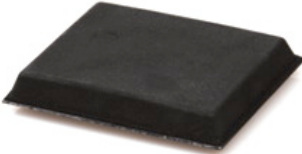
<b>Sampa Nr.</b>	
<b>020.083</b>	
<b>O.E.M. Nr.</b>	
<b>83.96020.0506</b> <b>(81.43400.6484)</b>	
<b>Dimension</b>	105x87.5x18.5
<b>Description</b>	Spring Buffer
F 90 F 2000 ÖAF	

<b>Sampa Nr.</b>	
<b>020.194</b>	
<b>O.E.M. Nr.</b>	
<b>81.43407.0102</b>	
<b>Dimension</b>	100x140x18
<b>Description</b>	Spring Buffer
F 2000 ÖAF	

# Spring Suspension

MAN

 <p><b>Sampa Nr.</b> <b>020.108</b></p> <p><b>O.E.M. Nr.</b> <b>81.96020.6006</b> <b>(81.96020.0172)</b> <b>(81.96020.0136)</b> <b>(81.96020.0110)</b></p> <p><b>Dimension</b> ø95.5x96</p> <p><b>Description</b> Spring Buffer</p> <p>14/15.220 - 15/19.240 16.200/220/240/280/290/360/372 16/19/26/27/30/32/33/34.281/291/321/331/361 17.220/240 - 18.220/290/370 - 19.240 22/24/25.220/240/281/291/321/331/361 26/32.365 - 26T F 2000 - F 90 - L 2000 - M 2000 - M 90 ÖAF - TGA</p>		 <p><b>Sampa Nr.</b> <b>020.190</b></p> <p><b>O.E.M. Nr.</b> <b>81.96020.0230</b> <b>(81.96020.0277)</b> <b>(81.96020.0280)</b></p> <p><b>Dimension</b> ø70x80</p> <p><b>Description</b> Spring Buffer</p> <p>6/8.90 8/9.136/170 G 90 L 2000 M 2000</p>	
 <p><b>Sampa Nr.</b> <b>020.111</b></p> <p><b>O.E.M. Nr.</b> <b>81.41306.0090</b> <b>(81.41306.0070)</b> <b>(81.41306.0087)</b></p> <p><b>Dimension</b> ø25x130</p> <p><b>Description</b> Spring Pin</p> <p>12.170/192 14.170/192 16.170/192 17.170/192 M 90</p>		 <p><b>Sampa Nr.</b> <b>020.112</b></p> <p><b>O.E.M. Nr.</b> <b>81.41306.0081</b> <b>(81.41306.0072)</b> <b>(81.41306.0058)</b></p> <p><b>Dimension</b> ø25x143</p> <p><b>Description</b> Spring Pin</p> <p>14/15.220 15.240 16.240/280/290 ÖAF</p>	
 <p><b>Sampa Nr.</b> <b>020.113</b></p> <p><b>O.E.M. Nr.</b> <b>81.41306.0084</b> <b>(81.41306.0071)</b> <b>(81.41306.0067)</b> <b>(81.41306.0080)</b> <b>(81.41306.0055)</b></p> <p><b>Dimension</b> ø25x143</p> <p><b>Description</b> Spring Pin</p> <p>14/15.220/15.240 16.200/240/280/290 19.240 26/32.240/281/301/321</p>		 <p><b>Sampa Nr.</b> <b>020.114</b></p> <p><b>O.E.M. Nr.</b> <b>81.41306.0095</b></p> <p><b>Dimension</b> ø30x142</p> <p><b>Description</b> Spring Pin</p> <p>19T F 2000 F 90 ÖAF</p>	

**Sampa Nr.**  
**020.115**

**O.E.M. Nr.**  
**81.41306.0088**



**Dimension**  
ø30x143

**Description**  
Spring Pin

16.220/240/281/291/321/331/361      26/27/30/32/33/34.281/291/321/331/361  
17.220/240      26/32.365  
19.240/281/291/321/331/361      F 90  
22/24/25/26.220/240/281/291/321/331/361      M 90

**Sampa Nr.**  
**020.116**

**O.E.M. Nr.**  
**81.41306.0089**



**Dimension**  
ø30x145

**Description**  
Spring Pin

**Sampa Nr.**  
**020.117**

**O.E.M. Nr.**  
**81.41306.0092**  
**(81.91001.0453)**



**Dimension**  
ø30x160

**Description**  
Spring Pin

30/32/33/34.281/291/321/331/361

**Sampa Nr.**  
**020.118**

**O.E.M. Nr.**  
**81.41306.0085**  
**(81.41306.0078)**  
**(81.41306.0074)**  
**(81.41306.0001)**



**Dimension**  
ø30x162

**Description**  
Spring Pin

**Sampa Nr.**  
**020.119**

**O.E.M. Nr.**  
**81.41306.0097**



**Dimension**  
ø30x164

**Description**  
Spring Pin

19T      F 90  
F 2000      ÖAF

**Description**  
Spring Pin

14.220  
15/22/24/25/26.220/240  
16.170/192/200/220/240/280/281/290/291/321/331/361  
17.170/192/220/240  
19.240/281/291/321/331/361  
22/24/25/26/27/30/32/33/34.281/291/321/331/361  
26/32.365  
8/9.136  
F 90  
M 90  
ÖAF

**Sampa Nr.**  
**020.121**

**O.E.M. Nr.**  
**81.91020.0327**  
**(81.91020.0255)**



**Dimension**  
ø40x161

**Description**  
Spring Pin

**Sampa Nr.**  
**020.120**

**O.E.M. Nr.**  
**81.41306.0096**



**Dimension**  
ø30x162

**Description**  
Spring Pin

16.200/240/280/290  
F 90

# Spring Suspension

MAN



Sampa Nr.

**020.122**

O.E.M. Nr.

**81.41304.0043**  
**(81.41304.0008)**  
**(81.43420.0014)**

Dimension

ø25xø30x77.5

Description

Spring Bushing

12.170/192                      17.170/192  
14.170/192                      M 90  
16.170/192                      ÖAF



Sampa Nr.

**020.123**

O.E.M. Nr.

**81.41304.0042**  
**(81.43420.0000)**

Dimension

ø25xø30x87.5

Description

Spring Bushing

14.220                              19.240  
15.220/240                      26/32.240/281/301/321  
16.200/240/280/290



Sampa Nr.

**020.124**

O.E.M. Nr.

**81.41304.0041**  
**(81.41304.0032)**

Dimension

ø30xø36x77.5

Description

Spring Bushing

12.170/192                      17.170/192  
14.170/192                      M 90  
16.170/192



Sampa Nr.

**020.125**

O.E.M. Nr.

**81.41304.0044**  
**(81.41304.0052)**

Dimension

ø30xø36x87.5

Description

Spring Bushing

16.200/220/240/280/281/290/291/321/331/361  
17.220/240 - 24.350/400  
18.220/290/310/313/350/370/400/420/460  
19.240/281/291/321/331/361  
22/24/25/26.220/240/281/291/321/331/361  
26.281/291/321/331/361/365  
27.281/291/321/331/361  
30.281/291/321/331/361  
32.281/291/321/331/361/365  
33.281/291/321/331/361  
34.281/291/321/331/361  
EL 202/222/262  
F 2000 - F 90 - M 2000 - M 90 - ND202  
NG 242/252/262/272/312 - NGT 204  
NL 202/205/213/222/232/250/252/262/312  
NM 152 - ÖAF  
UEL 242/272/292/312/322



Sampa Nr.

**020.126**

O.E.M. Nr.

**81.41304.0040**  
**(81.41304.0038)**  
**(81.43420.0012)**

Dimension

ø30xø36x97.3

Description

Spring Bushing

14/15.220/15.240  
16.220/240/280/281/290/291/321/331/361  
17.220/240  
18.220/290/370  
19.240/281/291/321/331/361  
22.220/240/281/291/321/331/361  
24.220/240/281/291/321/331/361  
25.220/240/281/291/321/331/361  
26.220/240/281/291/321/331/361  
26.281/291/321/331/361/365  
30.281/291/321/331/361  
32.281/291/321/331/361/365  
33.281/291/321/331/361  
34.281/291/321/331/361  
8/9.136  
19T - F 2000 - F 90 - G 90 - M 2000 - M 90 - ÖAF

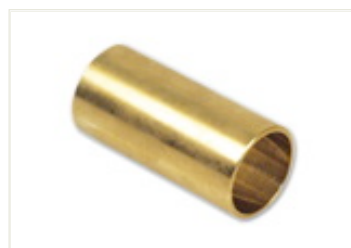

Sampa Nr.

**020.127**

O.E.M. Nr.

**81.41304.0037**  
**(81.41304.0031)**

Dimension

ø40xø46x97

Description

Spring Bushing

**Sampa Nr.**  
**020.130**

**O.E.M. Nr.**  
**81.41304.0020**



**Dimension**  
ø42xø48x95

**Description**  
Spring Bushing

**Sampa Nr.**  
**020.131**

**O.E.M. Nr.**  
**81.41304.0050**  
**(81.41304.0035)**  
**(81.41304.0029)**



**Dimension**  
ø44xø48x95.5

**Description**  
Spring Bushing

14/15.220/15.240 - 17.170/192/220/240  
16.170/192/200/240/280/281/290/291/321/331/361  
19.240/281/291/321/331/361  
19T - F 90 - M 2000 - M 90

**Sampa Nr.**  
**020.143**

**O.E.M. Nr.**  
**81.41350.0018**



**Dimension**  
ø125/ø145x275

**Description**  
Cradle

26 T  
F 2000  
F 90  
ÖAF  
TGA

**Sampa Nr.**  
**020.209**

**O.E.M. Nr.**  
**06.36959.0027**  
**(06.36959.0030)**



**Dimension**  
ø95xø145x31/37

**Description**  
Joint Bearing

F90  
F 2000  
TGA

**Sampa Nr.**  
**020.156**

**O.E.M. Nr.**  
**81.41320.0092**  
**(81.41320.0089)**



**Dimension**  
184x220x217

**Description**  
Spring Bracket

26T/19T  
F 2000  
F 90  
M 2000  
ÖAF  
TGA

**Sampa Nr.**  
**020.176**

**O.E.M. Nr.**  
**81.96210.0508**  
**(81.96210.0507)**



**Dimension**  
ø121xø150x100

**Description**  
Bogie Suspension Bearing

F 2000  
TGA

**Sampa Nr.**  
**020.145**

**O.E.M. Nr.**  
**81.45503.0037**



**Dimension**  
M27x2/41

**Description**  
Nut for Spring Pin

26T  
F 2000

F 90  
M 2000

ÖAF  
TGA

# Cabin

**MAN**



*Sampa Nr.*

**020.028**

*O.E.M. Nr.*

**81.96210.0437  
(81.96210.0424)**

*Dimension*

ø16.5xø70.5x68

*Description*

Cabin Bushing

F 2000  
F 90  
M 2000  
ÖAF



*Sampa Nr.*

**020.032**

*O.E.M. Nr.*

**81.96210.0407  
(81.96210.0362)**

*Dimension*

ø15xø62x17

*Description*

Buffer for Cabin

F 2000  
F 90  
M 2000  
ÖAF



*Sampa Nr.*

**111.004**

*O.E.M. Nr.*

**06.36950.0510  
(81.93430.0008)  
(81.93430.0009)  
(81.93430.0010)**

*Dimension*

ø30xø47x18/22

*Description*

Cab Suspension Bearing

F 2000  
F 90  
M 2000  
ÖAF



*Sampa Nr.*

**020.034**

*O.E.M. Nr.*

**81.90713.0909  
(81.90712.0844)**

*Dimension*

ø33xø65x6

*Description*

Buffer for Cabin

F 2000  
F 90  
M 2000  
ÖAF



*Sampa Nr.*

**020.506**

*O.E.M. Nr.*

**81.96210.0407 S**

*Dimension*

ø16.5xø70.5x68

*Description*

Rep. Kit for Cabin

F 2000  
F 90  
M 2000  
ÖAF



*Sampa Nr.*

**020.513**

*O.E.M. Nr.*

**81.96210.0407 S1**

*Dimension*

ø16.5xø70.5x68

*Description*

Rep. Kit for Cabin

F 2000  
F 90  
M 2000  
ÖAF



Sampa Nr.

**020.031**

O.E.M. Nr.

**81.96210.0400**



Dimension

ø16xø50x29

Description

Cabin Mounting

F 90  
ÖAF

Sampa Nr.

**020.032**

O.E.M. Nr.

**81.96210.0407  
(81.96210.0362)**



Dimension

ø15xø62x17

Description

Buffer for Cabin

F 2000  
F 90  
M 2000  
ÖAF

Sampa Nr.

**111.004**

O.E.M. Nr.

**06.36950.0510  
(81.93430.0008)  
(81.93430.0009)  
(81.93430.0010)**



Dimension

ø30xø47x18/22

Description

Cab Suspension Bearing

F 2000  
F 90  
M 2000  
ÖAF

Sampa Nr.

**020.034**

O.E.M. Nr.

**81.90713.0909  
(81.90712.0844)**



Dimension

ø33xø65x6

Description

Buffer for Cabin

F 2000  
F 90  
M 2000  
ÖAF

Sampa Nr.

**020.505**

O.E.M. Nr.

**81.96210.0400 S**

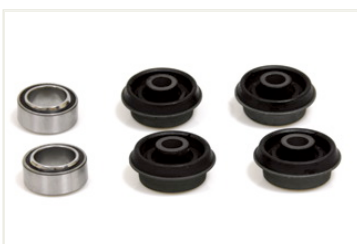

Dimension

ø16xø50x29

Description

Rep. Kit for Cabin

F 90  
ÖAF

Sampa Nr.

**020.514**

O.E.M. Nr.

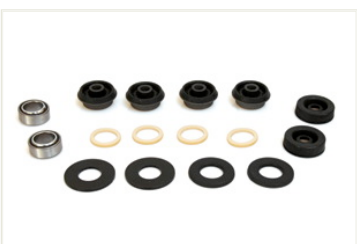

Dimension

ø16xø64x29

Description

Rep. Kit for Cabin

F 90  
ÖAF

# Cabin

MAN



Sampa Nr.

**020.174**

O.E.M. Nr.

**85.96210.0019**

Dimension

ø16.5x60x63.5x80

Description

Cabin Mounting

ECT18/26  
TGA



Sampa Nr.

**020.191**

O.E.M. Nr.

**85.41715.0006**

Dimension

ø16.5/ø30x29

Description

Cabin Bushing

ECT18/26  
TGA



Sampa Nr.

**020.175**

O.E.M. Nr.

**85.96210.0021**

Dimension

ø16xø53x58

Description

Cabin Mounting

ECT18/26  
TGA  
TGL  
TGM



Sampa Nr.

**111.070**

O.E.M. Nr.

**06.36950.0210**

Dimension

ø30xø47x18/22

Description

Cab Suspension Bearing



Sampa Nr.

**020.542**

O.E.M. Nr.

**81.41715.6014**

Dimension

ø16.5x63.5x60x80

Description

Rep. Kit for Cabin

ECT18/26  
TGA



Sampa Nr.

**020.544**

O.E.M. Nr.

**81.41715.6013**

Dimension

ø16.5x63.5x60x80

Description

Rep. Kit for Cabin

ECT18/26  
TGA





<b>Sampa Nr.</b>	
<b>020.141</b>	
<b>O.E.M. Nr.</b> <b>81.96210.0536</b>	
<b>Dimension</b>	M10/ø50.5x36
<b>Description</b>	Buffer for Cabin
F 2000 M 2000 ÖAF	

<b>Sampa Nr.</b>	
<b>020.182</b>	
<b>O.E.M. Nr.</b> <b>81.96210.0515</b> <b>(81.96210.0482)</b>	
<b>Dimension</b>	M10/ø50.5x36
<b>Description</b>	Buffer for Cabin
F 2000 M 2000 ÖAF	

<b>Sampa Nr.</b>	
<b>020.045</b>	
<b>O.E.M. Nr.</b> <b>81.96210.0348</b> <b>(81.96210.0340)</b> <b>(81.96210.0349)</b>	
<b>Dimension</b>	ø22xø58.5x47.5
<b>Description</b>	Cabin Mounting
12/14/16/17.170/192 18.220 322/352/402/422/462 FRH LION'S CITY LION'S CLASSIC LION'S COACH M 2000 M 90 RH 353/403/463	
SL 18.220/260/280 SUE 223/253/263/313 TGA	





<b>Sampa Nr.</b>	
<b>020.102</b>	
<b>O.E.M. Nr.</b> <b>81.96210.0353</b>	
<b>Dimension</b>	ø30.5xø88x85
<b>Description</b>	Cabin Mounting
14/15.220/15.240 16/17.220/240/19.240 16/19.281/291/321/331/361 22/24/25/26.220/240/281/291/321/331/361 26/30/32/33/34.281/291/321/331/361 26/32.365 27/32/33/34.281/291/321/331/361	

<b>Sampa Nr.</b>	
<b>020.048</b>	
<b>O.E.M. Nr.</b> <b>81.96210.0393</b> <b>(83.96210.0512)</b>	
<b>Dimension</b>	ø25/40
<b>Description</b>	Cabin Mounting
TGA 19T 26T	

<b>Sampa Nr.</b>	
<b>020.049</b>	
<b>O.E.M. Nr.</b> <b>81.96210.0392</b> <b>(83.96210.0515)</b>	
<b>Dimension</b>	ø25/52
<b>Description</b>	Cabin Mounting
19T 26T	

# Cabin

MAN

	<p><i>Sampa Nr.</i></p> <p><b>020.050</b></p> <p><i>O.E.M. Nr.</i></p> <p><b>85.96210.0012</b> (85.96210.0007) (81.96210.0012)</p>		<p><i>Sampa Nr.</i></p> <p><b>020.189</b></p> <p><i>O.E.M. Nr.</i></p> <p><b>81.96210.0316</b> (81.96210.0274)</p>
<p><i>Dimension</i></p> <p>ø22.5/ø94</p>		<p><i>Dimension</i></p> <p>ø20/153</p>	
<p><i>Description</i></p> <p>Cabin Mounting</p> <p>12.155 STAR 266M-STAR 8.125 STAR L 2000 M 2000</p>		<p><i>Description</i></p> <p>Cabin Mounting</p> <p>6/8.90                      G 90 8/9.136                    ÖAF</p>	
	<p><i>Sampa Nr.</i></p> <p><b>020.193</b></p> <p><i>O.E.M. Nr.</i></p> <p><b>81.96210.5011</b></p>		<p><i>Sampa Nr.</i></p> <p><b>020.033</b></p> <p><i>O.E.M. Nr.</i></p> <p><b>81.96210.0462</b> (81.96210.0369)</p>
<p><i>Dimension</i></p> <p>ø20/83</p>		<p><i>Dimension</i></p> <p>ø14xø30x48</p>	
<p><i>Description</i></p> <p>Cabin Mounting</p> <p>19.240 26.240/281/301/321 32.240/281/301/321</p>		<p><i>Description</i></p> <p>Cabin Mounting</p> <p>266M-STAR                      F 90                                      TGA AGGREGATE                    L 2000                                TGL ECT18/26                        M 2000                                TGM F 2000                              ÖAF</p>	
	<p><i>Sampa Nr.</i></p> <p><b>020.105</b></p> <p><i>O.E.M. Nr.</i></p> <p><b>81.96210.0339</b> (83.96210.0500)</p>		<p><i>Sampa Nr.</i></p> <p><b>020.212</b></p> <p><i>O.E.M. Nr.</i></p> <p><b>85.96210.0028</b></p>
<p><i>Dimension</i></p> <p>M16/ø129x91</p>		<p><i>Dimension</i></p> <p>ø16xø50x80</p>	
<p><i>Description</i></p> <p>Buffer for Cabin</p> <p>12.170/192 14.170/192 16.170/192 17.170/192</p>		<p><i>Description</i></p> <p>Cabin Bushing</p> <p>TGL TGM</p>	
		<p><i>Sampa Nr.</i></p> <p><b>020.214</b></p> <p><i>O.E.M. Nr.</i></p> <p><b>81.41722.6048</b> (81.41722.6051)</p>	<p><i>Sampa Nr.</i></p> <p><b>020.214</b></p> <p><i>O.E.M. Nr.</i></p> <p><b>81.41722.6048</b> (81.41722.6051)</p>
<p><i>Dimension</i></p> <p>M16/ø129x91</p>		<p><i>Dimension</i></p> <p>M16/ø129x91</p>	
<p><i>Description</i></p> <p>Buffer for Cabin</p> <p>12.170/192 14.170/192 16.170/192 17.170/192</p>		<p><i>Description</i></p> <p>Cabin Shock Absorber, With Air Bellow</p> <p>F 2000</p>	



<b>Sampa Nr.</b>	
<b>020.001</b>	
<b>O.E.M. Nr.</b>	
<b>81.43704.0025</b>	
	
<b>Dimension</b>	
ø55xø65x80.5	
<b>Description</b>	
Stabilizer Plastic Bearing	
12.170/192 14/15.220 15/19/26/32.240 16.200/240/280/290/360/372 16/17.170/192/220/240 16/19.281/291/321/331/361 22/24/25/26.220/240	22/24/25/26/27/32/33/34.281/291/3 21/331/361 26/30/32/33/34.281/291/321/331/3 61 26/32.301/365 M 90

<b>Sampa Nr.</b>	
<b>080.001</b>	
<b>O.E.M. Nr.</b>	
<b>81.43704.0026</b>	
	
<b>Dimension</b>	
ø38xø58/74	
<b>Description</b>	
Stabilizer Plastic Bearing	
16.200/240 16.240/280/290/360/372 16/19.281/291/321/331/361 22/24/25/26.281/291/321/331/361 26/32.281/301/321 26/27/32/33/34.281/291/321/331/361 30/32/33/34.281/291/321/331/361 22/24/25/26.220/240	14/15.220/15.240 16/17.220/240 19.240 H 26/32.240 26/32.365 19T4X4--- 16/17.220/240/19.240

<b>Sampa Nr.</b>	
<b>020.003</b>	
<b>O.E.M. Nr.</b>	
<b>81.43704.0029</b>	
	
<b>Dimension</b>	
ø45xø58/80	
<b>Description</b>	
Stabilizer Plastic Bearing	
ÖAF - M 90 - M 2000 - G 90 26/32/33/34.281/291/321/331/361 26/32.240/281/301/321/365 22/24/25/26/27/32/33/34.281/291/321/331/361 22/24/25/26.291/331/361 16/19.281/291/321/331/361 16/17/22/24/25/26.220/240 16.200/240/280/290/360/372 15/19.240 14/15.220 12/16/17.170/192	







<b>Sampa Nr.</b>	
<b>020.004</b>	
<b>O.E.M. Nr.</b>	
<b>81.43704.0032</b>	
	
<b>Dimension</b>	
ø60xø70/81	
<b>Description</b>	
Stabilizer Plastic Bearing	
14/15.220/15.240 16/17.220/240 16/19/22/24/25/26/30/32/33/34.281/291/321/331/361 22/24/25/26.220/240/291/331/361 F90	

<b>Sampa Nr.</b>	
<b>020.041</b>	
<b>O.E.M. Nr.</b>	
<b>81.43704.0053</b>	
	
<b>Dimension</b>	
ø35.5xø56.5x51.5	
<b>Description</b>	
Stabilizer Bearing	
6/8.90 8/9.136 8/9.136/170	G 90 L 2000 M 2000

<b>Sampa Nr.</b>	
<b>020.042</b>	
<b>O.E.M. Nr.</b>	
<b>81.43704.0052</b>	
	
<b>Dimension</b>	
ø31.5xø56.5x51.5	
<b>Description</b>	
Stabilizer Bearing	
6/8.90 F/FR G 90 L 2000	

# Stabilizer

MAN

	<p><b>Sampa Nr.</b> <b>020.192</b></p>		<p><b>Sampa Nr.</b> <b>020.006</b></p>
<p><b>Dimension</b> ø39xø56.5x51.5</p>	<p><b>O.E.M. Nr.</b> <b>81.43704.0038</b></p>	<p><b>Dimension</b> ø16xø45x42</p>	<p><b>O.E.M. Nr.</b> <b>81.43271.0029 (81.43271.0008)</b></p>
<p><b>Description</b> Stabilizer Bearing</p>		<p><b>Description</b> Stabilizer Rubber Bushing</p>	
<p>6/8.90 8/9.136/170 G 90 L 2000 M 2000</p>		<p>12/14/16.170/192 14/15.220 15/19/26/32.240 16.240/280/290/360/372 16/17/22/24/25/26.220/240 16/19.281/291/321/331/361 22/24/25/26/27/30/32/33/34.281/291/321/331/361 M 90</p>	
	<p><b>Sampa Nr.</b> <b>020.007</b></p>		<p><b>Sampa Nr.</b> <b>020.024</b></p>
<p><b>Dimension</b> ø22xø75x62</p>	<p><b>O.E.M. Nr.</b> <b>81.43722.0019 (81.43722.6051)</b></p>	<p><b>Dimension</b> ø22xø65.5x62</p>	<p><b>O.E.M. Nr.</b> <b>81.43722.0021</b></p>
<p><b>Description</b> Stabilizer Rubber Bushing</p>		<p><b>Description</b> Stabilizer Rubber Bushing</p>	
<p>22/24/25/26.291/331/361 F 2000 F 90 ÖAF TGA</p>		<p>22/24/25/26.291/331/361 F 2000 M 90 ÖAF</p>	
	<p><b>Sampa Nr.</b> <b>020.044</b></p>		<p><b>Sampa Nr.</b> <b>020.170</b></p>
<p><b>Dimension</b> ø18xø55x55</p>	<p><b>O.E.M. Nr.</b> <b>81.43271.0022</b></p>	<p><b>Dimension</b> ø32xø55x72</p>	<p><b>O.E.M. Nr.</b> <b>81.96210.0150</b></p>
<p><b>Description</b> Stabilizer Rubber Bushing</p>		<p><b>Description</b> Stabilizer Rubber Bushing</p>	
		<p>16.240/280/281/290/291/321/331/360/361/370/372 19.281/291/321/331/361 22/24/25/26.220/240/281/291/321/331/361 L 2000 M 2000</p>	

**Sampa Nr.**  
**020.204**

**O.E.M. Nr.**  
**81.43722.0022**



**Dimension**  
ø16xø45x47

**Description**  
Stabilizer Rubber Bushing

10/11.150/180/190/220/230 - 12.220  
13.210/220/230 - 14.220/280  
16.200/240/280/290/360/370/372  
18.220/260/280/310/313/350/360/370/400/410/420/460  
22/24.330-420  
24.310/350/400/460  
26/32/33/34.281/291/321/331/361 - 26T  
322/352/402/422/462 FRH  
CENTROLINER  
ECT18/26  
F 2000  
TGA  
TGL  
TGM  
F 90

**Sampa Nr.**  
**020.027**

**O.E.M. Nr.**  
**81.96210.0450**  
**(81.43722.0038)**  
**(81.96210.0469)**



**Dimension**  
ø16xø47.5x47

**Description**  
Stabilizer Mounting

G 90  
L 2000  
LION'S CITY  
LION'S CLASSIC  
M 2000  
M 90  
ND 313/363  
NG 243/263/313  
NL 223/242/243/263/283/313  
NMT 222 - NUE 263/313/353  
ÖAF - RH 353/403  
SG 28.260/310  
SL 18.220/260/280  
SUE 223/253/263/313  
UEL 242/272/292/312/322

**Sampa Nr.**  
**020.036**

**O.E.M. Nr.**  
**81.43722.0039**



**Dimension**  
ø22xø67.5x62

**Description**  
Stabilizer Mounting

F 2000	L 2000	M 90	TGA
F 90	M 2000	ÖAF	

**Sampa Nr.**  
**020.037**

**O.E.M. Nr.**  
**81.43722.0063**



**Dimension**  
ø22xø68x62

**Description**  
Stabilizer Mounting

12.220	F 2000	M 90	TGM
13.210/220/230	F 90	NMT 222	
14.220/280	L 2000	ÖAF	
ECT18/26	M 2000	TGA	

**Sampa Nr.**  
**020.039**

**O.E.M. Nr.**  
**81.43722.0040**  
**(81.43722.0041)**  
**(81.43722.0042)**



**Dimension**  
ø55xø83x70

**Description**  
Stabilizer Mounting

12/14.220	F 90	NMT 222
13.210/220/230	L 2000	ÖAF
26T	M 2000	TGA
F 2000	M 90	TGL

**Sampa Nr.**  
**020.169**

**O.E.M. Nr.**  
**81.43722.0059**



**Dimension**  
ø16xø50x47

**Description**  
Stabilizer Mounting

322/352/402/422/462 FRH  
18.220/260/280/290/310/313/350/360/370/400/410/420/460  
22/24.330-420 - 24.310/350/400/460 - 26T  
CENTROLINER - ECT18/26 - F 2000 - F 90 - L 2000  
LION'S CITY - LION'S COACH - LION'S REGIO - LION'S STAR  
M 2000 - M 90 - ND 313/363 - NG 243/263/313  
NL 223/242/243/263/283/313 - NM 223/283 - NUE 263/313/353  
ÖAF - RH 353/403/463  
STARLINER - TGA - TGL - TGM  
TOURLINER - TRENDLINER - UEL 242/272/292/312/313/322/353



# Stabilizer

MAN



Sampa Nr.

**020.172**

O.E.M. Nr.

**81.43722.0047**

Dimension

ø24xø64x44

Description

Stabilizer Mounting

12/14.220  
18.220/230/250/280/310/313/350/360/370/400/410/420/460  
24.310/350 - 28.270  
AGGREGATE - EL 202/222/262  
LION'S CLASSIC - ND 202 - NEW FLYER  
NG 232/235/252/262/272/312 - NGT 204  
NL 202/205/213/222/232/240/250/252/262/312 - NMT 222  
SG 28.260/310 - SL 18.220/260/280 - SUE 223/253/263/313  
UEL 242/272/292/312/322



Sampa Nr.

**020.012**

O.E.M. Nr.

**81.43271.0080**

Dimension

ø65.5xø15/100

Description

Silent Block for Stabilizer

18.220/290/370

F 2000

F 90

M 90

ÖAF



Sampa Nr.

**020.013**

O.E.M. Nr.

**81.43271.0082**

Dimension

ø65.5xø21/125

Description

Silent Block for Stabilizer

14/15.220	30/32/33/34.281/291/321/331/361
15/19.240	F 2000
16.200/220/240/280/290	F 90
16/19.281/291/321/331/361	ÖAF
17.220/240	TGA
26/32.240/281/291/301/321/331/361/365	
27/32/33/34.281/291/321/331/361	



Sampa Nr.

**020.014**

O.E.M. Nr.

**81.43271.0083**  
**(81.43271.0079)**  
**(81.43271.0046)**

Dimension

ø75xø21/125

Description

Silent Block for Stabilizer

F 2000

F 90

ÖAF



Sampa Nr.

**020.015**

O.E.M. Nr.

**81.43271.0087**

Dimension

ø65.5xø19/130

Description

Silent Block for Stabilizer

16.240/280/290/360/370/372  
22/24.330-420  
ÖAF



Sampa Nr.

**020.022**

O.E.M. Nr.

**81.96210.0452**

Dimension

ø47.5xø19/99

Description

Silent Block for Stabilizer

10/11.150/180/190/220/230

12.220

L 2000

M 2000

M 90



Sampa Nr.

**020.023**

O.E.M. Nr.

**81.43271.0078  
(81.43271.0032)**



Dimension

ø75xø19/130

Description

Silent Block for Stabilizer

14.220  
15/16/17/22/24/25/26.220/240  
16/19.281/291/321/331/361  
22/24/25/26/30/32/33/34.281/291/321/331/361

Sampa Nr.

**020.040**

O.E.M. Nr.

**81.96210.0511**



Dimension

ø47.5xø21/101

Description

Silent Block for Stabilizer

10/11.150/180/190/220/230  
12.220  
L 2000  
M 2000  
M 90

Sampa Nr.

**020.162**

O.E.M. Nr.

**81.43722.0072**



Dimension

ø68.5xø15/100

Description

Silent Block for Stabilizer

F 2000  
TGA

Sampa Nr.

**020.008**

O.E.M. Nr.

**81.43704.0057**



Dimension

ø44.5xø67x60

Description

Stabilizer Half Bushing

10/11.150/180/190/220/230  
12.220  
13.210/220/230  
16.200/240/280/290/360/370/372  
18.310/350/360/370/400/410/420/460  
22/24.330-420  
24.310/350/400/460  
CENTROLINER  
F 2000  
F 90  
L 2000  
LION'S CITY  
LION'S CLASSIC  
LION'S COACH  
LION'S STAR  
M 2000  
M 90  
MAN 322/352/402/422/462 FRH  
ÖAF  
RH 352/353/402/403/422/463  
SG 28.260/310  
SUE 223/253/263/313  
TOURLINER  
UEL 242/272/292/312/313/322/353

Sampa Nr.

**011.077**

O.E.M. Nr.

**81.43271.0081**



Dimension

ø54xø93.5/70x80







Description

Stabilizer Half Bushing

16.240/280/290/360/372  
18.220/290/370  
22/24.330-420  
26T6X6  
F 2000  
F 90  
ÖAF

# Stabilizer

MAN

	<p><i>Sampa Nr.</i></p> <p><b>020.009</b></p> <p><i>O.E.M. Nr.</i></p> <p><b>81.43704.0060</b></p>		<p><i>Sampa Nr.</i></p> <p><b>020.010</b></p> <p><i>O.E.M. Nr.</i></p> <p><b>81.43704.0061</b></p>	
<p><i>Dimension</i></p> <p>ø55xø78x60</p>		<p><i>Dimension</i></p> <p>ø60xø78x60</p>		
<p><i>Description</i></p> <p>Stabilizer Half Bushing</p>		<p><i>Description</i></p> <p>Stabilizer Half Bushing</p>		
<p>14.280 22/24/25/26.291/331/361 F90 L 2000 M 2000</p>		<p>14.280 18.220/290/370 22/24/25/26.291/331/361 ECT18/26 F 2000 F 90</p>		<p>L 2000 M 2000 ÖAF TGA</p>
	<p><i>Sampa Nr.</i></p> <p><b>020.046</b></p> <p><i>O.E.M. Nr.</i></p> <p><b>81.43704.0044</b> <b>(81.43704.0042)</b></p>		<p><i>Sampa Nr.</i></p> <p><b>020.047</b></p> <p><i>O.E.M. Nr.</i></p> <p><b>81.43704.0045</b> <b>(81.43704.0028)</b></p>	
<p><i>Dimension</i></p> <p>ø55xø82x80</p>		<p><i>Dimension</i></p> <p>ø55xø87x80</p>		
<p><i>Description</i></p> <p>Stabilizer Half Bushing</p>		<p><i>Description</i></p> <p>Stabilizer Half Bushing</p>		
		<p>SL 200 SR 240/280 SUE 240</p>		
	<p><i>Sampa Nr.</i></p> <p><b>020.159</b></p> <p><i>O.E.M. Nr.</i></p> <p><b>81.43722.0052</b></p>		<p><i>Sampa Nr.</i></p> <p><b>020.161</b></p> <p><i>O.E.M. Nr.</i></p> <p><b>81.43722.0053</b></p>	
<p><i>Dimension</i></p> <p>ø34.5xø55x60</p>		<p><i>Dimension</i></p> <p>ø39xø55x60</p>		
<p><i>Description</i></p> <p>Stabilizer Mounting</p>		<p><i>Description</i></p> <p>Stabilizer Mounting</p>		
<p>L 2000 M 2000</p>		<p>12.220 14.280 L 2000 M 2000</p>		



**Sampa Nr.**  
**020.160**

**O.E.M. Nr.**  
**81.43704.0078**



**Dimension**  
ø45xø75x51

**Description**  
Stabilizer Mounting

18.260/310/313/350/360/370/400/410/420/460  
322/352/402/422/462 FRH  
ECT18/26 - F 2000  
LION'S CITY - LION'S COACH - LION'S REGIO - LION'S STAR  
ND 313/363 - NM 223/283  
RH 353/403  
STARLINER - TOURLINER - TRENDLINER  
UEL 313/353 - TGA

**Sampa Nr.**  
**020.163**

**O.E.M. Nr.**  
**81.43704.0077**

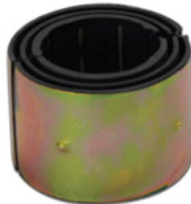

**Dimension**  
ø50xø75x51

**Description**  
Stabilizer Mounting

12.220 ND 313/363  
14.220/280 NG 243/263/313  
18.220/260/280/310 NL 223/242/243/263/283/313  
CENTROLINER NUE 263/313/353  
ECT26 TGA  
L 2000 TGL  
LION'S CITY TGM

**Sampa Nr.**  
**020.180**

**O.E.M. Nr.**  
**81.43722.0083**



**Dimension**  
ø60xø88x60

**Description**  
Stabilizer Mounting

ECT18/26  
F 2000  
TGA  
TGM

**Sampa Nr.**  
**020.183**

**O.E.M. Nr.**  
**81.43722.0068**  
**(81.43722.0069)**  
**(81.43722.0080)**



**Dimension**  
ø50xø84x72

**Description**  
Stabilizer Mounting

F 2000  
L 2000  
ÖAF  
TGA  
TGM

**Sampa Nr.**  
**020.184**

**O.E.M. Nr.**  
**81.43704.0074**



**Dimension**  
ø45xø65x51

**Description**  
Stabilizer Mounting

18.220/260/290/310/313/350/360/370/400/410/420/460  
26T  
F 2000  
M 2000  
ÖAF

**Sampa Nr.**  
**020.177**

**O.E.M. Nr.**  
**81.95301.0048**



**Dimension**  
ø83/46





**Description**  
Stabilizer Mounting

GS UEH 270/290/320/370  
MAN 292/332/362  
SG 242/282/292/322  
SL 202  
SR 240/280  
SUE 240/242/280



# Stabilizer

**MAN**

	<p><i>Sampa Nr.</i></p> <p><b>020.016</b></p>		<p><i>Sampa Nr.</i></p> <p><b>020.017</b></p>
<p><i>Dimension</i></p> <p>ø55xø75x83</p>	<p><i>O.E.M. Nr.</i></p> <p><b>81.43271.0033</b></p>	<p><i>Dimension</i></p> <p>ø42xø68x68</p>	<p><i>O.E.M. Nr.</i></p> <p><b>81.43271.0074 (81.43271.0056)</b></p>
<p><i>Description</i></p> <p>Stabilizer Mounting</p>		<p><i>Description</i></p> <p>Stabilizer Mounting</p>	
<p>SG 242/280/282/292/322 SL 200/ 202 SR 280 SUE 240/242/280</p>		<p>SL 200 SR 240/280 SUE 240/280</p>	
	<p><i>Sampa Nr.</i></p> <p><b>020.018</b></p>		<p><i>Sampa Nr.</i></p> <p><b>020.019</b></p>
<p><i>Dimension</i></p> <p>ø55xø75x83</p>	<p><i>O.E.M. Nr.</i></p> <p><b>81.43316.0021</b></p>	<p><i>Dimension</i></p> <p>ø42xø68x68</p>	<p><i>O.E.M. Nr.</i></p> <p><b>81.44204.0012 (81.44204.0004)</b></p>
<p><i>Description</i></p> <p>Stabilizer Mounting</p>		<p><i>Description</i></p> <p>Stabilizer Mounting</p>	
<p>322/352/402/422/462 FRH 16.360/372 22/24.330-420 24.400/460 GS UEH 270/290/320/370 SG 242/280/292/322 SL 200/202 SUE 240/242/280</p>			
	<p><i>Sampa Nr.</i></p> <p><b>020.020</b></p>		<p><i>Sampa Nr.</i></p>
<p><i>Dimension</i></p> <p>ø58xø80x68</p>	<p><i>O.E.M. Nr.</i></p> <p><b>81.44204.0021 (81.44204.0020)</b></p>	<p><i>Dimension</i></p>	<p><i>O.E.M. Nr.</i></p>
<p><i>Description</i></p> <p>Stabilizer Mounting</p>		<p><i>Description</i></p>	
<p>322/352/402/422/462 FRH 16.360/372 22/24.330-420 24.400/460 GS UEH 270/290/320/370 LION'S COACH</p> <p>MAN 292/332/362 SG 242/280/282/292/322 SL 200/202 SR 240/280 SUE 240/242/280</p>			



Sampa Nr.

**020.043**

O.E.M. Nr.

**81.96210.0278**



Dimension  
ø27x43

Description

Stabilizer Bearing

6/8.90  
8/9.136/170  
G 90  
L 2000  
M 2000

Sampa Nr.

**020.035**

O.E.M. Nr.

**81.96020.0286**



Dimension  
ø14xø37.5x51

Description

Stabilizer Rubber Bushing

6/8.90 F/FR  
8/9.136/170  
G 90  
L 2000  
M 2000

Sampa Nr.

**020.080**

O.E.M. Nr.

**81.96210.0294**



Dimension  
ø12xø33.5x32

Description

Stabilizer Rubber Bushing

6/8.90  
8/9.136/170  
G 90  
L 2000  
M2000 M

Sampa Nr.

O.E.M. Nr.

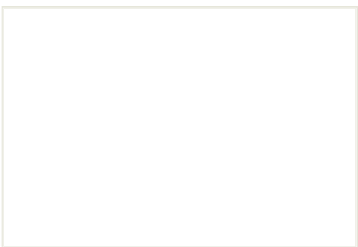

Dimension

Description

Sampa Nr.

**020.526**

O.E.M. Nr.

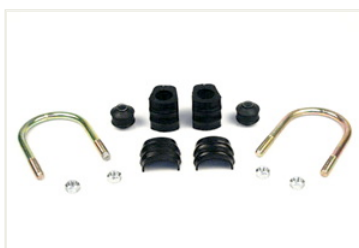

Dimension

Description

Stabilizer Bearing Kit

6/8.90  
8/9.136/170  
G 90  
L 2000  
M 2000

Sampa Nr.

O.E.M. Nr.

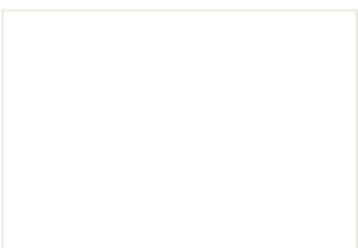

Dimension

Description

# Brake

MAN



**Sampa Nr.**  
**111.005**

**O.E.M. Nr.**  
**06.36959.0014**  
**(06.36959.0011)**  
**(06.36959.0018)**  
**(81.93430.0004)**

**Dimension**  
ø42xø62x20/25

**Description**  
Ball Bearing for Brake



**Sampa Nr.**  
**010.600**

**O.E.M. Nr.**  
**81.50212.0036 S**

**Dimension**  
ø30

**Description**  
Rep. Kit for Brake Shoe



**Sampa Nr.**  
**020.531**

**O.E.M. Nr.**  
**81.51901.6006**

**Dimension**  
ø42

**Description**  
Rep. Kit for Camshaft

322/352/402/422/462 FRH ... / 33/34.281/291/321/331/361  
EL 202/222/262 - F 2000 - F 90 - M 2000 - M 90 - L 2000  
LION'S CLASSIC - MAN 292/332/362  
ND/NG/NGT/NL/NM/SD/SG/SL/GS/SL/SUE/UEL/ÖAF



**Sampa Nr.**  
**010.682**

**O.E.M. Nr.**  
**81.50213.6006 S**

**Dimension**  
ø20

**Description**  
Rep. Kit for Brake Shoe

10/11.150/180/190/220/230 - 14.170/192 - 14/15.220/15.240  
F 2000 - F 90 - L 2000 -TGA - ÖAF  
GS UEH 270/290/320/370  
LION'S CITY - LION'S CLASSIC - LION'S COACH - NEW FLYER  
M 2000 - M 90 - ND 202 - MAN 292/332/362

LION'S CLASSIC	M 90	L 2000
ÖAF	NEW FLYER	F 2000
M 2000	TGA	F 90



**Sampa Nr.**  
**010.592**

**O.E.M. Nr.**  
**81.51901.6005**

**Dimension**  
ø42

**Description**  
Rep. Kit for Camshaft

322/352/402/422/462 FRH	F 90	LION'S CLASSIC
33/34.281/291/321/331/361	L 2000	MAN 292/332/362
EL 202/222/262	M 2000	ND/NG/GS/NGT/NL/NM/SL/SD/SG/SUE/UEL/ÖAF
F 2000	M 90	



**Sampa Nr.**  
**010.593**

**O.E.M. Nr.**  
**06.36959.0014 S**

**Dimension**  
ø42

**Description**  
Rep. Kit for Camshaft



**Sampa Nr.**  
**100.089**

**O.E.M. Nr.**  
**81.97610.0208**  
**(81.97610.0118)**

**Dimension**  
ø26x243

**Description**  
Brake Shoe Spring

14.170/192/220 - 15.220/15.240 ...  
34.281/291/321/331/361  
F 2000 - F 90 - L 2000 - M 2000 - M 90 - ÖAF - SL 200 - SUE



**Sampa Nr.**  
**100.090**

**O.E.M. Nr.**  
**81.97610.0115**  
**(81.97610.0123)**

**Dimension**  
ø26x234

**Description**  
Brake Shoe Spring

14.220 - 15.220/240 ... - 30.281/291/321/331/361  
322/352/402/422/462 FRH - EL 202/222/262 - F 2000  
LION'S CITY - LION'S CLASSIC - NEW FLYER  
MAN 292/332/362  
NG - NL - NM - ÖAF - SD - SG - SL - SR - SUE - UEL



<b>Sampa Nr.</b>	
<b>020.197</b>	
<b>O.E.M. Nr.</b>	
<b>81.97610.0271</b>	
<b>Dimension</b>	ø30x240

**Description**  
Brake Shoe Spring

16.200/220/240/280/281/290/291/321/331/360/361/370/372  
17.220/240  
18.310/350/370/400/420/460 - 19.240/281/291/321/331/361  
22/24.330-420 - 22/24/25/26.291/331/361  
24.310/350/400/460  
26/32.240 - 26/32.281/301/321/365  
F 2000 - F 90 - L 2000 - M 2000 - M 90  
TGA  
ÖAF

<b>Sampa Nr.</b>	
<b>020.207</b>	
<b>O.E.M. Nr.</b>	
<b>81.97610.0001</b>	
<b>Dimension</b>	ø27x210

**Description**  
Return Spring

14.220  
15.220/240  
16.200/220/240/280/281/290/291/321/331/360/361/370/372  
17.220/240  
19.281/291/321/331/361  
19/26/32.240  
22.220/240/281/291/321/331/361  
22/24.330-420  
24.220/240/281/291/321/331/361  
25.220/240/281/291/321/331/361  
26.220/240/281/291/301/321/331/361/365  
27/30/33/34.281/291/321/331/361  
32.281/291/301/321/331/361/365

<b>Sampa Nr.</b>	
<b>020.195</b>	
<b>O.E.M. Nr.</b>	
<b>81.50101.5141 (81.50101.5142)</b>	
<b>Dimension</b>	ø265xø452x40

**Description**  
Dust Cover

18.220/230/250/290/310/313/350/370/400/420/460 - 19T  
24.350/400 - 28.270  
F 2000 - F 90 - L 2000 - M 2000 - M 90 - ÖAF  
LION'S CLASSIC  
NEW FLYER  
SG 28.260/310  
SL 18.220/260/280  
SUE 223/253/263/313  
UEL 242/272/292/312/322

<b>Sampa Nr.</b>	
<b>116.015</b>	
<b>O.E.M. Nr.</b>	
<b>81.93021.0117 (81.93021.0141) (81.93021.0142) (81.93021.0311)</b>	
<b>Dimension</b>	ø30xø34x47.5

**Description**  
Brake Shoe Bushing

10/11.150/180/190/220/230 - 14/15.220/15.240  
16.170/192/200/220/240/280/281/290/291/321/331/360/361/370/372  
17.170/192/220/240  
18.220/230/250/260/280/290/310/313/350/370/400/420/460  
19.240/281/291/321/331/361 - 19T  
22.220/240/281/291/321/331/361 - 22/24.330-420  
24.220/240/281/291/310/321/331/350/361/400/460  
25.220/240/281/291/321/331/361  
26.220/240/281/291/301/321/331/361/365 - 26T  
27/33/34.281/291/321/331/361  
28.270  
30/32/33/34.281/291/321/331/361  
32.240/281/291/301/321/331/361/365  
322/352/402/422/462 FRH  
EL 202/222/262  
GS UEH 270/290/320/370  
LION'S CITY - LION'S CLASSIC - LION'S COACH - NEW FLYER  
M 2000 - M 90 - F 2000 - F 90 - L 2000 -TGA - TGM - ÖAF  
MAN 292/332/362  
ND202  
NG 232/235/242/252/262/272/312 - NGT 204  
NL 202/205/213/222/232/240/250/252/262/312 - NM 152  
SD 202  
SG 242/280/282/292/322 - SG 28.260/310  
SL 18.220/260/280 - SL 200/202  
SR 240/280  
SUE 223/240/242/253/263/280/313  
UEL 242/272/292/312/322

<b>Sampa Nr.</b>	
<b>020.087</b>	
<b>O.E.M. Nr.</b>	
<b>81.96210.0132</b>	
<b>Dimension</b>	M10/ø50x45









**Description**  
Rubber Buffer for Brake Pressure Regulator

18.220/290/370 - 26/32.240/281/291/301/321/331/361/365  
27/30/32/33/34.281/291/321/331/361 - ÖAF





# Brake

MAN

	<p><i>Sampa Nr.</i></p> <p><b>095.509</b></p> <p><i>O.E.M. Nr.</i></p> <p><b>MCK-1171/N</b></p>		<p><i>Sampa Nr.</i></p> <p><b>095.510</b></p> <p><i>O.E.M. Nr.</i></p> <p><b>MCK-1102/N</b></p>
<p><i>Dimension</i></p>		<p><i>Dimension</i></p>	
<p><i>Description</i></p> <p>Rep. Kit for Brake Caliper</p>		<p><i>Description</i></p> <p>Rep. Kit for Brake Caliper</p>	
	<p><i>Sampa Nr.</i></p> <p><b>095.511</b></p> <p><i>O.E.M. Nr.</i></p> <p><b>MCK 1253</b></p>		<p><i>Sampa Nr.</i></p> <p><b>095.512</b></p> <p><i>O.E.M. Nr.</i></p> <p><b>MCK 1254</b></p>
<p><i>Dimension</i></p>		<p><i>Dimension</i></p>	
<p><i>Description</i></p> <p>Rep. Kit for Brake Caliper</p>		<p><i>Description</i></p> <p>Rep. Kit for Brake Caliper</p>	
	<p><i>Sampa Nr.</i></p> <p><b>095.513</b></p> <p><i>O.E.M. Nr.</i></p> <p><b>MCK 1139</b></p>		<p><i>Sampa Nr.</i></p> <p><b>095.514</b></p> <p><i>O.E.M. Nr.</i></p> <p><b>MCK 1238</b></p>
<p><i>Dimension</i></p>		<p><i>Dimension</i></p>	
<p><i>Description</i></p> <p>Rep. Kit for Brake Caliper</p>		<p><i>Description</i></p> <p>Rep. Kit for Brake Caliper</p>	
	<p><i>Sampa Nr.</i></p> <p><b>095.515</b></p> <p><i>O.E.M. Nr.</i></p> <p><b>MCK 1171</b></p>		<p><i>Sampa Nr.</i></p> <p><b>095.516</b></p> <p><i>O.E.M. Nr.</i></p> <p><b>MCK 1192</b></p>
<p><i>Dimension</i></p>		<p><i>Dimension</i></p>	
<p><i>Description</i></p> <p>Rep. Kit for Brake Caliper</p>		<p><i>Description</i></p> <p>Rep. Kit for Brake Caliper</p>	

<i>Sampa Nr.</i>	
<b>095.524</b>	
<i>O.E.M. Nr.</i> <b>K 001300</b>	
<i>Dimension</i>	
<i>Description</i>	
Rep. Kit for Brake Caliper	

<i>Sampa Nr.</i>	
<b>095.572</b>	
<i>O.E.M. Nr.</i> <b>K 010603</b>	
<i>Dimension</i>	
<i>Description</i>	
Rep. Kit for Brake Caliper	

<i>Sampa Nr.</i>	
<b>095.573</b>	
<i>O.E.M. Nr.</i> <b>K 010604</b>	
<i>Dimension</i>	
<i>Description</i>	
Rep. Kit for Brake Caliper	

<i>Sampa Nr.</i>	
<b>095.581</b>	
<i>O.E.M. Nr.</i> <b>K 000944</b>	
<i>Dimension</i>	
<i>Description</i>	
Rep. Kit for Brake Caliper	

<i>Sampa Nr.</i>	
<b>095.521</b>	
<i>O.E.M. Nr.</i> <b>II 304130065</b>	
<i>Dimension</i>	
<i>Description</i>	
Rep. Kit for Brake Caliper	







<i>Sampa Nr.</i>	
<b>095.519</b>	
<i>O.E.M. Nr.</i> <b>K 000696</b>	
<i>Dimension</i>	
<i>Description</i>	
Rep. Kit for Brake Caliper	

<i>Sampa Nr.</i>	
<b>095.520</b>	
<i>O.E.M. Nr.</i> <b>K 000687</b>	
<i>Dimension</i>	
<i>Description</i>	
Rep. Kit for Brake Caliper	

<i>Sampa Nr.</i>	
<b>095.525</b>	
<i>O.E.M. Nr.</i> <b>II 358510062</b>	
<i>Dimension</i>	
<i>Description</i>	
Rep. Kit for Brake Caliper	

# Brake

MAN

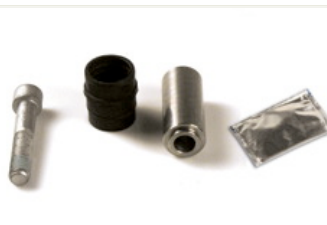
 <p><i>Dimension</i></p>	<p><i>Sampa Nr.</i></p> <p><b>095.530</b></p> <p><i>O.E.M. Nr.</i></p> <p><b>K 001274</b></p>	 <p><i>Dimension</i></p>	<p><i>Sampa Nr.</i></p> <p><b>095.531</b></p> <p><i>O.E.M. Nr.</i></p> <p><b>K 000375</b></p>
<p><i>Description</i></p> <p>Rep. Kit for Brake Caliper</p>		<p><i>Description</i></p> <p>Rep. Kit for Brake Caliper</p>	
 <p><i>Dimension</i></p>	<p><i>Sampa Nr.</i></p> <p><b>095.533</b></p> <p><i>O.E.M. Nr.</i></p> <p><b>II 339680062</b>  <b>(II 328090062)</b>  <b>(II 369100062)</b></p>	 <p><i>Dimension</i></p>	<p><i>Sampa Nr.</i></p> <p><b>095.568</b></p> <p><i>O.E.M. Nr.</i></p> <p><b>K 000472</b></p>
<p><i>Description</i></p> <p>Rep. Kit for Brake Caliper</p>		<p><i>Description</i></p> <p>Rep. Kit for Brake Caliper</p>	
 <p><i>Dimension</i></p>	<p><i>Sampa Nr.</i></p> <p><b>095.569</b></p> <p><i>O.E.M. Nr.</i></p> <p><b>K 001925</b></p>	 <p><i>Dimension</i></p>	<p><i>Sampa Nr.</i></p> <p><b>095.570</b></p> <p><i>O.E.M. Nr.</i></p> <p><b>K 001532</b></p>
<p><i>Description</i></p> <p>Rep. Kit for Brake Caliper</p>		<p><i>Description</i></p> <p>Rep. Kit for Brake Caliper</p>	
 <p><i>Dimension</i></p>	<p><i>Sampa Nr.</i></p> <p><b>095.526</b></p> <p><i>O.E.M. Nr.</i></p> <p><b>93161192</b></p>	 <p><i>Dimension</i></p>	<p><i>Sampa Nr.</i></p> <p><b>095.518</b></p> <p><i>O.E.M. Nr.</i></p> <p><b>II 368470064</b></p>
<p><i>Description</i></p> <p>Rep. Kit for Brake Caliper</p>		<p><i>Description</i></p> <p>Rep. Kit for Brake Caliper</p>	

<i>Sampa Nr.</i>	
<b>095.527</b>	
<i>O.E.M. Nr.</i> <b>II 197140062</b>	
<i>Description</i>	<i>Dimension</i>
Rep. Kit for Brake Caliper	

<i>Sampa Nr.</i>	
<b>095.528</b>	
<i>O.E.M. Nr.</i> <b>II 179320062</b>	
<i>Description</i>	<i>Dimension</i>
Rep. Kit for Brake Caliper	

<i>Sampa Nr.</i>	
<b>095.529</b>	
<i>O.E.M. Nr.</i> <b>II 197330062</b>	
<i>Description</i>	<i>Dimension</i>
Rep. Kit for Brake Caliper	

<i>Sampa Nr.</i>	
<b>095.522</b>	
<i>O.E.M. Nr.</i> <b>II 39769F0063</b>	
<i>Description</i>	<i>Dimension</i>
Rep. Kit for Brake Caliper	

<i>Sampa Nr.</i>	
<b>095.571</b>	
<i>O.E.M. Nr.</i> <b>K 001301</b>	
<i>Description</i>	<i>Dimension</i>
Rep. Kit for Brake Caliper	



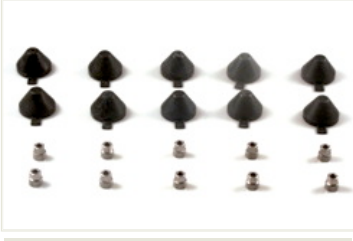

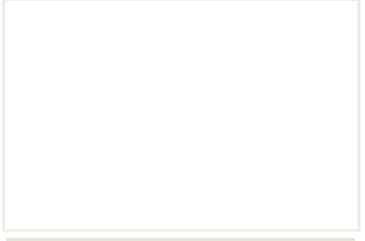







<i>Sampa Nr.</i>	
<b>095.523</b>	
<i>O.E.M. Nr.</i> <b>K 000945</b>	
<i>Description</i>	<i>Dimension</i>
Rep. Kit for Brake Caliper	

<i>Sampa Nr.</i>	
<b>095.567</b>	
<i>O.E.M. Nr.</i> <b>K 000029</b>	
<i>Description</i>	<i>Dimension</i>
Rep. Kit for Brake Caliper	

<i>Sampa Nr.</i>	
<i>O.E.M. Nr.</i>	
<i>Description</i>	<i>Dimension</i>

# DIAPHRAGMS

MAN

	<p><i>Sampa Nr.</i> <b>095.101</b></p> <p><i>O.E.M. Nr.</i> <b>897 120 492.4</b></p>		<p><i>Sampa Nr.</i> <b>095.108</b></p> <p><i>O.E.M. Nr.</i> <b>897 120 540.4</b></p>
<p><b>Type 9" Short</b></p> <p><i>Description</i> Short Stroke</p>		<p><b>Type 30" Short</b></p> <p><i>Description</i> Short Stroke</p>	
	<p><i>Sampa Nr.</i> <b>095.103</b></p> <p><i>O.E.M. Nr.</i> <b>897 120 505.4</b></p>		<p><i>Sampa Nr.</i> <b>095.109</b></p> <p><i>O.E.M. Nr.</i> <b>897 120 550.4</b></p>
<p><b>Type 12" Short</b></p> <p><i>Description</i> Short Stroke</p>		<p><b>Type 36" Short</b></p> <p><i>Description</i> Short Stroke</p>	
	<p><i>Sampa Nr.</i> <b>095.105</b></p> <p><i>O.E.M. Nr.</i> <b>897 120 510.4</b></p>		<p><i>Sampa Nr.</i> <b>095.110</b></p> <p><i>O.E.M. Nr.</i> <b>897 120 516.4</b></p>
<p><b>Type 16" Short</b></p> <p><i>Description</i> Short Stroke</p>		<p><b>Type 16" Long</b></p> <p><i>Description</i> Long Stroke</p>	
	<p><i>Sampa Nr.</i> <b>095.106</b></p> <p><i>O.E.M. Nr.</i> <b>897 120 520.4</b></p>		<p><i>Sampa Nr.</i> <b>095.111</b></p> <p><i>O.E.M. Nr.</i> <b>897 120 526.4</b></p>
<p><b>Type 20" Short</b></p> <p><i>Description</i> Short Stroke</p>		<p><b>Type 20" Long</b></p> <p><i>Description</i> Long Stroke</p>	
	<p><i>Sampa Nr.</i> <b>095.107</b></p> <p><i>O.E.M. Nr.</i> <b>897 120 530.4</b></p>		<p><i>Sampa Nr.</i> <b>095.112</b></p> <p><i>O.E.M. Nr.</i> <b>897 120 536.4</b></p>
<p><b>Type 24" Short</b></p> <p><i>Description</i> Short Stroke</p>		<p><b>Type 24" Long</b></p> <p><i>Description</i> Long Stroke</p>	
	<p><i>Sampa Nr.</i> <b>095.107</b></p> <p><i>O.E.M. Nr.</i> <b>897 120 530.4</b></p>		<p><i>Sampa Nr.</i> <b>095.113</b></p> <p><i>O.E.M. Nr.</i> <b>897 120 546.4</b></p>
<p><b>Type 24" Short</b></p> <p><i>Description</i> Short Stroke</p>		<p><b>Type 30" Long</b></p> <p><i>Description</i> Long Stroke</p>	



<p><b>Sampa Nr.</b></p> <p><b>100.033</b></p> <p><b>O.E.M. Nr.</b></p> <p><b>81.35710.0094</b> <b>(81.35710.0044)</b></p> <p><b>Description</b></p> <p>Thrust Washer (No Hardening)</p>	<p><b>Dimension</b></p> <p>ø115xø145x32</p>	<p><b>Sampa Nr.</b></p> <p><b>100.033/1</b></p> <p><b>O.E.M. Nr.</b></p> <p><b>81.35710.0094 S</b> <b>(81.35710.0044 S)</b></p> <p><b>Description</b></p> <p>Thrust Washer (Surface Hardened)</p>	<p><b>Dimension</b></p> <p>ø115xø145x32</p>
<p>19T/26T EL 202/222/262 ND 202 NG 232/235/242/252/262/272/312</p>		<p>NGT 204 NL 202/213/222/232/240/250/252/262/312</p>	
<p><b>Sampa Nr.</b></p> <p><b>100.035</b></p> <p><b>O.E.M. Nr.</b></p> <p><b>81.35710.0093</b> <b>(81.35710.0045)</b></p> <p><b>Description</b></p> <p>Thrust Washer (No Hardening)</p>	<p><b>Dimension</b></p> <p>ø110xø145x32</p>	<p><b>Sampa Nr.</b></p> <p><b>100.035/1</b></p> <p><b>O.E.M. Nr.</b></p> <p><b>81.35710.0093 S</b> <b>(81.35710.0045 S)</b></p> <p><b>Description</b></p> <p>Thrust Washer (Surface Hardened)</p>	<p><b>Dimension</b></p> <p>ø110xø145x32</p>
<p>16.200/240/280/290/360/370/372 22/24.330-420 27/30/33/34.281/291/321/331/361 26.281/291/321/331/361/365 32.281/291/321/331/361/365 EL 202/222/262 F 90 ND 202</p>		<p>NG 232/235/242/252/262/272/312 NGT 204 NL 202/205/213/222/232/240/250/252/262/312 SD 202 SL 200 SR 240/280 SUE 240/280</p>	
<p><b>Sampa Nr.</b></p> <p><b>020.101</b></p> <p><b>O.E.M. Nr.</b></p> <p><b>81.41401.0036</b></p> <p><b>Description</b></p> <p>Axle Buffer</p>	<p><b>Dimension</b></p> <p>ø81x332x81</p>	<p><b>Sampa Nr.</b></p> <p><b>020.198</b></p> <p><b>O.E.M. Nr.</b></p> <p><b>81.93001.0319</b></p> <p><b>Description</b></p> <p>Axle Bearing Bushing</p>	<p><b>Dimension</b></p> <p>ø40.5xø44.5x32</p>
<p>26.281/291/301/321/331/361 32.281/291/301/321/331/361 33.281/291/321/331/361 34.281/291/321/331/361</p>		<p>F 2000 F 90 L 2000</p> <p>M 2000 M 90 ÖAF</p>	

# Wheel - Axle

**MAN**



**Sampa Nr.**  
**010.680**  
**O.E.M. Nr.**  
**81.36305.0015 S**

**Dimension**  
ø50x109

**Description**  
King Pin Set

16.170/192	L 2000
16/17.220/240/19.240	M 2000
16/19.281/291/321/331/361	M 90
26/27/32/33/34.281/291/321/331/361	ÖAF
26/32.240/321	TGA
F 2000	
F 90	



**Sampa Nr.**  
**010.681**  
**O.E.M. Nr.**  
**81.36305.0014 S**  
**(81.36305.0016 S)**  
**(81.36305.6001 S)**

**Dimension**  
ø50xø64x119

**Description**  
King Pin Set

16.170/192 - 6/17.220/240/19.240 - 16/19.281/291/321/331/361  
26/27/32/33/34.291/331/361 - 26/32.240/281/301/321  
F 2000 - F 90 - L 2000 - M 2000 - M 90 - TGA - ÖAF



**Sampa Nr.**  
**020.517**  
**O.E.M. Nr.**  
**81.44205.6010**

**Dimension**  
ø49.5/ø50x223

**Description**  
King Pin Set

16.170/192/200/240/280/281/290/291/321/331/360/361/372  
17.170/192  
19.240/281/291/321/331/361  
22.220/240/281/291/321/331/361  
24.220/240/281/291/321/331/361  
25.220/240/281/291/321/331/361  
26.220/240/281/291/301/321/331/361/365  
30.281/291/321/331/361  
32.240/281/291/321/301/331/361/365  
33.281/291/321/331/361  
34.281/291/321/331/361  
SG 280/292  
SL 200  
SR 240/280  
SUE 240/280



**Sampa Nr.**  
**020.518**  
**O.E.M. Nr.**  
**81.44205.6013**

**Dimension**  
ø49.5xø50x223

**Description**  
King Pin Set

16.170/192/200/240/280/281/290/291/321/331/360/361/370/372  
... 32.240/281/291/301/321/331/361/365 - 322/352/402/422/462 FRH  
F 2000 - F 90 - L 2000 - M 2000 - M 90 - ÖAF  
LION'S CLASSIC - LION'S COACH - NEW FLYER  
ND/NG/NGT/NL/NM/SD/SG/SL/SR/SUE/UEL



**Sampa Nr.**  
**020.518/1**  
**O.E.M. Nr.**  
**81.44205.6013 S**

**Dimension**  
ø49.5xø50x223

**Description**  
King Pin Set



**Sampa Nr.**  
**020.520**  
**O.E.M. Nr.**  
**81.44205.6016**

**Dimension**  
ø34.5/ø35x174.5

**Description**  
King Pin Set

G 90



**Sampa Nr.**  
**020.521**  
**O.E.M. Nr.**  
**81.44205.6024**

**Dimension**  
ø29.5/ø30x156

**Description**  
King Pin Set



**Sampa Nr.**  
**020.527**

**O.E.M. Nr.**  
**81.44205.6009**



**Dimension**  
ø44.5/ø45x213

**Description**  
King Pin Set

14.170/192/220  
15.220/240  
16.170/192/220/240/281/291/321/331/361  
17.170/192/220/240  
19/30/33/34.281/291/321/331/361  
26/32.240/281/291/301/321/331/361  
F 90  
M 90  
ÖAF

**Sampa Nr.**  
**020.528**

**O.E.M. Nr.**  
**81.44205.6018**



**Dimension**  
ø37.5/ø38x192

**Description**  
King Pin Set

10.150/180/190/220/230 - 11.150/180/190/220/230  
12.170/192 - 13.210/220/230 - M 90

**Sampa Nr.**  
**020.533**

**O.E.M. Nr.**  
**81.44205.6023**



**Dimension**  
ø50xø51x223

**Description**  
King Pin Set

18.220/230/250/260/280/290/310/313/350/360/370/400/410/420/460  
F 2000 - L 2000 - M 2000 - ÖAF  
LION'S CITY - LION'S CLASSIC  
NG/NL/SG/SL/SUE/UEL / NUE

**Sampa Nr.**  
**020.532**

**O.E.M. Nr.**  
**81.44205.6025**



**Dimension**  
ø35/ø36x172

**Description**  
King Pin Set

L 2000  
M 2000

**Sampa Nr.**  
**020.547**

**O.E.M. Nr.**  
**81.44205.6027**

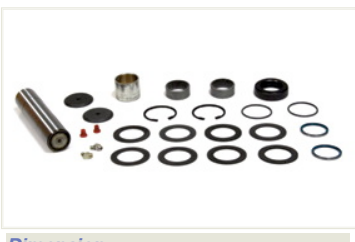

**Dimension**  
ø43x200

**Description**  
King Pin Set

12/14.220  
14.280  
L 2000

M 2000  
NMT 222

**Sampa Nr.**  
**020.540**

**O.E.M. Nr.**  
**81.44205.6020**



**Dimension**  
ø34.5xø35x174.5

**Description**  
King Pin Set

L 2000

**Sampa Nr.**  
**020.548**

**O.E.M. Nr.**  
**81.44205.6030**

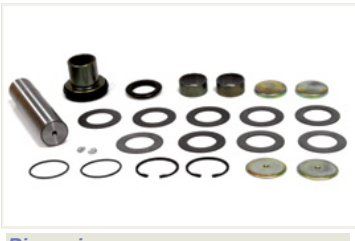

**Dimension**  
ø53x235

**Description**  
King Pin Set

LION'S...  
CENTROLINER  
TGA - TGM

TOURLINER  
TRENDLINER  
ND/NG/NL/NM/NUE/UEL

18.220/260/280/310  
ECT18/26

# V-Stay - Axle Control Arm

MAN

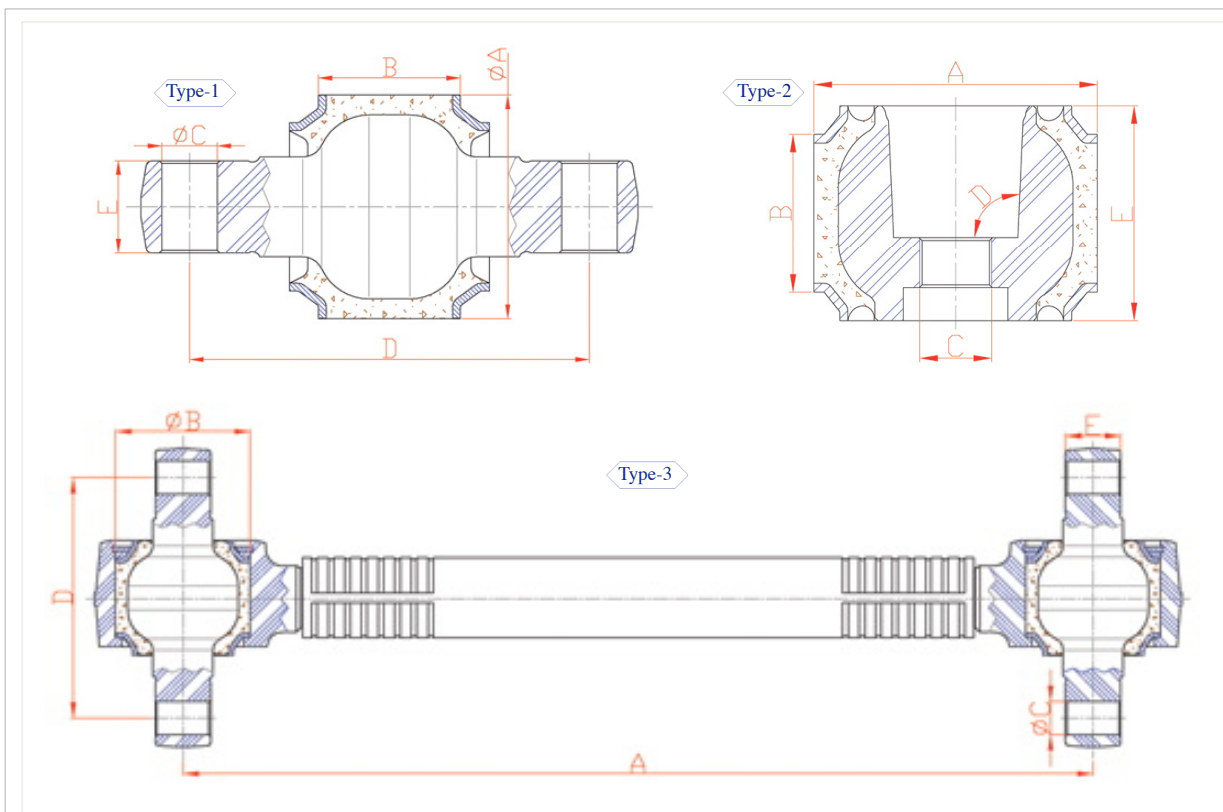

Sampa Nr.	O.E.M. Nr.	A	B	C	D	E	Repair Kit	Type
010.674	81.43220.6202	ø67	43	ø17	100	24	-	1
020.545	81.43220.6108 S	ø72	46.5	ø19	130	30	-	1
010.668	81.43230.6061	ø75	48	ø19	130	24	-	1
020.524	81.43230.6051	ø75	48	ø17	115	24	-	1
020.546	85.43220.6002	ø75	52	ø19	130	24	-	1
020.534	81.43230.6043 S	ø85	52.5	ø19	130	30	-	1
010.578	81.43220.6107	ø80	54	ø19	130	30	-	1
020.509	81.95302.0077	ø85	57.5	21.5/26	129	24	-	1
020.515	81.43270.6105	ø85	57.5	ø25	130	24	-	1
020.519	81.43220.6203	ø85	54	ø21	130	30	-	1
020.541	81.43220.6250	ø85	57.5	ø19	130	24	-	1
010.576	81.43270.6040	ø95	61	ø21	152	24	-	1
020.530	81.43220.6204	ø95	53	M24x2	2°52'	74	-	2
020.536	81.43270.6079	ø95	61	ø23	152	24	-	1
020.537	81.43315.0009	ø95	54	ø19	145	35	-	1
020.543	81.96401.0152	ø95	61	ø19	130	35	-	1
010.672	81.43270.6110	ø100	73	ø25	152	24	-	1
095.206	81.43230.6030	571	ø72	ø19	130	30	020.501	3
095.232	81.43220.6092	590	ø85	ø19	130	30	010.578	3
095.234	81.43220.6052	566	ø85	ø19	130	30	010.578	3
095.237	81.43220.6196	596	ø85	ø19	130	24	020.541	3



# V-Stay - Axle Control Arm

**MAN**



**Sampa Nr.**

**020.158**

**O.E.M. Nr.**

**81.96210.0447**

**Dimension**

ø94xø19/130

**Description**

Axle Rod Mounting

18.220/230/250/280/310/313/350/370/400/420/460  
22/24.330 - 24.310/350/400/460 - 28.270 - 322/352/402/422/462 FRH  
LION'S... - RH 353/403-SG 28.260/310 - L 18.220/260/280



**Sampa Nr.**

**010.674**

**O.E.M. Nr.**

**81.43220.6202**

**Dimension**

ø67xø17/100

**Description**

Rep. Kit for Axle Rod

L 2000



**Sampa Nr.**

**020.164**

**O.E.M. Nr.**

**81.96210.0448**

**Dimension**

M24x2/ø94x75

**Description**

Axle Rod Mounting

18.220/230/250/280/310/313/350/370/400/420/460  
... 322/352/402/422/462 FRH  
LION'S CLASSIC - LION'S COACH - LION'S STAR  
M 2000 - SG/SL/UEL



**Sampa Nr.**

**010.668**

**O.E.M. Nr.**

**81.43230.6061**

**Dimension**

ø75xø19/130

**Description**

Rep. Kit for Axle Rod

12/14/18.220  
24.310/350  
EL 202/222/262  
ND 202  
NG 232/235/242/252/262/272/312  
NGT 204  
NL 202/205/213/222/232/240/250/252/262/312  
NM 152  
NMT 222



**Sampa Nr.**

**020.545**

**O.E.M. Nr.**

**81.43220.6108 S**

**Dimension**

ø72xø19/130

**Description**

Rep. Kit for Axle Rod

16/17.170/192 F 90 ÖAF  
22/24.330-420 M 90



**Sampa Nr.**

**020.546**

**O.E.M. Nr.**

**85.43220.6002**

**Dimension**

ø75xø19/130

**Description**

Rep. Kit for Axle Rod

14.280 ND 313/363  
ECT18T/26T RH 403/463  
F 2000 STARLINER  
L 2000 TGA  
LION'S COACH TOURLINER  
LION'S REGIO TRENDLINER  
LION'S STAR UEL 313/353



**Sampa Nr.**

**020.524**

**O.E.M. Nr.**

**81.43230.6051  
(81.43230.6068)**

**Dimension**

ø75xø17/115

**Description**

Rep. Kit for Axle Rod

18.260/310/313... L 2000 - M 2000  
24.350/400 - F 2000 M 90  
F 90 ÖAF





<b>Sampa Nr.</b>	
<b>020.534</b>	
<b>O.E.M. Nr.</b>	
<b>81.43230.6043 S</b>	
<b>Dimension</b>	ø80xø19/130
<b>Description</b>	
Rep. Kit for Axle Rod	
12.170/192 14.170/192/220 15.220/240 16.220/240/280/281/290/291/321/331/360/361/370/372 17.220/240 19.281/291/321/331/361 22/24.330-420 22/24/25/26.220/240/281/291/321/331/361 F 90 M 90	

<b>Sampa Nr.</b>	
<b>010.578</b>	
<b>O.E.M. Nr.</b>	
<b>81.43220.6107 (81.43220.6055)</b>	
<b>Dimension</b>	ø85xø19/130
<b>Description</b>	
Rep. Kit for Axle Rod	
12/14.220 - 13.210/220/230 ... 322/352/402/422/462 FRH CENTROLINER LION'S CITY - LION'S CLASSIC - LION'S COACH - LION'S REGIO LION'S STAR - NEW FLYER - STARLINER - TOURLINER - TRENDLINER ND 202/313/363 - NG 232/ 235/242/243/252/262/263/272/312/313 NGT 204 NL 202/205/213/222/223/232/240/242/243/250/262/263/283/312/313 NM 223/283 - NMT 222 - NUE 263/313/353 - RH 353/403/463 SG 28.260/310 - SUE 223/253/263/313 TGA - UEL 313/353	

<b>Sampa Nr.</b>	
<b>020.509</b>	
<b>O.E.M. Nr.</b>	
<b>81.95302.0077</b>	
<b>Dimension</b>	ø85xø21.5/26x129
<b>Description</b>	
Rep. Kit for Axle Rod	
UEL 313/353 MAN 322/352/402/422/462 FRH RH 352/402/403/422	

<b>Sampa Nr.</b>	
<b>095.232</b>	
<b>O.E.M. Nr.</b>	
<b>81.43220.6092 (81.43220.6067) (81.43220.6068) (81.43220.6090)</b>	
<b>Dimension</b>	590
<b>Description</b>	
Tie Rod	
26T F 2000 F 90	
ÖAF TGA	

<b>Sampa Nr.</b>	
<b>020.515</b>	
<b>O.E.M. Nr.</b>	
<b>81.43270.6105</b>	
<b>Dimension</b>	ø85xø25/130
<b>Description</b>	
Rep. Kit for Axle Rod	
ECT18/26 F 2000 ÖAF TGA	

<b>Sampa Nr.</b>	
<b>095.234</b>	
<b>O.E.M. Nr.</b>	
<b>81.43220.6052 (81.43220.6010) (81.43220.6012) (81.43220.6013) (81.43220.6020) (81.43220.6035) (81.43220.6040) (81.43220.6041) (81.43220.6056)</b>	
<b>Dimension</b>	566
<b>Description</b>	
Tie Rod	
26.240/281/291/301/321/331/361/365 27.281/291/321/331/361 30.281/291/321/331/361 - 32.240/281/291/301/321/331/361/365 33.281/291/321/331/361 - 34.281/291/321/331/361	

O.E.M. Numbers are stated for comparison purposes only. It is not permitted to mention original numbers on invoices owners.











<b>Sampa Nr.</b>	
<b>020.537</b>	
<b>O.E.M. Nr.</b>	
<b>81.43315.0009</b>	
<b>Dimension</b>	ø95xø19/145
<b>Description</b>	Rep. Kit for Axle Rod
18.260/310/350/360/370/400/410/420/460 322/352/402/422/462 FRH LION'S COACH LION'S REGIO LION'S STAR RH 353/403/463 STARLINER TOURLINER TRENDLINER UEL 313/353	

<b>Sampa Nr.</b>	
<b>020.543</b>	
<b>O.E.M. Nr.</b>	
<b>81.96401.0152</b>	
<b>Dimension</b>	ø95xø19x130
<b>Description</b>	Rep. Kit for Axle Rod
F 2000 F 90 ÖAF TGA	

<b>Sampa Nr.</b>	
<b>010.672</b>	
<b>O.E.M. Nr.</b>	
<b>81.43270.6110</b>	
<b>Dimension</b>	ø100xø25/152
<b>Description</b>	Rep. Kit for Axle Rod
ÖAF TGA F 2000	

<b>Sampa Nr.</b>	
<b>020.535</b>	
<b>O.E.M. Nr.</b>	
<b>81.43250.6009</b>	
<b>Dimension</b>	ø20xø46x60
<b>Description</b>	Rep. Kit for Axle Rod
8/9.136/170 G 90 L 2000 TGL	

<b>Sampa Nr.</b>	
<b>020.501</b>	
<b>O.E.M. Nr.</b>	
<b>81.43220.6108 (81.43220.6132)</b>	
<b>Dimension</b>	ø72xø19/130
<b>Description</b>	Rep. Kit for Axle Rod
16.170/192 17.170/192 22/24.330-420 F 90 M 90 ÖAF	

<b>Sampa Nr.</b>	
<b>095.206</b>	
<b>O.E.M. Nr.</b>	
<b>81.43230.6030 (81.43220.6096) (81.43220.6097) (81.43220.6098) (81.43220.6129) (81.43230.6014)</b>	
<b>Dimension</b>	571
<b>Description</b>	Tie Rod
22/24.330-420 F 90 M 90	

# V-Stay - Axle Control Arm

**MAN**



**Sampa Nr.**  
**020.512**

**O.E.M. Nr.**  
**81.43270.6065**

**Dimension**  
M20x1.5/ø72x46

**Description**  
Rep. Kit for Axle Rod

14.280  
F 90  
L 2000  
M 2000  
M 90  
ÖAF

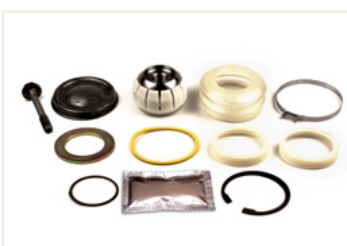

**Sampa Nr.**  
**020.503**

**O.E.M. Nr.**  
**81.95301.6132**  
**(81.43270.6080)**

**Dimension**  
M24x1.5/ø90x59

**Description**  
Rep. Kit for Axle Rod

12.170/192 - 14.170/192  
16.170/192/240/280/290/360/370/372 - 17.170/192  
18.310/313/350/360/370/400/410/420/460  
22/24.330-420 - 24.310/350/400/460  
F 2000 - F 90  
ÖAF



**Sampa Nr.**  
**020.502**

**O.E.M. Nr.**  
**81.43230.6043**

**Dimension**  
ø80xø19/130

**Description**  
Rep. Kit for Axle Rod

12.170/192 - 14.170/192 - 14.240  
15.220/240 - 16.220/240/280/281/290/291/321/331/360/361/370/372  
17.220/240 - 19.281/291/321/331/361  
22/24.330-420 - 22/24/25/26.220/240/281/291/321/331/361  
F 90 - M 90



**Sampa Nr.**  
**020.504**

**O.E.M. Nr.**  
**81.95301.6133**

**Dimension**  
ø90xø23/152

**Description**  
Rep. Kit for Axle Rod

12.170/192  
14.170/192  
16.170/192  
17.170/192  
22/24.330-420



**Sampa Nr.**  
**020.539**

**O.E.M. Nr.**  
**81.43270.6047**

**Dimension**  
M24x1.5/ø90x60

**Description**  
Rep. Kit for Axle Rod

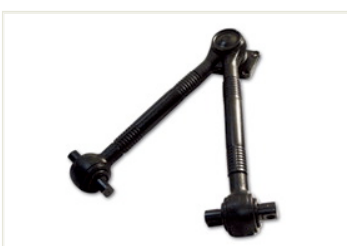

**Sampa Nr.**  
**095.208**

**O.E.M. Nr.**  
**81.43270.6030**  
**(81.43270.6034)**  
**(81.43270.6054)**  
**(81.43270.6055)**  
**(81.43270.6078)**  
**(81.43270.9054)**  
**(81.43270.9078)**

**Dimension**  
621

**Description**  
V-Arm

14.220  
15.220/240  
16/17.220/240/281/291/321/331/361  
19.281/291/321/331/361  
22/24/25/26.220/240/281/291/321/331/361  
F 2000  
F 90

V-Stay - Axle Control Arm



<b>Sampa Nr.</b>	
<b>020.503</b>	
<b>O.E.M. Nr.</b>	
<b>81.95301.6132 (81.43270.6080)</b>	
<b>Dimension</b>	M24x1.5/ø90x59
<b>Description</b>	Rep. Kit for Axle Rod
12.170/192 14.170/192 16.170/192/240/280/290/360/370/372 17.170/192 18.310/313/350/360/370/400/410/420/460 22/24.330-420 24.310/350/400/460 F 2000 F 90 ÖAF	

<b>Sampa Nr.</b>	
<b>020.515</b>	
<b>O.E.M. Nr.</b>	
<b>81.43270.6105</b>	
<b>Dimension</b>	ø85xø25/130
<b>Description</b>	Rep. Kit for Axle Rod
ECT18/26 F 2000 ÖAF TGA	

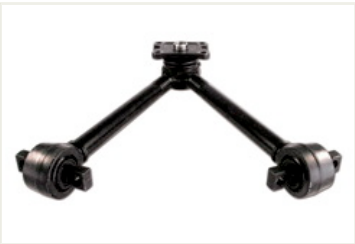
<b>Sampa Nr.</b>	
<b>095.233</b>	
<b>O.E.M. Nr.</b>	
<b>81.43270.6096</b>	
<b>Dimension</b>	627
<b>Description</b>	V-Arm
ECT 26T TGA	

<b>Sampa Nr.</b>	
<b>O.E.M. Nr.</b>	
<b>Dimension</b>	
<b>Description</b>	

<b>Sampa Nr.</b>	
<b>O.E.M. Nr.</b>	
<b>Dimension</b>	
<b>Description</b>	

<b>Sampa Nr.</b>	
<b>O.E.M. Nr.</b>	
<b>Dimension</b>	
<b>Description</b>	

# Engine - Flywheel

MAN



Sampa Nr.

**100.055**

O.E.M. Nr.

**51.02130.0013**  
(51.93020.0236)

Dimension

ø115xø120x21

Description

Intermediate Ring, (No Hardening)

D2066	D2842	G2866
D2530	D2865	G2876
D2565	D2866	GS UEH
D2566	D2876	270/290/320/370
D2676	E2866	
D2840	E2876	



Sampa Nr.

**100.055/1**

O.E.M. Nr.

**51.02130.0013 S**  
(51.93020.0236 S)

Dimension

ø115xø120x21

Description

Intermediate Ring, (Surface Hardened)

D2066	D2842	G2866
D2530	D2865	G2876
D2565	D2866	GS UEH
D2566	D2876	270/290/320/370
D2676	E2866	
D2840	E2876	

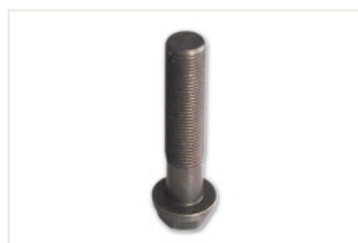

Sampa Nr.

**020.062**

O.E.M. Nr.

**51.90020.0298**  
(51.90020.0349)  
(51.90030.0025)

Dimension

M16x1.5/72

Description

Flywheel Bolt

D2066	D2842	E2876
D2565	D2865	G2866
D2566	D2866	G2876
D2676	D2876	
D2840	E2866	

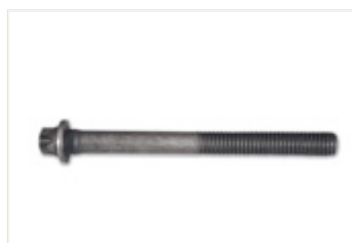

Sampa Nr.

**020.063**

O.E.M. Nr.

**51.90020.0356**  
(51.90020.0284)  
(51.90020.0357)  
(51.90020.0381)  
(51.90020.0275)

Dimension

Te14x2/140

Description

Cylinder Head Bolt

D0824
D0826
G0826



Sampa Nr.

**020.065**

O.E.M. Nr.

**51.90490.0023**  
(51.90020.0269)  
(51.90020.0235)

Dimension

M15x2/143

Description

Cylinder Head Bolt

D2530	D2866
D2565	D2876
D2566	E2866
D2840	E2876
D2842	G2866
D2865	G2876



Sampa Nr.

**020.066**

O.E.M. Nr.

**51.90490.0024**  
(51.90020.0270)  
(51.90020.0236)

Dimension

M15x2/110

Description

Cylinder Head Bolt

D2530	D2866
D2565	D2876
D2566	E2866
D2840	E2876
D2842	G2866
D2865	G2876





<b>Sampa Nr.</b>	
<b>020.306</b>	
<b>O.E.M. Nr.</b>	
<b>81.96020.0341</b>	
<b>(81.96020.0373)</b>	
<b>(81.96020.0385)</b>	
<b>(81.96020.0408)</b>	
<b>(81.96020.0418)</b>	
<b>Dimension</b>	ø107x85
<b>Description</b>	Engine Mounting
<p>18.220/260/290/310/313/350/360/370/400/410/420/460                  22/24.330-420 - 24.310/350/400/460 - 26T                  322/352/402/422/462 FRH                  D2840 - F 2000 - F 90 - M 2000                  LION'S COACH                  ÖAF                  RH 353/403/463                  TGA</p>	

<b>Sampa Nr.</b>		
<b>020.309</b>		
<b>O.E.M. Nr.</b>		
<b>81.96020.0205</b>		
<b>(81.96020.0235)</b>		
<b>Dimension</b>		ø96x84
<b>Description</b>		Engine Mounting
<p>10/11.150/180/190/220/230 - 12.170/192 - 14.170/192                  16.170/192 - 17.170/192                  8/9.136/170                  CENTROLINER - GOEPEL-AUFBAU - LION'S CITY                  D2866 - D2876 - G 90 - L 2000 - M 90                  NL 223/263/313                  ÖAF</p>		

<b>Sampa Nr.</b>	
<b>020.310</b>	
<b>O.E.M. Nr.</b>	
<b>81.96020.0202</b>	
<b>(81.96020.0239)</b>	
<b>(81.96210.0509)</b>	
<b>Dimension</b>	
<b>Description</b>	Engine Mounting
<p>10/11.150/180/190/220/230 - 12.170/192/220                  13.210/220/230 - 14.170/192/220                  16/17.170/192 - 266M-STAR                  6/8.90 F/FR - 8/9.136/170                  F 2000 - F 90 - G 90 - L 2000 - M 2000 - M 90                  ÖAF                  SG 292</p>	

<b>Sampa Nr.</b>		
<b>020.312</b>		
<b>O.E.M. Nr.</b>		
<b>81.96020.0382</b>		
<b>(88.96210.0004)</b>		
<b>Dimension</b>		ø96x84
<b>Description</b>		Engine Mounting
<p>10/11.150/180/190/220/230 - 12.220                  13.210/220/230 - 14.280 - 18.220/230/250/280                  266M-STAR - D0836 - F 90 - L 2000 - M 2000 - M 90                  LION'S CITY - LION'S CLASSIC                  ÖAF                  SL 18.220/260/280                  SUE 223/253/263/313</p>		

<b>Sampa Nr.</b>		
<b>020.313</b>		
<b>O.E.M. Nr.</b>		
<b>81.96020.0403</b>		
<b>(81.96020.0391)</b>		
<b>Dimension</b>		ø96x84
<b>Description</b>		Engine Mounting
<p>12.220 - 18.220/290/370 - 26T                  CENTROLINER                  F 2000 - F 90 - L 2000                  LION'S CITY                  M 2000                  NG 263/313 - NL 223/263/313                  ÖAF</p>		

<b>Sampa Nr.</b>		
<b>020.314</b>		
<b>O.E.M. Nr.</b>		
<b>81.96020.0386</b>		
<b>Dimension</b>		ø88x72
<b>Description</b>		Engine Mounting
<p>322/352/402/422/462 FRH                  LION'S COACH                  RH 353/403/463</p>		

# Engine - Flywheel / Propeller Shaft

MAN



Sampa Nr.

**020.315**

O.E.M. Nr.

**81.96020.0384**

Dimension

ø107x85

Description

Engine Mounting

322/352/402/422/462

FRH

12.220

CENTROLINER

LION'S CITY

LION'S COACH

NG 263/313

NL 223/263/313

NM 223/283

RH 353/403/463



Sampa Nr.

**020.157**

O.E.M. Nr.

**81.39410.6017**

**(81.39410.6013)**

**(81.99804.3084)**

Dimension

ø65

Description

Propeller Shaft Bearing

16.170/192/200/240/280/281/290/291/321/331/360/361/372

17.170/192

19.240/281/291/321/331/361

22.220/240/281/291/321/331/361

24.220/240/281/291/321/331/361

25.220/240/281/291/321/331/361

26.220/240/281/291/301/321/331/361/365

30.281/291/321/331/361

32.240/281/291/321/301/331/361/365

33.281/291/321/331/361

34.281/291/321/331/361

SG 280/292 - SL 200

SR 240/280

SUE 240/280



Sampa Nr.

**020.318**

O.E.M. Nr.

**81.96020.0402**

Dimension

ø126x105

Description

Engine Mounting

F 2000

ÖAF



Sampa Nr.

**020.181**

O.E.M. Nr.

**81.39410.6018**

**(81.39410.6016)**

Dimension

ø100

Description

Propeller Shaft Bearing

L 2000

M 2000



Sampa Nr.

**020.319**

O.E.M. Nr.

**81.96020.0340**

Dimension

ø88x72

Description

Engine Mounting

18.220/260/290/310/313/350/360/370/400/410/420/460

22/24.330-420

24.310/350/400/460

F 2000

F 90

NM 223/283

ÖAF



Sampa Nr.

**020.213**

O.E.M. Nr.

**81.39410.6023**

**(81.39410.6031)**

Dimension

ø85

Description

Propeller Shaft Bearing

12.220

18.220/290/370

26T

CENTROLINER

F 2000

F 90

L 2000

LION'S CITY

M 2000

NG 263/313

NL 223/263/313

ÖAF

## Sampa Nr.

**020.076**

## O.E.M. Nr.

**81.95301.6202**  
**(81.95301.6227)**  
**(81.95301.6200)**



## Dimension

M10x1.25/M14x1.5

## Description

Ball Joint

18.220/230/250/260/280/290/310 - 18.310/313/350/370/400/420/460  
 22/24.330-420 - 24.310/350/400/460  
 322/352/402/422/462 FRH  
 8/9.136/170  
 EL 202/222/262  
 F 2000 - F 90 - G 90 - L 2000  
 LION'S CITY - LION'S CLASSIC  
 M 90 - M2000 L - M2000 M  
 ÖAF  
 RH 352/402/422 - RH 353/403 F  
 SL 18.220/260/280 - SUE 223/242/253/263/313  
 TGL - TGM  
 UEL 242/272/292/312/ 313/322/353

## Sampa Nr.

**100.007**

## O.E.M. Nr.

**81.95301.0045**

## Dimension

M10x1/M14x1.5

## Description

Ball Joint

16.240/280/290/360/372 GS UEH 270/290/320/370  
 12.170/192 8.125 STAR  
 14.170/192 12.155 STAR  
 16/17.170/192 18.220/230/250  
 16.170/192 18.230/250  
 16/19.281/291/321/331/361 L 2000  
 26/32/33/34.281/291/321/331/361 M 2000  
 26/27/32/33/34.281/291/321/331/361 L 2000  
 30/32/33/34.281/291/321/331/361 MAN 292/332/362  
 16/17.220/240/19.240  
 22/24/25/26.220/240  
 14/15.220/15.240  
 16/17.220/240  
 26/32.365  
 SUE 240/280  
 SL 202

## Sampa Nr.

**100.008**

## O.E.M. Nr.

**81.95301.6171**  
**(81.95301.6063)**  
**(81.95301.6131)**  
**(81.95301.6174)**



## Dimension

M10x1.5/M12x1.75L

## Description

Ball Joint, Left

18.220/230/250 TGM  
 18.220/290/370  
 LION'S CLASSIC  
 SL 18.220/260/280

## Sampa Nr.

**020.104**

## O.E.M. Nr.

**81.96210.0089**

## Dimension

M16/ø100x74

## Description

Gearbox Mounting

12.220  
 14.280  
 14/15.220  
 15.240  
 16.240/280/290/360/370/372  
 16/17.220/240/19.240  
 16/19.281/291/321/331/361  
 18.220/280/310/313/310/350/360/370/400/410/420/460  
 19.240 H  
 22/24.330-420  
 22/24/25/26.220/240/281/291/321/331/361  
 24.350/400/460  
 26/32.240/281/291/301/321/331/361/365  
 27/33/34.281/291/321/331/361  
 F 2000  
 F 90  
 ÖAF

## Sampa Nr.

**100.009**

## O.E.M. Nr.

**81.95301.6170**  
**(81.95301.6064)**  
**(81.95301.6130)**  
**(81.95301.6173)**



## Dimension

M10x1.5/M12x1.75R

## Description

Ball Joint, Right

F 2000 M 2000  
 F 90 M 90  
 G 90 TGM  
 L 2000 TGL

MAN

# Cooling System

MAN

	<p><b>Sampa Nr.</b> <b>020.082</b></p> <p><b>O.E.M. Nr.</b> <b>81.96210.0248</b> <b>(81.96210.0243)</b></p>		<p><b>Sampa Nr.</b> <b>020.088</b></p> <p><b>O.E.M. Nr.</b> <b>81.96020.0056</b> <b>(81.96020.7000)</b> <b>(51.96210.0002)</b></p>
<p><b>Dimension</b> ø13xø68.5x20</p>		<p><b>Dimension</b> M8/ø40x30</p>	
<p><b>Description</b> Rubber Mounting for Radiator</p>		<p><b>Description</b> Rubber Mounting for Radiator</p>	
<p>10/11.150/180/190/220/230 16.200/240/280/290/360/370/372 18.220/230/250/260/280/310/313/350/370/400/420 - 19.240 22/24.330-420 - 26/32.281/301/321 - 28.270 322/352/402/422/462 FRH EL 202/222/262 F 2000 - F 90 - TGA LION'S CITY - LION'S CLASSIC ND202 - NG 232/242/252/262/272/312 NL 202/205/213/222/232/250/252/262/310/312 - NM152</p>			
	<p><b>Sampa Nr.</b> <b>020.089</b></p> <p><b>O.E.M. Nr.</b> <b>81.96210.0119</b></p>		<p><b>Sampa Nr.</b> <b>020.092</b></p> <p><b>O.E.M. Nr.</b> <b>81.96210.0240</b> <b>(81.43706.0006)</b></p>
<p><b>Dimension</b> M10/ø50x30</p>		<p><b>Dimension</b> ø22xø56x21.5</p>	
<p><b>Description</b> Rubber Mounting for Radiator</p>		<p><b>Description</b> Rubber Mounting for Radiator</p>	
		<p>10/11.150/180/190/220/230 12/14.170/192 16/17.170/192 6/8.90 8.136 8/9.136/170</p> <p>F 2000 G 90 M 2000 M M 90 ÖAF</p>	
	<p><b>Sampa Nr.</b> <b>020.094</b></p> <p><b>O.E.M. Nr.</b> <b>81.96210.0100</b></p>		<p><b>Sampa Nr.</b> <b>020.187</b></p> <p><b>O.E.M. Nr.</b> <b>81.96210.0426</b></p>
<p><b>Dimension</b> M10/ø50x45</p>		<p><b>Dimension</b> ø12xø38.5x44</p>	
<p><b>Description</b> Rubber Mounting for Radiator</p>		<p><b>Description</b> Rubber Mounting for Radiator</p>	
<p>18.220/230/250/260/280/310/313/350/370/400/420/460 22/24.330-420 - 24.350/400/460 L 2000 LION'S CITY M 90 RH 352/402/422 SL 18.220/260/280 - SUE 223/253/263/313</p>		<p>10/11.150/180/190/220/230 - 12.220 13.210/220/230 - 14.220/280 - 18.220 18.310/313/350/370/400/420/460 22/24.330-420 - 24.310/350/400/460 - 26T - 28.270 F 2000 - F 90 LION'S CLASSIC - LION'S COACH - LION'S REGIO - TRENDLINER M 2000 - NM 223/283 ÖAF SG 28.260/310 - SUE 223/253/263/313</p>	





<b>Sampa Nr.</b>	
<b>020.060</b>	
<b>O.E.M. Nr.</b>	
<b>51.90001.0167</b>	
<b>(51.90001.0122)</b> <b>(51.90430.0046)</b>	
<b>Dimension</b>	M10x1.5/75
<b>Description</b>	Exhaust Manifold Bolt
D2566 D2842 D2866	

<b>Sampa Nr.</b>		
<b>020.061</b>		
<b>O.E.M. Nr.</b>		
<b>51.90001.0169</b>		
<b>(51.90430.0044)</b>		
<b>Dimension</b>	M10x1.5/55	
<b>Description</b>	Exhaust Manifold Bolt	
D0226 D0824 D0826	D2530 D2565 D2566	D2866 G0826

<b>Sampa Nr.</b>		
<b>020.067</b>		
<b>O.E.M. Nr.</b>		
<b>51.90490.0029</b>		
<b>(51.90001.0168)</b> <b>(51.90490.0033)</b>		
<b>Dimension</b>	M10x1.5/50	
<b>Description</b>	Exhaust Manifold Bolt	
D0824 D0826 D0834	D0836 D2840 D2866	

<b>Sampa Nr.</b>			
<b>020.068</b>			
<b>O.E.M. Nr.</b>			
<b>51.90490.0030</b>			
<b>(51.90001.0156)</b> <b>(51.90001.0166)</b>			
<b>Dimension</b>	M10x1.5/55		
<b>Description</b>	Exhaust Manifold Bolt		
D0824 D0826 D0834 D0836	D2565 D2566 D2840 D2842	D2866 E2866 F 2000 G2866	ÖAF

<b>Sampa Nr.</b>	
<b>020.085</b>	
<b>O.E.M. Nr.</b>	
<b>81.96210.0101</b>	
<b>Dimension</b>	M10/ø50x40
<b>Description</b>	Rubber Mounting for Exhaust
<p>12.220 - 14.220/280 - 15.220/15.240 ...                      30/32/33/34.281/291/321/331/361 - 322/352/402/422/462 FRH                      CENTROLINER                      F 2000 - F 90                      LION'S CITY - LION'S CLASSIC - LION'S COACH - LION'S STAR                      MAN 292/332/362 HF                      ND 313/363 - NG 232/235/252/262/263/272/312/313 - NL                      202/213/205/222/223/232/240/242/243/250/252/262/283/310/312/313                      NL/NUE 263/313/353 - NM 223/283                      ÖAF - TGA                      RH 353/403/463                      SG 242/292/322 - SG 28.260/310                      SL 18.220/260/280 - SL 200/202 - SR 240/280                      STARLINER - TOURLINER                      SUE 223/240/242/280/290/253/263/313                      UEL 242/272/292/312/313/322/353</p>	

<b>Sampa Nr.</b>	
<b>020.090</b>	
<b>O.E.M. Nr.</b>	
<b>81.96210.0052</b>	
<b>(81.96210.0301)</b>	
<b>Dimension</b>	M8/ø40x30
<b>Description</b>	Rubber Mounting for Exhaust
<p>10/11.150/180/190/220/230 ... - 322/352/402/422/462 FRH                      8/9.136/170                      F 2000 - F 90 - G 90 - L 2000                      LION'S CITY - CENTROLINER                      M 90 - M2000 L - M2000 M                      MAN 292                      ND 202/313/363 FR - NG 232/242/252/262/263/272/312/313                      NL 202/213/222/223/ 232 /250/252/262/ 263/310/312/313/353                      NM 152/223/283 - NUE 263/313/353                      ÖAF                      RH 352/353/402/403/422                      SD 202 F - SG 242/280/292/322 - SL 200/202                      SR 240/280 - SUE 240/242/280/290                      TGA                      UEL 242/272/292/312/322</p>	

# Exhaust / Shock Absorber

**MAN**

	<i>Sampa Nr.</i>
	<b>020.096</b>
	<i>O.E.M. Nr.</i>
	<b>81.96210.0153 (81.96210.0127)</b>
<i>Dimension</i>	
M10/ø50x30	
<i>Description</i>	
Rubber Mounting for Exhaust	
<p>16.220/240/280/281/290/291/321/331/360/361/370 /372          17.220/240          18.220/290/370 FOC/R-SKD-RSA          19.240/281/291/321/331/361          22/24.330-420          22/24/25/26.291/331/361          26/32.240/281/301/321          28.270          30/32/33/34.281/291/321/331/361          CENTROLINER          F 2000          F 90          L 2000          LION'S CITY          M 2000 M          NG 263/313 F          NL 223/242 /243/283          NL/NUE 263/313/353          ÖAF          RH 403/463          SD 202 F          SG 28.260/310          SUE 223/242/253/263/313          TGA</p>	

	<i>Sampa Nr.</i>
	<b>020.138</b>
	<i>O.E.M. Nr.</i>
	<b>81.61140.0016</b>
<i>Dimension</i>	
685 mm	
<i>Description</i>	
Gas Spring	
<p>ECT18/26          TGA</p>	

	<i>Sampa Nr.</i>
	<b>020.139</b>
	<i>O.E.M. Nr.</i>
	<b>81.74821.0095</b>
<i>Dimension</i>	
720 mm/220 N	
<i>Description</i>	
Gas Spring	
<p>18.220/290/370          F 2000          F 90          M 2000          M 90          ÖAF</p>	

	<i>Sampa Nr.</i>
	<b>020.097</b>
	<i>O.E.M. Nr.</i>
	<b>81.96210.0130</b>
<i>Dimension</i>	
M10/ø50x45	
<i>Description</i>	
Rubber Mounting for Exhaust	
<p>19240          26/32.240          F 2000</p>	

	<i>Sampa Nr.</i>
	<b>020.140</b>
	<i>O.E.M. Nr.</i>
	<b>81.61130.6500</b>
<i>Dimension</i>	
350 mm/220 N	
<i>Description</i>	
Gas Spring	





<i>Sampa Nr.</i>	
<b>020.051</b>	
<i>O.E.M. Nr.</i>	
<b>06.02815.8812</b>	
<b>(06.02814.2812)</b>	
<b>(06.02813.4812)</b>	
<b>(06.02792.5010)</b>	
<b>(06.02791.5010)</b>	
<i>Dimension</i>	M12x1.5/35
<i>Description</i>	Tensilock Screw

<i>Sampa Nr.</i>	
<b>020.052</b>	
<i>O.E.M. Nr.</i>	
<b>06.02815.8911</b>	
<b>(06.02792.5109)</b>	
<b>(06.02814.2911)</b>	
<b>(06.02813.4911)</b>	
<b>(06.02816.0911)</b>	
<i>Dimension</i>	M14x1.5/30
<i>Description</i>	Tensilock Screw

<i>Sampa Nr.</i>	
<b>020.053</b>	
<i>O.E.M. Nr.</i>	
<b>06.02815.8912</b>	
<b>(06.02814.2912)</b>	
<b>(06.02813.4912)</b>	
<b>(06.02792.5110)</b>	
<b>(06.02816.0912)</b>	
<b>(06.02791.5110)</b>	
<i>Dimension</i>	M14x1.5/35
<i>Description</i>	Tensilock Screw

<i>Sampa Nr.</i>	
<b>020.054</b>	
<i>O.E.M. Nr.</i>	
<b>06.02815.8914</b>	
<b>(06.02792.5112)</b>	
<b>(06.02813.4914)</b>	
<b>(06.02814.2914)</b>	
<b>(06.02819.0006)</b>	
<i>Dimension</i>	M14x1.5/45
<i>Description</i>	Tensilock Screw

<i>Sampa Nr.</i>	
<b>020.055</b>	
<i>O.E.M. Nr.</i>	
<b>06.02815.8916</b>	
<b>(06.02814.2916)</b>	
<b>(06.02813.4916)</b>	
<b>(06.02202.0609)</b>	
<i>Dimension</i>	M14x1.5/55
<i>Description</i>	Tensilock Screw

<i>Sampa Nr.</i>	
<b>020.056</b>	
<i>O.E.M. Nr.</i>	
<b>06.02815.8917</b>	
<b>(06.02814.2917)</b>	
<b>(06.02813.4917)</b>	
<i>Dimension</i>	M14x1.5/60
<i>Description</i>	Tensilock Screw

# Chassis - Body

MAN

 <p><b>Dimension</b> M14x1.5/50</p> <p><b>Description</b> Tensilock Screw</p>	<p><b>Sampa Nr.</b> <b>020.146</b></p> <p><b>O.E.M. Nr.</b> 06.02815.8915 (06.02813.4915) (06.02814.2915)</p>	 <p><b>Dimension</b> M14x1.5/40</p> <p><b>Description</b> Tensilock Screw</p>	<p><b>Sampa Nr.</b> <b>020.147</b></p> <p><b>O.E.M. Nr.</b> 06.02815.8913 (06.02792.5111) (06.02814.2913) (06.02813.4913)</p>
 <p><b>Dimension</b> M14x1.5/70</p> <p><b>Description</b> Tensilock Screw</p>	<p><b>Sampa Nr.</b> <b>020.152</b></p> <p><b>O.E.M. Nr.</b> 06.02813.4919 (06.02814.2919) (06.02815.8919)</p>	 <p><b>Dimension</b> M14x1.5/14</p> <p><b>Description</b> Flat Collar Nut</p>	<p><b>Sampa Nr.</b> <b>020.151</b></p> <p><b>O.E.M. Nr.</b> 06.11251.2105 (06.11251.8105) (06.11251.2005)</p>
 <p><b>Dimension</b> M16x1.5/40</p> <p><b>Description</b> Tensilock Screw</p>	<p><b>Sampa Nr.</b> <b>020.057</b></p> <p><b>O.E.M. Nr.</b> 06.02815.9013 (06.02791.5211) (06.02813.5013) (06.02792.5211) (06.02814.3013) (06.02816.1013)</p>	 <p><b>Dimension</b> M16x1.5/50</p> <p><b>Description</b> Tensilock Screw</p>	<p><b>Sampa Nr.</b> <b>020.058</b></p> <p><b>O.E.M. Nr.</b> 06.02815.9015 (06.02792.5213) (06.02814.3015)</p>

## Chassis - Body - Filter - Air Suspension

MAN

Sampa Nr.

**020.059**

O.E.M. Nr.

**06.02815.9017**  
(06.02814.3017)



Dimension

M16x1.5/60

Description

Tensilock Screw

Sampa Nr.

**020.153**

O.E.M. Nr.

**06.02815.9022**  
(06.02814.3022)  
(06.02813.5022)



Dimension

M16x1.5/85

Description

Tensilock Screw

Sampa Nr.

**020.150**

O.E.M. Nr.

**06.11251.8108**  
(06.11251.2108)



Dimension

M16x1.5/16

Description

Flat Collar Nut

Sampa Nr.

**020.091**

O.E.M. Nr.

**81.96210.0289**  
(83.96210.0508)



Dimension

M8/ø30x20

Description

Air Filter Mounting

18.220/230/250 - EL 202/222/262 - F 90  
LION'S CITY - LION'S CLASSIC  
M 2000 - NL 202/213/222/250/262/312 - ÖAF  
SL 200 - SR 240/280-12 M RUE 240/280 - SUE 240/280 - TGA

Sampa Nr.

**020.075**

O.E.M. Nr.

**81.95301.6144**  
(06.36090.0605)  
(81.95301.7004)



Dimension

M8x1.25/M8x1.25R

Description

Ball Joint, Right

10/11.150/180/190/220/230 - 12.170/192 - 13.210/220/230  
14.170/192 - 14/15.220/15.240 - 16.240/280/290/360/370/372  
16/17.170/192/220/240/19.240 - 16/19.281/291/321/331/361  
18.220/290/370 - 22/24.330-420  
22/24/25/26.220/240/281/291/321/331/361 - 24.400/460  
26/27/30/32/33/34.281/291/321/331/361 - 26/32.365 - 26T  
6/8.90 - 8/9.136/170  
CENTROLINER - LION'S CITY  
D2840 - ECT26  
F 2000 - F 90 - G 90 - L 2000 - M 90 - TGA - ÖAF  
GS UEH 270/290/320/370  
MAN 292/322/332/352/362/402/422/462  
NG 242/272/312 - NGT 204 - NL/NUE 263/313/353  
NL202/213/222/250/262/312  
SG 242/280/282/292/322 - SL 200/202 - SR 240/280 - SUE 240/242/280  
UEL 242/272/292/312/322

Sampa Nr.

**020.077**

O.E.M. Nr.

**81.95301.6204**



Dimension

M8x1.25/M8x1.25L

Description

Ball Joint, Left

10/11.150/180/190/220/230  
13.210/220/230  
F 90  
G 90  
L 2000  
M 90  
ÖAF  
SL202  
SUE 240/280/290