

Spare Parts for European Trucks & Trailers



3

VOLVO

"technology, reliability & quality..."



www.sampakw.com

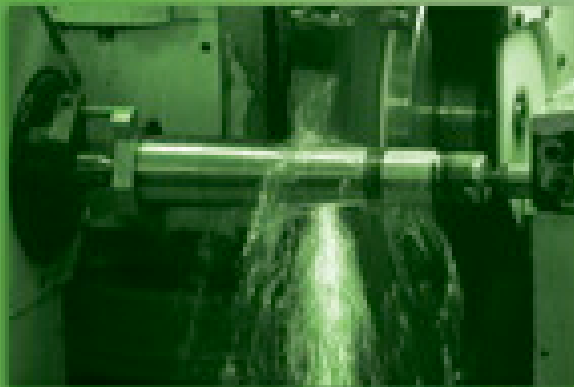
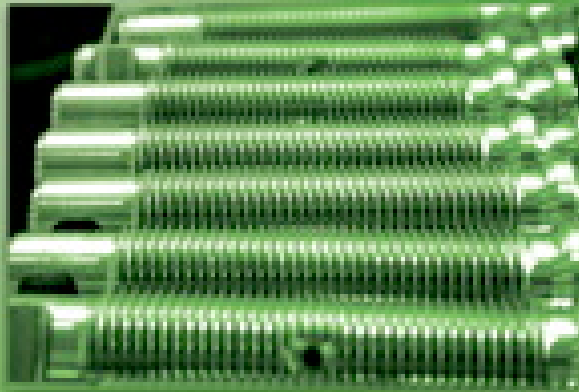

"technology. reliability & quality..."

www.sampalkw.com

Sampa Nr.
030.253

O.E.M. Nr.
2053 3294



Dimension
ø20.5xø52.5x110

Description
Rubber Bushing for Spring

FH 12
FH 16
FM 12
FM 9

Sampa Nr.
030.186

O.E.M. Nr.
1696 042



Dimension
ø24xø59x107

Description
Rubber Bushing for Spring

F 10
F 12

Sampa Nr.
030.237

O.E.M. Nr.
3111 274



Dimension
ø13xø60.5x73

Description
Rubber Bushing for Spring

"B 10 B, B 10 BLE"	B 7 R
B 10 L	OLYMPIAN MKII
B 12 B	SUPEROLYMPIAN
B 6 BLE	
B 7 L	
B 7 L DD	

Sampa Nr.
030.136

O.E.M. Nr.
1624 486



Dimension
ø26xø55x111.5

Description
Rubber Bushing for Spring

FH 12	FM 10 BR
FH 12 BR	FM 12
FH 12 J	FM 12 BR
FH 16	FM 7
FH 16 J	FM 9
FL 6	NH 12
FM 10	NH 12 BR

Sampa Nr.
030.239

O.E.M. Nr.
7030 8561
(3112 049)



Dimension
ø16xø70x82.5

Description
Rubber Bushing for Spring

"B 10 B, B 10 BLE"
B 10 L
B 12 B
B 6 BLE
B 7 L
B 7L DD
B 7 R
SUPEROLYMPIAN

Sampa Nr.
030.556

O.E.M. Nr.
1624 486 S



Dimension
ø26xø55x111.5

Description
Rep. Kit Spring Bolt Assembly

FH 12	FM 10 BR
FH 12 BR	FM 12
FH 12 J	FM 7
FH 16	NH 12
FH 16 J	NH 12 BR
FM 10	

Spring Suspension

VOLVO



Sampa Nr.

020.030

O.E.M. Nr.

6879 332

Dimension

ø16xø50x95

Description

Rubber Bushing for Spring

FL 6

FL 608-615

B6



Sampa Nr.

030.537

O.E.M. Nr.

**955 377 S
(963 324 S)**

Dimension

M16x2/130

Description

Rep. Kit Spring Bolt Assembly

B 6	FL 12	N 12
F 10	FL6	NH 12
F 12	FL7	NH 12 BR
F 16	FLC	NL 10 BR
F 16	FM 10	NL 10 S
FH 12	FM 12	NL 12 BR
FH 16	"FM 12 / FM9, FAA11"	NL 12 S
FL 608-615	FM 7	
FL 616-619	FS 7	
FL 10	N 10	



Sampa Nr.

030.544

O.E.M. Nr.

6879 332 S

Dimension

ø16xø50x95

Description

Rep. Kit Spring Bolt Assembly

B 6

FL 6

FL 608-615



Sampa Nr.

030.173

O.E.M. Nr.

3027 227

Dimension

ø20xø55.5x120

Description

Rubber Bushing for Spring

FE 6

FL 616-619



Sampa Nr.

030.554

O.E.M. Nr.

6879 332 S1

Dimension

ø16xø50x95

Description

Rep. Kit Spring Bolt Assembly

FE 6

FL 608-615

FL 616-619

FS 7

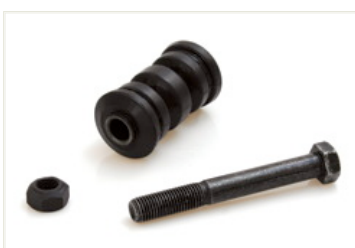

Sampa Nr.

030.555

O.E.M. Nr.

3027 227S

Dimension

ø20xø55.5x120

Description

Rep. Kit Spring Bolt Assembly

FL 616-619

Sampa Nr.		
030.263		
O.E.M. Nr. 2042 9274		
Dimension		
Description Cradle		
FL 6	FH 16	
FH 12	NH 12	
FM 12		
FM 9		

Sampa Nr.			
030.234			
O.E.M. Nr. 1590 885			
Dimension		ø130xø135x80	
Description Bogie Suspension Bushing			
F 10	FH 16	FL 7	FM 9
F 12	FL 10	FM 10	N 10
F 16	FL 12	FM 12	NL 10 S
FH 12	FL 6	FM 7	NL 12 S

Sampa Nr.		
030.264		
O.E.M. Nr. 2044 2252		
Dimension		ø81/ø104xø154/ø173x71
Description Bogie Suspension Bearing		
FL 6	NH 12	
FH 12		
FM 12		
FM 9		
FH 16		

Sampa Nr.			
030.236			
O.E.M. Nr. 1593 431 (1590 886)			
Dimension		ø136xø175x2.5	
Description Thrust Washer			
F 10	FH 16 J	FM 10	NH 12
F 12	FL 10	FM 12	NH 12 BR
F 16	FL 12	FM 7	NH 12
FH 12	FL 6	FM 9	NL 10 S
FH 16	FL 7	N 10	

Sampa Nr.		
030.265		
O.E.M. Nr. 2046 6804		
Dimension		ø25xø107x74
Description Bogie Suspension Bearing		
FL 6		
FH 12		
FM 12		
FM 9		
FH 16		
NH 12		

Sampa Nr.		
030.195		
O.E.M. Nr. 1502 292		
Dimension		ø9x204.5/ø229x37
Description Cap		
F 10	FL 7	NH 12
F 12	FM 10	NL 10 AUS
F 16	FM 10 BR	NL 10 BR
FH 12 BR	FM 12	NL 10 S
FH 12	FM 12 BR	NL 12 AUS
FH 16	FM 7	NL 12 BR
FH 16 J	FM 9	NL 12 S
FL 10	N 10	
FL 12	NH 12	
FL 6	NH 12 BR	

Spring Suspension

VOLVO



Sampa Nr.

030.009

O.E.M. Nr.

1581 543

Dimension

ø130xø134x81.5

Description

Plastic Bearing

F 10	FL 10	FM 7	NL 12 AUS
F 12	FL 12	FM 9	NL 12 BR
F 16	FL 7	N 10 USA	NL 10 BR
FH 12	FM 10	N 12 USA	NL 10 S
FH 12 BR	FM 10 BR	NH 12	NL 12 S
FH 16	FM 12	NH 12 BR	
FH 16 J	FM 12 BR	NL 10 AUS	



Sampa Nr.

030.010

O.E.M. Nr.

1620 443

Dimension

ø130xø134x67

Description

Plastic Bearing

FH 12 BR	FM 12 BR
FH 12	FM 7
FH 16	FM 9
FL 6	NH 12
FM 10	NH 12 BR
FM 10 BR	
FM 12	



Sampa Nr.

030.118

O.E.M. Nr.

1593 522

Dimension

ø163xø177x11

Description

Seal Ring

F 10	FL 10	FM 12 BR	NL 10 AUS
F 12	FL 12	FM 7	NL 10 BR
F 16	FL 6	FM 9	NL 10 S
FH 12	FL 7	N 10 USA	NL 12 AUS
FH 12 BR	FM 10	N 12 USA	NL 12 BR
FH 16	FM 10 BR	NH 12	NL 12 S
FH 16 J	FM 12	NH 12 BR	



Sampa Nr.

030.119

O.E.M. Nr.

1586 520

Dimension

ø160xø183x11

Description

Seal Ring

F 10	FL 10	FM 12 BR	NL 10 BR
F 12	FL 12	FM 7	NL 10 S
F 16	FL 6	FM 9	NL 12 AUS
FH 12	FL 7	NH 12	NL 12 BR
FH 12 BR	FM 10	NH 12	NL 12 S
FH 16	FM 10 BR	NH 12 BR	
FH 16J	FM 12	NL 10 AUS	



Sampa Nr.

030.193

O.E.M. Nr.

1620 742

Dimension

ø186.5xø227.5x0.5

Description

Gasket

F 10	FL 12	FM 9	NL 12 AUS
F 12	FL 6	N 10	NL 12 BR
F 16	FL 7	NH 12	NL12 S
FH 12 BR	FM 10	NH 12 BR	
FH 12	FM 10 BR	NH 12	
FH 16	FM 12	NL 10 AUS	
FH 16 J	FM 12 BR	NL 10 BR	
FL 10	FM 7	NL 10 S	



Sampa Nr.

030.194

O.E.M. Nr.

1590 508

Dimension

ø191xø224x4

Description

Gasket

F 10	FL 10	FM 12 BR	NL 10 BR
F 12	FL 12	FM 7	NL 10 S
F 16	FL 6	FM 9	NL 12 AUS
FH 12 BR	FL 7	NH 12	NL 12 BR
FH 12	FM 10	NH 12 BR	NL 12 S
FH 16	FM 10 BR	NH 12	
FH 16 J	FM 12	NL 10 AUS	

Sampa Nr.
030.251

O.E.M. Nr.
2088 3938



Dimension
M20x2.5/155

Description
Spring Pin

Sampa Nr.
030.252

O.E.M. Nr.
2042 7987



Dimension
M34x4/200

Description
Spring Pin

FH 12
FH 16
FM 12
FM 9

Sampa Nr.
030.053

O.E.M. Nr.
**1598 764
(1576 943)**



Dimension
M24x160

Description
Spring Pin

F 10
F 12
F 16
FL 10
FL 12
FL 7

Sampa Nr.
030.126

O.E.M. Nr.
1504 550



Dimension
M36x3/ø45x104.5

Description
Bushing for Spring Pin

F 10	FL 10	FM 9	NL 10 S
F 12	FL 12	N 10	NL 12 AUS
F 16	FL 6	N 10 USA	NL 12 BR
F 7 USA	FL 7	N 12	NL 12 S
FH 12	FM 10	N 12 USA	
FH 16	FM 12	NL 10 AUS	
FH 16 J	FM 7	NL 10 BR	

Sampa Nr.
030.128

O.E.M. Nr.
1587 940



Dimension
M36x3/ø25x112

Description
Bushing for Spring Pin

F 10
F 12

Sampa Nr.
030.550

O.E.M. Nr.
-



Dimension
M36x3

Description
Rep. Kit Spring Bolt Assembly

F 10
F 12

Spring Suspension

VOLVO



Sampa Nr.

030.123

O.E.M. Nr.

**1608 019
(1598 761)**

Dimension

M45x3/ø25x112

Description

Bushing for Spring Pin

- | | |
|-------|-------|
| F 10 | FL 7 |
| F 12 | FM 10 |
| F 16 | FM 12 |
| FH 12 | FM 7 |
| FH 16 | FM 9 |
| FL 10 | NH 12 |
| FL 12 | |



Sampa Nr.

030.129

O.E.M. Nr.

1598 721

Dimension

M45x3/ø55x104.5

Description

Bushing for Spring Pin

- | | |
|-------|-------|
| F 10 | FL 7 |
| F 12 | FM 10 |
| F 16 | FM 12 |
| FH 12 | FM 7 |
| FH 16 | FM 9 |
| FL 10 | NH 12 |
| FL 12 | |



Sampa Nr.

030.521

O.E.M. Nr.

-

Dimension

M45x3

Description

Rep. Kit Spring Bolt Assembly

- F 10
- F 12
- F 16
- FL 10
- FL 12
- FL 7



Sampa Nr.

030.053

O.E.M. Nr.

**1598 764
(1576 943)**

Dimension

M24x3/160

Description

Spring Pin

- F 10
- F 12
- F 16
- FL 10
- FL 12
- FL 7



Sampa Nr.

030.540

O.E.M. Nr.

**1598 764 S
(1576 943 S)**

Dimension

M24x3/160

Description

Rep. Kit Spring Bolt Assembly

- F 10
- F 12
- F 16
- FL 10
- FL 12
- FL 7

Sampa Nr.

030.122

O.E.M. Nr.

**1608 018
(1598 762)**



Dimension

M45.3x152.5

Description

Bushing for Spring Pin

F 10
F 12
F 16
FL 10
FL 12
FL 7

Sampa Nr.

030.129

O.E.M. Nr.

1598 721



Dimension

M45x3/ø55x104.5

Description

Bushing for Spring Pin

F 10	FL 7
F 12	FM 10
F 16	FM 12
FH 12	FM 7
FH 16	FM 9
FL 10	NH 12
FL 12	

Sampa Nr.

030.523

O.E.M. Nr.

-



Dimension

M45x3

Description

Rep. Kit Spring Bolt Assembly

F 10
F 12
F 16
FL 10
FL 12
FL 7

Sampa Nr.

030.054

O.E.M. Nr.

1598 765



Dimension

M24x3

Description

Spring Pin

F 10
F 12
F 16
FL 10
FL 12
FL 7

Sampa Nr.

030.541

O.E.M. Nr.

1598 765 S



Dimension

M24x3/220

Description

Rep. Kit Spring Bolt Assembly

F 10
F 12
F 16
FL 10
FL 12
FL 7

Spring Suspension

VOLVO



Sampa Nr.
030.123

O.E.M. Nr.
1608 019
(1598 761)

Dimension
M45x3/ø25x112

Description
Bushing for Spring Pin

F 10	FL 7
F 12	FM 10
F 16	FM 12
FH 12	FM 7
FH 16	FM 9
FL 10	NH 12
FL 12	



Sampa Nr.
030.055

O.E.M. Nr.
1598 766
(1622 502)

Dimension
M24x3/172

Description
Spring Pin

F 10	FL 7
F 12	FM 10
F 16	FM 7
FH 12	FM 9
FH 16	FM12
FL 10	NH 12
FL 12	



Sampa Nr.
030.129

O.E.M. Nr.
1598 721

Dimension
M45x3/ø55x104.5

Description
Bushing for Spring Pin

F 10	FL 7
F 12	FM 10
F 16	FM 12
FH 12	FM 7
FH 16	FM 9
FL 10	NH 12
FL 12	



Sampa Nr.
030.542

O.E.M. Nr.
1598 766 S
(1622 502 S)

Dimension
M24x3/170

Description
Rep. Kit Spring Bolt Assembly

F 10	FM 10
F 12	FM 12
F 16	FM 7
FH 12	FM 9
FH 16	NH 12
FL 10	
FL 12	



Sampa Nr.
030.522

O.E.M. Nr.
-

Dimension
M45x3

Description
Rep. Kit Spring Bolt Assembly

F 10
F 12
F 16
FL 10
FL 12
FL 7



Sampa Nr.
030.183

O.E.M. Nr.
351 190

Dimension
M27x3/121.5

Description
Spring Pin

Sampa Nr.
030.117

O.E.M. Nr.
1076 334



Dimension
M38x170

Description
Spring Pin

FH 12 BR	FM 12
FH 12	FM 12 BR
FH 12 J	FM 7
FH 16	FM 9
FH 16 J	NH 12
FM 10	NH 12 BR
FM 10 BR	

Sampa Nr.
030.549

O.E.M. Nr.
-



Dimension

Description
Spring Pin Set

FH 12	FM 10	FM 9
FH 12 BR	FM 10 BR	NH 12
FH 12 J	FM 12	NH 12 BR
FH 16	FM 12 BR	
FH 16 J	FM 7	

Sampa Nr.
030.174

O.E.M. Nr.
3171 036



Dimension
65.5x160x28.5

Description
Spring Bracket

FH 12 BR	FH 16 J	FM 7
FH 12	FM 10	FM 9
FH 12 J	FM 10 BR	NH 12
FH 16	FM 12	
FH 16	FM 12 BR	

Sampa Nr.
030.127

O.E.M. Nr.
1075 726



Dimension
M45x105

Description
Bushing for Spring Pin

FH 12	FM 12
FH 12 BR	FM 12 BR
FH 12 J	FM 7
FH 16	FM 9
FH 16 J	NH 12
FM 10	NH 12 BR
FM 10 BR	

Sampa Nr.
030.130

O.E.M. Nr.
1075 723



Dimension
M38x170

Description
Spring Pin

FH 12 BR	FM 12
FH 12	FM 12 BR
FH 12 J	FM 7
FH 16	FM 9
FH 16 J	NH 12
FM 10	NH 12 BR
FM 10 BR	NH 12

Sampa Nr.
030.548

O.E.M. Nr.
-



Dimension

Description
Spring Pin Set

FH 12	FM 12
FH 12 BR	FM 12 BR
FH 12 J	FM 7
FH 16	FM 9
FH 16 J	NH 12
FM 10	NH 12
FM 10 BR	NH 12 BR

Spring Suspension

VOLVO



Sampa Nr.

030.056

O.E.M. Nr.

6777 141

Dimension

M36x3/150.5

Description

Spring Pin

FE 6 USA
FE 7 USA
FL 6
FL 608-615
FL 616-619
FS 7



Sampa Nr.

030.057

O.E.M. Nr.

6795 567

Dimension

M36x3/160.5

Description

Spring Pin

FL 6
FL 616-619



Sampa Nr.

030.166

O.E.M. Nr.

6776 801

Dimension

M36x3/ø45x79.5

Description

Bushing for Spring Pin

"B 10 B, B 10 BLE" FLC
F 6 USA FS 7
FE 6 USA
FE 7 USA
FL 6
FL 608-615
FL 616-619



Sampa Nr.

030.167

O.E.M. Nr.

6781 880

Dimension

M36x3/ø50x99.5

Description

Bushing for Spring Pin

B 7
B 7 F
B 7 R
FL 6
FL 616-619
FS 7



Sampa Nr.

030.552

O.E.M. Nr.

-

Dimension

M36x3

Description

Spring Pin Set

FE 6 USA
FE 7 USA
FL 6
FL 608-615
FL 616-619
FS 7



Sampa Nr.

030.546

O.E.M. Nr.

-

Dimension

M36x3

Description

Spring Pin Set

FL 6
FL 616-619

Sampa Nr.
030.058

O.E.M. Nr.
6781 881



Dimension
M36x3/171

Description
Spring Pin

FL 6
FL 616-619
FS 7

Sampa Nr.
030.059

O.E.M. Nr.
**1609 960
(363 910)**



Dimension
M36x3/210

Description
Spring Pin

F 10	FL 6	NL 10 S
F 12	FL 75	NL 12 S
F 16	FM 10	
FH 12	FM 12	
FH 16	FM 7	
FL 10	FM 9	
FL 12	N 10	

Sampa Nr.
030.167

O.E.M. Nr.
6781 880



Dimension
M36x3/ø50x99.5

Description
Bushing for Spring Pin

B 7
B 7 F
B 7 R
FL 6
FL 616-619
FS 7

Sampa Nr.
030.126

O.E.M. Nr.
1504 550



Dimension
M36x3/ø45x104.5

Description
Bushing for Spring Pin

F 10	FL 10	FM 9	NL 10 S
F 12	FL 12	N 10	NL 12 AUS
F 16	FL 6	N 10 USA	NL 12 BR
F 7 USA	FL 7	N 12	NL 12 S
FH 12	FM 10	N 12 USA	
FH 16	FM 12	NL 10 AUS	
FH 16 J	FM 7	NL 10 BR	

Sampa Nr.
030.551

O.E.M. Nr.
-



Dimension
M36x3

Description
Spring Pin Set

FL 6
FL 616-619
FS 7

Sampa Nr.
030.519

O.E.M. Nr.
-



Dimension
M36x3

Description
Spring Pin Set

F 10	FL 12	FM 9
F 12	FL 6	N 10
F 16	FL 7	NL 10 S
FH 12	FM 10	NL 12 S
FH 16	FM 12	
FL 10	FM 7	

Spring Suspension

VOLVO



Sampa Nr.

030.060

O.E.M. Nr.

**1614 229
(339 465)**

Dimension

M36x3/169

Description

Spring Pin

F 10	FH 16 J	NL 10 S
F 12	FL 10	NL 12 AUS
F 16	FL 12	NL 12 S
F 7 USA	FL 7	
FH 12	N 10	
FH 12 J	N 12 USA	
FH 16	NL 10 AUS	



Sampa Nr.

030.061

O.E.M. Nr.

**1614 230
(1589 024)**

Dimension

M36x3/169

Description

Spring Pin

F 10	FL 10	NL 10 AUS
F 12	FL 12	NL 10 BR
F 16	FL 7	NL 10 S
FH 12	N 10	NL 12 AUS
FH 12 J	N 10 USA	NL 12 BR
FH 16	N 12	NL 12 S
FH 16 J	N 12 USA	



Sampa Nr.

030.125

O.E.M. Nr.

310 947

Dimension

M36x3/ø45x109.5

Description

Bushing for Spring Pin

B 58 BR
F 10
F 12



Sampa Nr.

030.126

O.E.M. Nr.

1504 550

Dimension

M36x3/ø45x104.5

Description

Bushing for Spring Pin

F 10	FL 10	FM 9	NL 10 S
F 12	FL 12	N 10	NL 12 AUS
F 16	FL 6	N 10 USA	NL 12 BR
F 7 USA	FL 7	N 12	NL 12 S
FH 12	FM 10	N 12 USA	
FH 16	FM 12	NL 10 AUS	
FH 16 J	FM 7	NL 10 BR	



Sampa Nr.

030.547

O.E.M. Nr.

-

Dimension

M36x3

Description

Spring Pin Set

F 10
F 12



Sampa Nr.

030.518

O.E.M. Nr.

-

Dimension

M36x3

Description

Spring Pin Set

F 10	FH 16 J	N 10 USA	NL 10 S
F 12	FL 10	N 12	NL 12 AUS
F 16	FL 12	N 12 USA	NL 12 BR
FH 12	FL 7	NL 10 AUS	NL 12 S
FH 16	N 10	NL 10 BR	

Sampa Nr.
030.060

O.E.M. Nr.
1614 229
(339 465)



Dimension
M36x3/169

Description
Spring Pin

F 10	FH 16 J	NL 10 S
F 12	FL 10	NL 12 AUS
F 16	FL 12	NL 12 S
F 7 USA	FL 7	
FH 12	N 10	
FH 12 J	N 12 USA	
FH 16	NL 10 AUS	

Sampa Nr.
030.170

O.E.M. Nr.
310 948



Dimension
M36x3/M20x2.5x194

Description
Spring Pin

B 58 BR

Sampa Nr.
030.126

O.E.M. Nr.
1504 550



Dimension
M36x3/ø45x104.5

Description
Bushing for Spring Pin

F 10	FL 10	FM 9	NL 10 S
F 12	FL 12	N 10	NL 12 AUS
F 16	FL 6	N 10 USA	NL 12 BR
F 7 USA	FL 7	N 12	NL 12 S
FH 12	FM 10	N 12 USA	
FH 16	FM 12	NL 10 AUS	
FH 16 J	FM 7	NL 10 BR	

Sampa Nr.
030.125

O.E.M. Nr.
310 947



Dimension
M36x3/ø45x109.5

Description
Bushing for Spring Pin

B 58 BR
F 10
F 12

Sampa Nr.
030.524

O.E.M. Nr.
-



Dimension
M36x3

Description
Spring Pin Set

F 10	FH 16 J	NL 10 S
F 12	FL 10	NL 12 AUS
F 16	FL 12	NL 12 S
F 7 USA	FL 7	
FH 12	N 12 USA	
FH 16	NL 10 AUS	

Sampa Nr.
030.557

O.E.M. Nr.
-



Dimension
M36x3

Description
Spring Pin Set

B 58 BR

Spring Suspension

VOLVO



Sampa Nr.

030.170

O.E.M. Nr.

310 948

Dimension

M36x3/M20x2.5x194

Description

Spring Pin

B 58 BR



Sampa Nr.

030.126

O.E.M. Nr.

1504 550

Dimension

M36x3/ø45x104.5

Description

Bushing for Spring Pin

F 10	FL 6	N 12 USA
F 12	FL 7	NL 10 AUS
F 16	FM 10	NL 10 BR
F 7 USA	FM 12	NL 10 S
FH 12	FM 7	NL 12 AUS
FH 16	FM 9	NL 12 BR
FH 16 J	N 10	NL 12 S
FL 10	N 10 USA	
FL 12	N 12	



Sampa Nr.

030.520

O.E.M. Nr.

-

Dimension

M36x3

Description

Spring Pin Set

F 10	FL 12	N 10 USA	NL 12 S
F 12	FL 6	N 12	B 58 BR
F 16	FL 7	N 12 USA	
F 7 USA	FM 10	NL 10 AUS	
FH 12	FM 12	NL 10 BR	
FH 16	FM 7	NL 10 S	
FH 16 J	FM 9	NL 12 AUS	
FL 10	N 10	NL 12 BR	



Sampa Nr.

030.166

O.E.M. Nr.

6776 801

Dimension

M36x3/ø45x79.5

Description

Bushing for Spring Pin

"B 10 B, B 10 BLE" FLC
 F 6 USA FS 7
 FE 6 USA
 FE 7 USA
 FL 6
 FL 608-615
 FL 616-619



Sampa Nr.

030.171

O.E.M. Nr.

6776 803

Dimension

M36x3/140.5

Description

Spring Pin

F 6 USA
 FE 6 USA
 FL 6
 FL 608-615
 FLC



Sampa Nr.

030.543

O.E.M. Nr.

-

Dimension

M36x3

Description

Spring Pin Set

F6 USA
 FE 6 USA
 FL 6
 FL 608-615
 FLC

Sampa Nr.

030.167

O.E.M. Nr.

6781 880



Dimension
M36x3/ø50x99.5

Description

Bushing for Spring Pin

B 7
B 7 F
B 7 R
FL 6
FL 616-619
FS 7

Sampa Nr.

030.169

O.E.M. Nr.

6782 621



Dimension
M36x3/ø20x112

Description

Bushing for Spring Pin

B 7
B 7 F
B 7 R
FL 6
FL 616-619
FS 7

Sampa Nr.

030.533

O.E.M. Nr.

-



Dimension
M20x2.5/155

Description

Rep. Kit Spring Bolt Assembly

B 7
B 7 F
B 7 R
FL 6
FL 616-619
FS 7

Sampa Nr.

030.553

O.E.M. Nr.

-

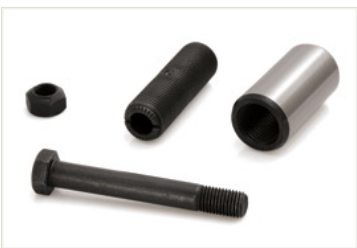

Dimension
M20x2.5/147

Description

Rep. Kit Spring Bolt Assembly

B 7
B 7 F
B 7 R
FL 6
FL 616-619
FS 7

Sampa Nr.

030.538

O.E.M. Nr.

6795 968 S



Dimension
M20x2.5/155

Description

Rep. Kit Spring Bolt Assembly

FL 6
FL 616-619

Sampa Nr.

030.184

O.E.M. Nr.

330 135



Dimension
M36x3/ø45x83

Description

Bushing for Spring Pin

Spring Suspension

VOLVO



Sampa Nr.

030.166

O.E.M. Nr.

6776 801

Dimension

M36x3/ø45x79.5

Description

Bushing for Spring Pin

"B 10 B, B 10 BLE" FL 616-619
 F 6 USA FLC
 FE 6 USA FS 7
 FE 7 USA
 FL 6
 FL 608-615



Sampa Nr.

030.140

O.E.M. Nr.

6771 007

Dimension

ø45.5x80/151

Description

Silent Block

FE 6 USA
 FE 7 USA
 FL 6
 FL 608-615



Sampa Nr.

030.168

O.E.M. Nr.

6776 802

Dimension

M36x3/ø20x92.5

Description

Bushing for Spring Pin

F 6 USA
 FE 6 USA
 FE 7 USA
 FL 6
 FL 608-615
 FLC



Sampa Nr.

030.155

O.E.M. Nr.

1501 677

Dimension

ø51x100/178.5

Description

Silent Block

F 10	N 10	NL 12 AUS
F 12	N 10 USA	NL 12 BR
F 16	N 12	NL 12 S
F 7 USA	N 12 USA	
FL 10	NL 10 AUS	
FL 12	NL 10 BR	
FL 7	NL 10 S	



Sampa Nr.

030.534

O.E.M. Nr.

-

Dimension

M20x2.5/127

Description

Rep. Kit Spring Bolt Assembly

F 6 USA
 FE 6 USA
 FE 7 USA
 FL 6
 FL 608-615
 FLC



Sampa Nr.

030.539

O.E.M. Nr.

6776 804 S

Dimension

M20x2.5/127

Description

Rep. Kit Spring Bolt Assembly

FE 6 USA
 FE 7 USA
 FL 6
 FL 608-615

Sampa Nr.	
030.148	
O.E.M. Nr. 6850 876	
Dimension	ø45.5x100/161
Description	Silent Block
FE 6 USA FE 7 USA FL 6 FL 616-619	

Sampa Nr.	
030.156	
O.E.M. Nr. 6850 874	
Dimension	ø40.5x70/130
Description	Silent Block

Sampa Nr.	
030.151	
O.E.M. Nr. 6850 875	
Dimension	ø45.5x80/140
Description	Silent Block
F 6 USA FE 6 USA FL 6 FL 608-615 FLC	

Sampa Nr.	
030.158	
O.E.M. Nr. 6772 290	
Dimension	ø45.5 x100/171
Description	Silent Block
FE 6 USA FL 6 FL 616-619	

Sampa Nr.	
030.545	
O.E.M. Nr. -	
Dimension	ø45.5
Description	Silent Block Rep. Kit
FE 6 USA FL 6 FL 616-619	

Sampa Nr.	
030.172	
O.E.M. Nr. 343 348	
Dimension	ø51x89/167
Description	Silent Block

Spring Suspension

VOLVO



Sampa Nr.

030.075

O.E.M. Nr.

**1586 089
(1587 103)
(1580 080)**

Dimension

h:150

Description

Spring Cushion

F10
F12
N10 USA
N12 USA



Sampa Nr.

030.076

O.E.M. Nr.

**1609 657
(1577 873)
(8151 413)
(1622 982)**

Dimension

h:151

Description

Spring Cushion

F 10 N 12 USA
F 12 NL 10 AUS
F 16 NL 10 S
FL 10 NL 12 AUS
FL 7 NL 12 S
N 10 USA

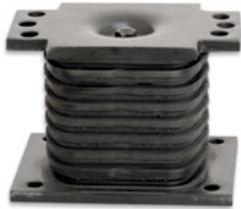

Sampa Nr.

030.078

O.E.M. Nr.

**1629 553
(3090 971)
(1089 501)
(2039 0836)**

Dimension

h:151

Description

Spring Cushion

F 10	FL 7	N 12 USA
F 12	FM 10 BR	NH 12
F 16	FM 12	NH 12
FH 12	FM 12 BR	NH 12 BR
FH 12 BR	FM 7	NL 10 AUS
FH 16	FM 9	NL 10 BR
FH 16 J	FM 10	NL 10 S
FL 10	N 10	NL 12 AUS
FL 12	N 10 USA	NL 12 BR
FL 6	N 12	NL 12 S

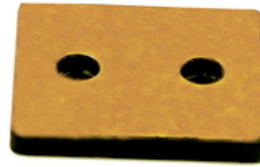

Sampa Nr.

030.087

O.E.M. Nr.

**1591 299
(1598 391)
(1628 397)**

Dimension

90x100x11

Description

Spring Buffer

B 7	FL 12
B 7 F	FL 6
B 7 R	FL 616-619
F 10	FL 7
F 12	NL 10 AUS
F 16	NL 10 S
FE 6 USA	NL 12 AUS
FE 7 USA	NL 12 S
FL 10	

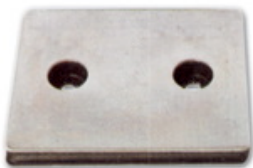

Sampa Nr.

030.088

O.E.M. Nr.

6775 502

Dimension

70x80x11

Description

Spring Buffer

F6 USA
FE 7 USA
FL 6
FL 608-615
FL 616-619
FS 7



Sampa Nr.

030.240

O.E.M. Nr.

1626 139

Dimension

85x140x11/16

Description

Spring Buffer

FH 12	FM 12 BR
FH 12 BR	FM 7
FH 16	FM 9
FM 10	NH 12
FM 10 BR	NH 12
FM 12	NH 12 BR

Spring Suspension

VOLVO

Sampa Nr.

030.081

O.E.M. Nr.

1580 214



Dimension

M12x52

Description

Spring Buffer

F 10	NL 12 AUS
F 12	NL 12 BR
F 16	NL 12 S
F 7 USA	
FL 10	
FL 12	
FL 7	
FM 12	
FM 9	
N 10	
N 10 USA	
N 12	
N 12 USA	
NL 10 AUS	
NL 10 BR	
NL 10 S	

Sampa Nr.

030.084

O.E.M. Nr.

**1506 399
(354 149)**



Dimension

96x118

Description

Spring Buffer

B 7	FM 12
B 7F	FM 7
F 10	FM 9
F 12	FS 7
F 16	N 10
F 7 USA	N 10 USA
FH 12	N 12
FH 16	N 12 USA
FL 10	NH 12
FL 12	NH 12 BR
FL 6	NL 10 AUS
FL 608-615	NL 10 BR
FL 616-619	NL 10 S
FL 7	NL 12 AUS
FLC	NL 12 BR
FM 10	NL12 S

Sampa Nr.

030.091

O.E.M. Nr.

1628 449



Dimension

ø96x92

Description

Spring Buffer

FH 12 BR
FH 12
FH 12 J
FH 16
FH 16 J
FL 608-615
FM 10
FM 10 BR
FM 12
FM 12 BR
FM 7
FM 9
NH 12
NH 12 BR

Sampa Nr.

030.133

O.E.M. Nr.

351 111



Dimension

60x100x40

Description

Spring Buffer

B 7	FLC
B 7 F	FM 10
B 7 R	FM 10 BR
F 10	FM 12
F 12	FM 12 BR
F 16	FM 7
F 6 USA	FM 9
FE 6 USA	FS 7
FE 7 USA	N 10
FH 12	N 12
FH 12 BR	NH 12
FH 16	NH 12 BR
FL 10	NL 10 AUS
FL 12	NL 10 BR
FL 6	NL 10 S
FL 608-615	NL 12 AUS
FL 616-619	NL 12 BR
FL 7	NL 12 S

Cabin

VOLVO



Sampa Nr.

030.165

O.E.M. Nr.

2039 0840

Dimension

ø16xø90x70

Description

Cabin Bushing

FH 12
FM 10
FM 10 BR
FM 12
FM 12 BR
FM 7
FM 9



Sampa Nr.

030.254

O.E.M. Nr.

1076 745

Dimension

ø25/M56x3/150

Description

Cabin Bracket

FH 12
FH 16
FM 10
FM 10 BR
FM 12
FM 12 BR

FM 12 BR
FM 7
FM 9



Sampa Nr.

030.536

O.E.M. Nr.

2039 0840 S

Dimension

ø16xø90x70

Description

Rep. Kit for Cabin

FH 12
FH 16
FM 10
FM 10 BR
FM 12
FM 9
FM 12 BR
FM 7



Sampa Nr.

030.255

O.E.M. Nr.

1076746

Dimension

ø25/M56x3/150

Description

Cabin Bracket

FH 12
FH 16
FM 10
FM 10 BR
FM 12
FM 12 BR
FM 7
FM 9



Sampa Nr.

030.227

O.E.M. Nr.

1591 039

Dimension

ø28.5xø59x60

Description

Cabin Mounting

FL 10
FL 12
FL 7



Sampa Nr.

030.256

O.E.M. Nr.

1075 469

Dimension

M56x3/26.5

Description

Cabin Bracket Plug

FM 7
FM 10
FM 12
FM 12 BR

Sampa Nr.

030.137

O.E.M. Nr.

8143 461



Dimension
ø64xø68x21.5

Description

Cabin Bushing

FH 12 BR
FH 12
FH 12 J
FH 16
FH 16 J

Sampa Nr.

030.212

O.E.M. Nr.

1075 221



Dimension
ø29x81x169x45 LHT

Description

Cabin Bracket

FH 12 BR
FH 12
FH 12 J
FH 16
FH 16 J

Sampa Nr.

030.138

O.E.M. Nr.

**1075 266
(8143 460)**



Dimension
ø30xø68x49

Description

Cabin Mounting

FH 12 BR
FH 12
FH 12 J
FH 16
FH 16 J

Sampa Nr.

030.213

O.E.M. Nr.

1075 223



Dimension
ø29x81x169x45 RHT

Description

Cabin Bracket

FH 12 BR
FH 12
FH 12 J
FH 16
FH 16 J

Sampa Nr.

030.526

O.E.M. Nr.

1075 266 S



Dimension
ø30xø68x49

Description

Rep. Kit for Cabin

FH 12 BR
FH 12
FH 12 J
FH 16
FH 16 J

Sampa Nr.

030.535

O.E.M. Nr.

1075 335 S



Dimension
ø29









Description

Rep. Kit for Cabin

FH 12 BR
FH 12
FH 12 J
FH 16
FH 16 J

Cabin

VOLVO

	<p><i>Sampa Nr.</i> 030.072</p> <p><i>O.E.M. Nr.</i> 3944 648</p>		<p><i>Sampa Nr.</i> 030.073</p> <p><i>O.E.M. Nr.</i> 3944 649</p>
<p><i>Dimension</i> ø25x79/163x144</p>		<p><i>Dimension</i> ø25x79/163x114</p>	
<p><i>Description</i> Cabin Bracket</p>		<p><i>Description</i> Cabin Bracket</p>	
<p>FH 12 FH 12 J</p>	<p>FH 16 FH 16 J</p>	<p>FH 12 FH 12 J</p>	<p>FH 16 FH 16 J</p>
	<p><i>Sampa Nr.</i> 030.074</p> <p><i>O.E.M. Nr.</i> -</p>		<p><i>Sampa Nr.</i> 030.525</p> <p><i>O.E.M. Nr.</i> 1075 399 S</p>
<p><i>Dimension</i> ø25xø30x28</p>		<p><i>Dimension</i> ø25</p>	
<p><i>Description</i> Cabin Bushing</p>		<p><i>Description</i> Rep. Kit for Cabin</p>	
<p>FH 12 FH 12 J</p>	<p>FH 16 FH 16 J</p>	<p>FH 12 FH 12 J</p>	<p>FH 16 FH 16 J</p>
	<p><i>Sampa Nr.</i> 030.204</p> <p><i>O.E.M. Nr.</i> 1096 625</p>		<p><i>Sampa Nr.</i> 030.209</p> <p><i>O.E.M. Nr.</i> 1629 726</p>
<p><i>Dimension</i> ø51x50</p>		<p><i>Dimension</i> ø51x50</p>	
<p><i>Description</i> Buffer for Cabin</p>		<p><i>Description</i> Buffer for Cabin</p>	
<p>FH 12 BR FH 12 FH 12 J</p>	<p>FH 16 FH 16 J</p>	<p>FH 12 BR FH 12 FH 12 J</p>	<p>FH 16 FH 16 J</p>
	<p><i>Sampa Nr.</i> 030.005</p> <p><i>O.E.M. Nr.</i> 8152 645 (1570 910)</p>		<p><i>Sampa Nr.</i> 030.205</p> <p><i>O.E.M. Nr.</i> 1089 014</p>
<p><i>Dimension</i> ø40.5xø50x27.5</p>		<p><i>Dimension</i> M10/SW41x43/70</p>	
<p><i>Description</i> Cabin Bushing</p>		<p><i>Description</i> Buffer for Cabin</p>	
<p>F 10 F 12 F 16</p>		<p>FH 12 BR FH 12 FL 10 FL 12 FL 6 FL 608-615</p>	<p>FL 616-619 FL 7 FLC FM 10 FM 12 FM 7</p>
			<p>FS 7 N 10 USA NL 10 AUS NL 10 S NL 12 AUS NL 12 S</p>

Sampa Nr.
030.030

O.E.M. Nr.
1134 955



Dimension
ø28x57.5x64

Description
Stabilizer Rubber Bushing

"B 10 B, B10 BLE"	F 12	FM 12
B 10 M BR	F 16	FM 7
B 10 M	FH 12 BR	FM 9
B 10 R BR	FH 12 J	FS 7
B 12 BR	FH 16	NH 12
B 12	FH 16 J	NL 10 AUS
B 58 BR	FL 10	NL 10 S
B 6	FL 12	NL 12 AUS
B 7	FL 6	NL 12 S
B 7 F	FL 608-615	
B 7R BR	FL 616-619	
B 7R	FL 7	
F 10	FM 10	

Sampa Nr.
030.107

O.E.M. Nr.
3030 255



Dimension
ø15x97/ø28x122

Description
Stabilizer Bolt

"B 10 B, B10 BLE"	B 7F
B 10 M	B 7R
B 12 (BR)	FL 6
B 12	FL 608-615
B 12 M	FL 616-619
B 6	FS 7
B 7	

Sampa Nr.
030.108

O.E.M. Nr.
1608 758



Dimension
ø13.5x97/ø28x122

Description
Stabilizer Bolt

"B 10 B, B10 BLE"	F 10
B 10 M BR	F 12
B 10 M	F 16
B 10 R BR	FL 10
B 12 BR	FL 12
B 12	FL 7

Sampa Nr.
030.109

O.E.M. Nr.
1135 803



Dimension
ø12x97/ø28x122

Description
Stabilizer Bolt

B 10 M BR
B 10 M
B 10 R
B 12 BR
B 58 BR
B 7
B 7 R

Sampa Nr.
030.150

O.E.M. Nr.
8157 254



Dimension
ø14.5x107/ø28x140

Description
Stabilizer Bolt

F 10	FL 10
F 12	FL 12
F 16	FL 7

Sampa Nr.
030.034

O.E.M. Nr.
1624 605









Dimension
ø17.5xø45x50

Description
Stabilizer Rubber Bushing

FH 12 BR	FL 7
FH 12 J	FM 10
FH 16	FM 12
FH 16 J	FM 7
FL 10	FM 9
FL 12	NH 12

Stabilizer

VOLVO

	<p><i>Sampa Nr.</i></p> <p>030.031</p>		<p><i>Sampa Nr.</i></p> <p>030.257</p>																										
<p><i>Dimension</i></p> <p>ø34xø65.5x64</p>	<p><i>O.E.M. Nr.</i></p> <p>1620 750</p>	<p><i>Dimension</i></p> <p>ø30xø61x55</p>	<p><i>O.E.M. Nr.</i></p> <p>2042 8165</p>																										
<p><i>Description</i></p> <p>Stabilizer Rubber Bushing</p>		<p><i>Description</i></p> <p>Stabilizer Mounting</p>																											
<table border="0"> <tr><td>B 7 R</td><td>FH 12 J</td><td>FM 10</td></tr> <tr><td>B 7 R BR</td><td>FH 16</td><td>FM 12</td></tr> <tr><td>F 10</td><td>FL 10</td><td>FM 7</td></tr> <tr><td>F 12</td><td>FL 12</td><td>FM 9</td></tr> <tr><td>F 16</td><td>FL 6</td><td>NH 12</td></tr> <tr><td>FH 12</td><td>FL 616-619</td><td>NH12 BR</td></tr> <tr><td>FH 12 BR</td><td>FL 7</td><td></td></tr> </table>		B 7 R	FH 12 J	FM 10	B 7 R BR	FH 16	FM 12	F 10	FL 10	FM 7	F 12	FL 12	FM 9	F 16	FL 6	NH 12	FH 12	FL 616-619	NH12 BR	FH 12 BR	FL 7		<table border="0"> <tr><td>FH 12</td></tr> <tr><td>FH 16</td></tr> <tr><td>FM 12</td></tr> <tr><td>FM 9</td></tr> <tr><td>NH 12</td></tr> </table>		FH 12	FH 16	FM 12	FM 9	NH 12
B 7 R	FH 12 J	FM 10																											
B 7 R BR	FH 16	FM 12																											
F 10	FL 10	FM 7																											
F 12	FL 12	FM 9																											
F 16	FL 6	NH 12																											
FH 12	FL 616-619	NH12 BR																											
FH 12 BR	FL 7																												
FH 12																													
FH 16																													
FM 12																													
FM 9																													
NH 12																													
	<p><i>Sampa Nr.</i></p> <p>030.032</p>		<p><i>Sampa Nr.</i></p> <p>030.258</p>																										
<p><i>Dimension</i></p> <p>ø14.5x107/ø34x140</p>	<p><i>O.E.M. Nr.</i></p> <p>8152 450</p>	<p><i>Dimension</i></p> <p>ø35.5xø61x55</p>	<p><i>O.E.M. Nr.</i></p> <p>2042 8166</p>																										
<p><i>Description</i></p> <p>Stabilizer Bolt</p>		<p><i>Description</i></p> <p>Stabilizer Mounting</p>																											
<table border="0"> <tr><td>B 7 R BR</td><td>FH 16</td><td>FM 7</td></tr> <tr><td>B 7 R</td><td>FL 10</td><td>FM 9</td></tr> <tr><td>F 12</td><td>FL 12</td><td>NH 12</td></tr> <tr><td>F 16</td><td>FL 6</td><td>NH 12 BR</td></tr> <tr><td>FH 12 BR</td><td>FL 616-619</td><td></td></tr> <tr><td>FH 12</td><td>FM 10</td><td></td></tr> <tr><td>FH 12 J</td><td>FM 12</td><td></td></tr> </table>		B 7 R BR	FH 16	FM 7	B 7 R	FL 10	FM 9	F 12	FL 12	NH 12	F 16	FL 6	NH 12 BR	FH 12 BR	FL 616-619		FH 12	FM 10		FH 12 J	FM 12		<table border="0"> <tr><td>FH 12</td></tr> <tr><td>FH 16</td></tr> <tr><td>FM 12</td></tr> <tr><td>FM 9</td></tr> <tr><td>NH 12</td></tr> </table>		FH 12	FH 16	FM 12	FM 9	NH 12
B 7 R BR	FH 16	FM 7																											
B 7 R	FL 10	FM 9																											
F 12	FL 12	NH 12																											
F 16	FL 6	NH 12 BR																											
FH 12 BR	FL 616-619																												
FH 12	FM 10																												
FH 12 J	FM 12																												
FH 12																													
FH 16																													
FM 12																													
FM 9																													
NH 12																													
	<p><i>Sampa Nr.</i></p> <p>030.033</p>		<p><i>Sampa Nr.</i></p> <p>030.259</p>																										
<p><i>Dimension</i></p> <p>ø14x97/ø34x127</p>	<p><i>O.E.M. Nr.</i></p> <p>1620 753</p>	<p><i>Dimension</i></p> <p>ø41.5xø61x55</p>	<p><i>O.E.M. Nr.</i></p> <p>2042 8167</p>																										
<p><i>Description</i></p> <p>Stabilizer Bolt</p>		<p><i>Description</i></p> <p>Stabilizer Mounting</p>																											
<table border="0"> <tr><td>F 10</td><td>FL 7</td><td></td></tr> <tr><td>F 12</td><td>FM 10</td><td></td></tr> <tr><td>F 16</td><td>FM 12</td><td></td></tr> <tr><td>FH 12</td><td>FM 7</td><td></td></tr> <tr><td>FH 16</td><td></td><td></td></tr> <tr><td>FL 10</td><td></td><td></td></tr> </table>		F 10	FL 7		F 12	FM 10		F 16	FM 12		FH 12	FM 7		FH 16			FL 10			<table border="0"> <tr><td>FE 6 USA</td></tr> <tr><td>FE 7 USA</td></tr> <tr><td>FL 6</td></tr> <tr><td>FL 608-615</td></tr> </table>		FE 6 USA	FE 7 USA	FL 6	FL 608-615				
F 10	FL 7																												
F 12	FM 10																												
F 16	FM 12																												
FH 12	FM 7																												
FH 16																													
FL 10																													
FE 6 USA																													
FE 7 USA																													
FL 6																													
FL 608-615																													

Sampa Nr.
030.260

O.E.M. Nr.
3173 993



Dimension
ø55x74x70

Description
Stabilizer Mounting

FH 12
FH 16
FM 12
FM 9

Sampa Nr.
030.105

O.E.M. Nr.
9519 245



Dimension
ø59xø90x95

Description
Stabilizer Mounting

B 10 M BR FH 12 BR FM 12
B 10 M FH 12 FM 7
B 10 R BR FH 16 NH 12
B 12 BR FL 10 NH 12 BR
B 12 FL 12 NH 12
B 7 R BR FL 7
B 7 R FM 10

Sampa Nr.
030.261

O.E.M. Nr.
2045 2330



Dimension
ø64xø107x65

Description
Stabilizer Mounting

FM 12
FM 9

Sampa Nr.
030.115

O.E.M. Nr.
1079 256



Dimension
ø65xø116x95

Description
Stabilizer Mounting

FH 12 BR NH 12
FH 12 NH 12 BR
FH 16
FM 10
FM 12
FM 7
FM 9

Sampa Nr.
030.157

O.E.M. Nr.
363 862



Dimension
ø16xø40x120

Description
Stabilizer Rubber Bushing

B 58 BR FL 7
F 10 N 10
F 12 N 12
F 16 NL 10 S
FL 10
FL 12

Sampa Nr.
030.116

O.E.M. Nr.
1077 594





Dimension
ø72x116x95

Description
Stabilizer Mounting

FH 12
FH 16
FM 10
FM 12
FM 7
FM 9
NH 12

Stabilizer

VOLVO

	<p><i>Sampa Nr.</i></p> <p>030.017</p>		<p><i>Sampa Nr.</i></p> <p>030.114</p>
<p><i>Dimension</i></p> <p>ø45xø78x96</p>	<p><i>O.E.M. Nr.</i></p> <p>3028 447</p>	<p><i>Dimension</i></p> <p>ø42xø80x95</p>	<p><i>O.E.M. Nr.</i></p> <p>7030 1194</p>
<p><i>Description</i></p> <p>Stabilizer Mounting</p>		<p><i>Description</i></p> <p>Stabilizer Mounting</p>	
<p>B 10 M BR</p>		<p>“B 10 B, B 10 B LE” B 10 M BR B 12 B B 12 M B 6 B 7 F B 7 L</p>	
	<p><i>Sampa Nr.</i></p> <p>030.018</p>		<p><i>Sampa Nr.</i></p> <p>030.106</p>
<p><i>Dimension</i></p> <p>ø50xø78x96</p>	<p><i>O.E.M. Nr.</i></p> <p>3028 448</p>	<p><i>Dimension</i></p> <p>ø49xø80x95</p>	<p><i>O.E.M. Nr.</i></p> <p>9959 304</p>
<p><i>Description</i></p> <p>Stabilizer Mounting</p>		<p><i>Description</i></p> <p>Stabilizer Mounting</p>	
<p>B 10 M BR B 12 BR B 58 BR</p>		<p>B 9 S B 10 M FL 6 B 7 R B 12 (BR) FL 608-615 B 9 R B 12 B 12 B B 12 B B 12 M B 12 M B 10 B B 7 F B 10 M (BR) B 7 R (BR)</p>	
	<p><i>Sampa Nr.</i></p> <p>030.019</p>		<p><i>Sampa Nr.</i></p> <p>030.104</p>
<p><i>Dimension</i></p> <p>ø55xø78x96</p>	<p><i>O.E.M. Nr.</i></p> <p>3028 449</p>	<p><i>Dimension</i></p> <p>ø53xø80x95</p>	<p><i>O.E.M. Nr.</i></p> <p>9516 524</p>
<p><i>Description</i></p> <p>Stabilizer Mounting</p>		<p><i>Description</i></p> <p>Stabilizer Mounting</p>	
		<p>“B 10 B, B 10 BLE” B 6 FM 12 B 10 M B 6 BLE FM B 12 BR FH 12 BR FM 9 B 12 FH 12 NH 12 B 12 B FH 16 NH 12 BR B 12 M FM 10</p>	

Sampa Nr.
030.006

O.E.M. Nr.
1605 182



Dimension
ø55xø73x95

Description
Stabilizer Plastic Bearing

F 10	FH 12 J	FL 7
F 12	FH 16	FM 10
F 16	FL 10	FM 12
FH 12 BR	FL 12	FM 7
FH 12	FL 6	NH 12

Sampa Nr.
030.007

O.E.M. Nr.
1607 561



Dimension
ø65xø74x96

Description
Stabilizer Plastic Bearing

F 10	FL 12
F 12	FL 6
F 16	FL 7
FH 12	NH 12
FH 12 J	
FH 16	
FL 10	

Sampa Nr.
030.008

O.E.M. Nr.
1605 047



Dimension
ø61xø75x96

Description
Stabilizer Plastic Bearing

B 10 M	FM 10
F 10	FM 12
F 12	FM 7
F 16	
FH 12 BR	
FH 12 J	
FH 16	

Sampa Nr.
030.011

O.E.M. Nr.
1075 188



Dimension
ø59.5xø74x96

Description
Stabilizer Plastic Bearing

FH 12
FH 16
FM 10
FM 12
FM 7
FM 9

Sampa Nr.
030.013

O.E.M. Nr.
1628 318



Dimension
ø53xø70x91

Description
Stabilizer Plastic Bearing

FH 12	FM 12
FH 12 J	FM 7
FH 16	FS 7
FL 6	
FL 616-619	
FM 10	

Sampa Nr.
030.027

O.E.M. Nr.
1622 838









Dimension
ø75xø95x96

Description
Stabilizer Plastic Bearing

F 10	FL 12
F 12	FL 7
F 16	
FH 12	
FH 16	
FL 10	

Stabilizer

VOLVO

	<p><i>Sampa Nr.</i></p> <p>030.029</p>		<p><i>Sampa Nr.</i></p> <p>030.041</p>
<p><i>Dimension</i></p> <p>ø61xø75x96</p>	<p><i>O.E.M. Nr.</i></p> <p>9516 579</p>	<p><i>Dimension</i></p> <p>ø45xø60x70.5</p>	<p><i>O.E.M. Nr.</i></p> <p>6771 515</p>
<p><i>Description</i></p> <p>Stabilizer Plastic Bearing</p>		<p><i>Description</i></p> <p>Stabilizer Plastic Bearing</p>	
<p>B 10 M B 12 BR B 12</p>		<p>B 7 B 7 F FE 6 USA FE 7 USA FL 6 FL 608-615</p> <p>FL 616-619 FLC FS 7</p>	
	<p><i>Sampa Nr.</i></p> <p>030.043</p>		<p><i>Sampa Nr.</i></p> <p>030.101</p>
<p><i>Dimension</i></p> <p>ø43xø61x69</p>	<p><i>O.E.M. Nr.</i></p> <p>6875 470</p>	<p><i>Dimension</i></p> <p>ø69.5xø90x89</p>	<p><i>O.E.M. Nr.</i></p> <p>6799 680</p>
<p><i>Description</i></p> <p>Stabilizer Bearing</p>		<p><i>Description</i></p> <p>Stabilizer Plastic Bearing</p>	
<p>B 7 B 7 F FE 6 USA FE 7 USA FL 608-615</p>		<p>FL 6 FL 608-615 FL 616-619 FS 7</p>	
	<p><i>Sampa Nr.</i></p> <p>030.020</p>		<p><i>Sampa Nr.</i></p> <p>030.021</p>
<p><i>Dimension</i></p> <p>ø49xø90x86</p>	<p><i>O.E.M. Nr.</i></p> <p>1580 010</p>	<p><i>Dimension</i></p> <p>ø30xø66x75</p>	<p><i>O.E.M. Nr.</i></p> <p>1580 009</p>
<p><i>Description</i></p> <p>Stabilizer Bearing</p>		<p><i>Description</i></p> <p>Stabilizer Bearing</p>	
<p>F 10 F 12 F 16 FL 10 FL 12 FL 12</p> <p>FL 608-615 FL 7 NL 10 AUS NL 10 BR NL 10 S NL 12 AUS</p> <p>NL 12 BR NL 12 S</p>		<p>F 10 F 12 F 16 FL 10 FL 12 FL 608-615</p> <p>FL 7 NL 10 AUS NL 10 BR NL 10 S NL 12 AUS NL 12 BR</p> <p>NL 12 S</p>	

Sampa Nr.

030.003

O.E.M. Nr.

1589 807



Dimension
ø25xø35x23

Description

Stabilizer Bushing

B 7	FL 6	N 12
B 7 F	FL 608-615	NL 10
B 7 R	FL 616-619	NL 10 BR
F 10	FL 7	NL 10 S
F 12	FL C	NL 12
F 16	FS 7	NL 12 BR
FL 10	N 10	NL 12 S

Sampa Nr.

030.004

O.E.M. Nr.

1587 261



Dimension
ø25xø35x27

Description

Stabilizer Bushing

F10	NL10 S
F12	NL12 S
F16	
FL10	
FL12	
FL 608-615	
FL7	

Sampa Nr.

030.024

O.E.M. Nr.

1625 954



Dimension
ø17xø25x45

Description

Metal Bushing for Stabilizer

B 6	FL 10	N 12
B 7	FL 6	NL 10 AUS
B 7F	FL 608-615	NL 10 S
B 7R	FL 616-619	NL 12 AUS
F 10	FL 7	NL 12 BR
F 12	FS 7	NL 12 S
F 16	N 10	NL10 BR

Sampa Nr.

030.023

O.E.M. Nr.

1588 445



Dimension
ø17xø25x52

Description

Metal Bushing for Stabilizer

F 10	FL 7
F 12	NL 10 S
F 16	NL 12 S
FL 10	
FL 12	
FL 6	
FL 608-615	

Sampa Nr.

030.516

O.E.M. Nr.

1589 807 S



Dimension
ø25xø35x23

Description

Stabilizer Bearing Kit

F 10	FL 616-619	NL 10 S
F 12	FL 7	NL 12 BR
F 16	N 10	NL 12 S
FL 10	N 12	
FL 6	NL10 BR	

Sampa Nr.

030.517

O.E.M. Nr.

1587 261 S



Dimension
ø25xø35x27







Description

Stabilizer Bearing Kit

F 10	FL 7
F 12	NL 10 S
F 16	NL 12 S
FL 10	
FL 12	
FL 608-615	

Stabilizer

VOLVO

	<p><i>Sampa Nr.</i></p> <p>030.001</p>		<p><i>Sampa Nr.</i></p> <p>030.003</p>
<p><i>Dimension</i></p> <p>ø40x59</p>	<p><i>O.E.M. Nr.</i></p> <p>1611 551</p>	<p><i>Dimension</i></p> <p>ø25xø35x23</p>	<p><i>O.E.M. Nr.</i></p> <p>1589 807</p>
<p><i>Description</i></p> <p>Stabilizer Plastic Bearing</p>		<p><i>Description</i></p> <p>Stabilizer Bushing</p>	
<p>F 10 F 12 F 16 FL 10 FL 12 FL 6 FL 616-619</p>	<p>FL 7 FS 7 N 10 N 12 NL 10 NL 10 BR NL 10 S</p>	<p>NL 12 NL 12 BR NL 12 S</p>	<p>B 7 B 7 F B 7 R F 10 F 12 F 16 FL 10 FL 6 FL 608-615 FL 616-619 FL 7 FL C FS 7 N 10 N 12 NL 10 NL 10 BR NL 10 S NL 12 NL 12 BR NL 12 S</p>
	<p><i>Sampa Nr.</i></p> <p>030.024</p>		<p><i>Sampa Nr.</i></p> <p>030.529</p>
<p><i>Dimension</i></p> <p>ø17xø25x45</p>	<p><i>O.E.M. Nr.</i></p> <p>1625 954</p>	<p><i>Dimension</i></p> <p>-</p>	<p><i>O.E.M. Nr.</i></p> <p>1611 551 S</p>
<p><i>Description</i></p> <p>Metal Bushing for Stabilizer</p>		<p><i>Description</i></p> <p>Stabilizer Bearing Kit</p>	
<p>B 6 B 7 B 7F B 7R F 10 F 12 F 16</p>	<p>FL 10 FL 6 FL 608-615 FL 616-619 FL 7 FS 7 N 10</p>	<p>N 12 NL 10 AUS NL 10 S NL 12 AUS NL 12 BR NL 12 S NL10 BR</p>	<p>F 10 F 12 F 16 FL 10 FL 6 FL 616-619 FL 7 N 10 N 12 NL10 BR NL 10 S NL 12 BR NL 12 S</p>
	<p><i>Sampa Nr.</i></p> <p>030.002</p>		<p><i>Sampa Nr.</i></p> <p>030.012</p>
<p><i>Dimension</i></p> <p>ø35x59</p>	<p><i>O.E.M. Nr.</i></p> <p>1624 611</p>	<p><i>Dimension</i></p> <p>ø45x66</p>	<p><i>O.E.M. Nr.</i></p> <p>1075 180</p>
<p><i>Description</i></p> <p>Stabilizer Plastic Bearing</p>		<p><i>Description</i></p> <p>Stabilizer Plastic Bearing</p>	
<p>FH 12 FH 12 J FH 16 FH 16 J</p>		<p>FH 12 FH 16 FM 10 FM 12 FM 7 FM 9</p>	<p>NH 12 NH 12 BR</p>

Sampa Nr.	
030.035	
O.E.M. Nr. 6772 312 (6856 049)	
Dimension	ø40x56.5
Description Stabilizer Plastic Bearing	
F 6 USA FE 6 USA FE 7 USA FL 6 FL 608-615 FL 616-619 FLC	

Sampa Nr.	
030.036	
O.E.M. Nr. 1075 179	
Dimension	ø35x67
Description Stabilizer Plastic Bearing	
FH 12 BR FM 9 FH 12 J NH 12 FH 16 FH 16 J FM 10 FM 12 FM 7	

Sampa Nr.	
030.149	
O.E.M. Nr. 1076 890	
Dimension	ø40x66
Description Stabilizer Plastic Bearing	
FH 12 FM 7 FH 12 BR FM 9 FH 16 NH 12 FM 10 NH 12 BR FM 10 BR FM 12 FM 12 BR	

Sampa Nr.	
030.014	
O.E.M. Nr. 1575 339	
Dimension	ø49x93.5
Description Stabilizer Bearing	
F 10 FL 6 NL 10 AUS F 12 FL 7 NL 10 S F 16 FM 10 NL 12 AUS FH 12 FM 12 NL 12 S FH 16 FM 7 FL 10 FM 9 FL 12 N 10	

Sampa Nr.	
030.015	
O.E.M. Nr. 1609 768	
Dimension	ø53x75
Description Stabilizer Bearing	
F10 NL10 S F12 NL12 S F16 FL10 FL12 FL7	

Sampa Nr.	
030.016	
O.E.M. Nr. 1573 032	
Dimension	ø50x75
Description Stabilizer Bearing	
F 10 F 12	

Stabilizer

VOLVO

	<p><i>Sampa Nr.</i></p> <p>030.028</p>		<p><i>Sampa Nr.</i></p> <p>030.046</p>																																																																				
<p><i>Dimension</i></p> <p>ø60x94</p>	<p><i>O.E.M. Nr.</i></p> <p>1629 169</p>	<p><i>Dimension</i></p> <p>ø45x75</p>	<p><i>O.E.M. Nr.</i></p> <p>363 864</p>																																																																				
<p><i>Description</i></p> <p>Stabilizer Bearing</p>		<p><i>Description</i></p> <p>Stabilizer Bearing</p>																																																																					
<table border="0"> <tr> <td>FH 12 BR</td> <td>FM 10</td> <td>FM 9</td> </tr> <tr> <td>FH 12</td> <td>FM 10 BR</td> <td>NH 12</td> </tr> <tr> <td>FH 16</td> <td>FM 12</td> <td>NH 12 BR</td> </tr> <tr> <td>FH 16 J</td> <td>FM 12 BR</td> <td>NH 12</td> </tr> <tr> <td>FL 6</td> <td>FM 7</td> <td></td> </tr> </table>		FH 12 BR	FM 10	FM 9	FH 12	FM 10 BR	NH 12	FH 16	FM 12	NH 12 BR	FH 16 J	FM 12 BR	NH 12	FL 6	FM 7																																																								
FH 12 BR	FM 10	FM 9																																																																					
FH 12	FM 10 BR	NH 12																																																																					
FH 16	FM 12	NH 12 BR																																																																					
FH 16 J	FM 12 BR	NH 12																																																																					
FL 6	FM 7																																																																						
	<p><i>Sampa Nr.</i></p> <p>030.102</p>		<p><i>Sampa Nr.</i></p> <p>030.042</p>																																																																				
<p><i>Dimension</i></p> <p>ø55x80</p>	<p><i>O.E.M. Nr.</i></p> <p>1628 112</p>	<p><i>Dimension</i></p> <p>ø25.5xø49.5x23.5</p>	<p><i>O.E.M. Nr.</i></p> <p>6799 335</p>																																																																				
<p><i>Description</i></p> <p>Stabilizer Mounting</p>		<p><i>Description</i></p> <p>Stabilizer Bushing</p>																																																																					
<table border="0"> <tr> <td>FH 12</td> <td>FM 10</td> <td></td> </tr> <tr> <td>FH 12 J</td> <td>FM 12</td> <td></td> </tr> <tr> <td>FH 16</td> <td>FM 7</td> <td></td> </tr> <tr> <td>FH 16 J</td> <td>FM 9</td> <td></td> </tr> <tr> <td>FL 6</td> <td></td> <td></td> </tr> </table>		FH 12	FM 10		FH 12 J	FM 12		FH 16	FM 7		FH 16 J	FM 9		FL 6			<table border="0"> <tr> <td>FE 6 USA</td> <td>FLC</td> </tr> <tr> <td>FE 7 USA</td> <td>FS 7</td> </tr> <tr> <td>FL 6</td> <td></td> </tr> <tr> <td>FL 608-615</td> <td></td> </tr> <tr> <td>FL 616-619</td> <td></td> </tr> </table>		FE 6 USA	FLC	FE 7 USA	FS 7	FL 6		FL 608-615		FL 616-619																																												
FH 12	FM 10																																																																						
FH 12 J	FM 12																																																																						
FH 16	FM 7																																																																						
FH 16 J	FM 9																																																																						
FL 6																																																																							
FE 6 USA	FLC																																																																						
FE 7 USA	FS 7																																																																						
FL 6																																																																							
FL 608-615																																																																							
FL 616-619																																																																							
	<p><i>Sampa Nr.</i></p> <p>030.110</p>		<p><i>Sampa Nr.</i></p> <p>030.111</p>																																																																				
<p><i>Dimension</i></p> <p>M16/27.5x25</p>	<p><i>O.E.M. Nr.</i></p> <p>1135 086</p>	<p><i>Dimension</i></p> <p>ø16xø28x25</p>	<p><i>O.E.M. Nr.</i></p> <p>1135 085</p>																																																																				
<p><i>Description</i></p> <p>Nut for Stabilizer</p>		<p><i>Description</i></p> <p>Metal Bushing for Stabilizer</p>																																																																					
<table border="0"> <tr> <td>F 10</td> <td>FL 6</td> <td></td> <td></td> </tr> <tr> <td>F 12</td> <td>FL 616-619</td> <td></td> <td></td> </tr> <tr> <td>F 16</td> <td>FL 7</td> <td></td> <td></td> </tr> <tr> <td>FH 12</td> <td>FS 7</td> <td></td> <td></td> </tr> <tr> <td>FH 12 J</td> <td>NL 10 AUS</td> <td></td> <td></td> </tr> <tr> <td>FH 16</td> <td>NL 10 S</td> <td></td> <td></td> </tr> <tr> <td>FL 10</td> <td>NL 12 AUS</td> <td></td> <td></td> </tr> <tr> <td>FL 12</td> <td>NL 12 S</td> <td></td> <td></td> </tr> </table>		F 10	FL 6			F 12	FL 616-619			F 16	FL 7			FH 12	FS 7			FH 12 J	NL 10 AUS			FH 16	NL 10 S			FL 10	NL 12 AUS			FL 12	NL 12 S			<table border="0"> <tr> <td>B 10 M BR</td> <td>F 12</td> <td>FL 6</td> <td>FS 7</td> </tr> <tr> <td>B 10 M</td> <td>F 16</td> <td>FL 616-619</td> <td>NH 12 BR</td> </tr> <tr> <td>B 10 R BR</td> <td>FH 12 BR</td> <td>FL 7</td> <td>NH 12</td> </tr> <tr> <td>B 12 BR</td> <td>FH 12</td> <td>FM 10</td> <td>NL 10 AUS</td> </tr> <tr> <td>B 12</td> <td>FH 12 J</td> <td>FM 10 BR</td> <td>NL 10 S</td> </tr> <tr> <td>B 7</td> <td>FH 16</td> <td>FM 12</td> <td>NL 12 AUS</td> </tr> <tr> <td>B 7F</td> <td>FH 16 J</td> <td>FM 12 BR</td> <td>NL 12 S</td> </tr> <tr> <td>B 7R BR</td> <td>FL 10</td> <td>FM 7</td> <td></td> </tr> <tr> <td>F 10</td> <td>FL 12</td> <td>FM 9</td> <td></td> </tr> </table>		B 10 M BR	F 12	FL 6	FS 7	B 10 M	F 16	FL 616-619	NH 12 BR	B 10 R BR	FH 12 BR	FL 7	NH 12	B 12 BR	FH 12	FM 10	NL 10 AUS	B 12	FH 12 J	FM 10 BR	NL 10 S	B 7	FH 16	FM 12	NL 12 AUS	B 7F	FH 16 J	FM 12 BR	NL 12 S	B 7R BR	FL 10	FM 7		F 10	FL 12	FM 9	
F 10	FL 6																																																																						
F 12	FL 616-619																																																																						
F 16	FL 7																																																																						
FH 12	FS 7																																																																						
FH 12 J	NL 10 AUS																																																																						
FH 16	NL 10 S																																																																						
FL 10	NL 12 AUS																																																																						
FL 12	NL 12 S																																																																						
B 10 M BR	F 12	FL 6	FS 7																																																																				
B 10 M	F 16	FL 616-619	NH 12 BR																																																																				
B 10 R BR	FH 12 BR	FL 7	NH 12																																																																				
B 12 BR	FH 12	FM 10	NL 10 AUS																																																																				
B 12	FH 12 J	FM 10 BR	NL 10 S																																																																				
B 7	FH 16	FM 12	NL 12 AUS																																																																				
B 7F	FH 16 J	FM 12 BR	NL 12 S																																																																				
B 7R BR	FL 10	FM 7																																																																					
F 10	FL 12	FM 9																																																																					

Sampa Nr.
030.217

O.E.M. Nr.
348 979



Dimension
ø25xø48x32

Description
Brake Shoe Roller

F 10 N 12
F 12 N 12 USA
F 7 NL 10 BR
N 10 NL 12 BR
N 10 USA

Sampa Nr.
030.219

O.E.M. Nr.
1584 673



Dimension
ø18xø30x86

Description
Brake Shoe Pin

F 10 N 12
F 12 N 12 USA
F 7 USA NL 10 BR
N 10 NL 12 BR
N 10 USA

Sampa Nr.
030.221

O.E.M. Nr.
1586 683
(341 720)

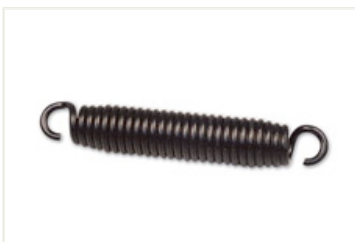

Dimension
ø36.5x204

Description
Brake Shoe Spring

"B 10 B, B 10 BLE"	B 7 F	N 12
B 10 L	B 7 L	N 12 USA
B 10 M BR	B7L DD	NL 10 BR
B 10 M	B 7 R BR	NL 12 BR
B 10 R BR	B 7 R	
B 12 BR	F 10	
B 12	F 12	
B 12 M	F 7 USA	
B 58 BR	N 10	
B 7	N 10 USA	

Sampa Nr.
030.218

O.E.M. Nr.
1584 671



Dimension
ø25x55.5

Description
Brake Shoe Pin

"B 10 B, B10 BLE"	B7 L DD
B 10 L	B 7 R BR
B 10 M BR	B 7 R
B 10 M	F 10
B 10 R BR	F 12
B12 BR	F 7 USA
B 12	N 10
B 12 M	N 10 USA
B 58 BR	N 12
B 7	N 12 USA
B 7 F	NL 10 BR
B7 L	NL 12 BR

Sampa Nr.
030.220

O.E.M. Nr.
1606 679
(348 977)



Dimension
ø30xø34x18

Description
Brake Shoe Bushing

F 10	N 10	N 12 USA
F 12	N 10 USA	NL 10 BR
F 7 USA	N 12	NL 12 BR

Sampa Nr.
030.530

O.E.M. Nr.
348 979 S



Dimension
-

Description
Rep. Kit for Brake Shoe

F 10	N 12
F 12	N 12 USA
F 7 USA	NL 10 BR
N 10	NL 12 BR
N 10 USA	

Brake

VOLVO



Sampa Nr.
030.217

O.E.M. Nr.
348 979

Dimension
ø25xø48x32

Description
Brake Shoe Roller

F 10	N 10	N 12 USA
F 12	N 10 USA	NL 10 BR
F 7	N 12	NL 12 BR



Sampa Nr.
030.218

O.E.M. Nr.
1584 671

Dimension
ø25x55.5

Description
Brake Shoe Pin

"B 10 B, B10 BLE"	B 58 BR	F 12
B 10 L	B 7	F 7 USA
B 10 M BR	B 7 F	N 10
B 10 M	B7 L	N 10 USA
B 10 R BR	B7 L DD	N 12
B12 BR	B 7 R BR	N 12 USA
B 12	B 7 R	NL 10 BR
B 12 M	F 10	NL 12 BR



Sampa Nr.
030.222

O.E.M. Nr.
1586 716
(1584 672)

Dimension
ø17.5xø30x116

Description
Brake Shoe Pin

"B 10 B, B 10 BLE"	B 7 L DD
B 10 L	B 7 R BR
B 10 M BR	B 7 R
B 10 M	F 10
B 10 R BR	F 12
B 12 BR	F 7 USA
B 12	N 10
B 12M	N 10 USA
B 58 BR	N 12
B 7	N 12 USA
B 7 F	NL 10 BR
B 7 L	NL 12 BR



Sampa Nr.
030.223

O.E.M. Nr.
1606 681
(348 978)

Dimension
ø30xø34x24

Description
Brake Shoe Bushing

"B 10 B, B 10 BLE"	B 58 BR	F 12
B 10 L	B 7	F 7 USA
B 10 M BR	B 7 F	N 10
B 10 M	B 7 L	N 10 USA
B 10 R BR	B 7 L DD	N 12
B 12 BR	B 7 R BR	N 12 USA
B 12	B 7 R	NL 10 BR
B 12 M	F 10	NL 12 BR



Sampa Nr.
030.224

O.E.M. Nr.
346 499

Dimension
ø46x201

Description
Brake Shoe Spring

"B 10 B, B 10 BLE"	B 58 BR	F 12
B 10 M BR	B 7	N 10
B 10 M	B 7 F	N 12
B 10 R BR	B 7R BR	NL 10 BR
B 12 BR	B 7 R	NL 12 BR
B 12	F 10	



Sampa Nr.
030.531

O.E.M. Nr.
348 979 S1

Dimension
-

Description
Rep. Kit for Brake Shoe

F 10	N 12
F 12	N 12 USA
F 7 USA	NL 10 BR
N 10	NL 12 BR
N 10 USA	

Sampa Nr.
030.218

O.E.M. Nr.
1584 671



Dimension
ø25x55.5

Description
Brake Shoe Pin

"B 10 B, B10 BLE"	B 58 BR	F 12
B 10 L	B 7	F 7 USA
B 10 M BR	B 7 F	N 10
B 10 M	B 7 L	N 10 USA
B 10 R BR	B 7 L DD	N 12
B12 BR	B 7 R BR	N 12 USA
B 12	B 7 R	NL 10 BR
B 12 M	F 10	NL 12 BR

Sampa Nr.
030.224

O.E.M. Nr.
346 499



Dimension
ø46x201

Description
Brake Shoe Spring

"B 10 B, B 10 BLE"	B 12	B 7 R	NL 10 BR
B 10 M BR	B 58 BR	F 10	NL 12 BR
B 10 M	B 7	F 12	
B 10 R BR	B 7 F	N 10	
B 12 BR	B 7 R BR	N 12	

Sampa Nr.
030.226

O.E.M. Nr.
341 719



Dimension
ø25xø28x28

Description
Brake Shoe Bushing

"B 10 B, B 10 BLE"	B 10 R BR	B 58 BR	B 7 LDD
B 10 L	B 12 BR	B 7	B 7 R BR
B 10 M BR	B 12	B 7 F	B 7 R
B 10 M	B 12 M	B 7 L	

Sampa Nr.
030.532

O.E.M. Nr.
341 717 S



Dimension
-

Description
Rep. Kit for Brake Shoe

F 10	N 10	N 12 USA
F 12	N 10 USA	NL 10 BR
F 7 USA	N 12	NL 12 BR

Sampa Nr.
030.222

O.E.M. Nr.
1586 716
(1584 672)



Dimension
ø17.5xø30x116

Description
Brake Shoe Pin

"B 10 B, B 10 BLE"	B 58 BR	F 12
B 10 L	B 7	F 7 USA
B 10 M BR	B 7 F	N 10
B 10 M	B 7 L	N 10 USA
B 10 R BR	B 7 L DD	N 12
B 12 BR	B 7 R BR	N 12 USA
B 12	B 7 R	NL 10 BR
B 12 M	F 10	NL 12 BR

Sampa Nr.
030.225

O.E.M. Nr.
341 717



Dimension
ø25xø48x32.5

Description
Brake Shoe Roller

"B 10 B, B 10 BLE"	B 12	B 7 F
B 10 L	B 12 BR	B 7 L
B 10 M	B 12 M	B 7 L DD
B 10 M BR	B 58 BR	B 7 R
B 10 R BR	B 7	B 7 R BR

Sampa Nr.
030.223

O.E.M. Nr.
1606 681
(348 978)



Dimension
ø30xø34x24

Description
Brake Shoe Bushing

"B 10 B, B 10 BLE"	B 58 BR	F 12
B 10 L	B 7	F 7 USA
B 10 M BR	B 7 F	N 10
B 10 M	B 7 L	N 10 USA
B 10 R BR	B 7 L DD	N 12
B 12 BR	B 7 R BR	N 12 USA
B 12	B 7 R	NL 10 BR
B 12 M	F 10	NL 12 BR

Brake

VOLVO

	<p>Sampa Nr.</p> <p>030.199</p>		<p>Sampa Nr.</p> <p>030.200</p>																																																											
<p>Dimension</p> <p>ø234xø446x79</p>	<p>O.E.M. Nr.</p> <p>1629 836</p>	<p>Dimension</p> <p>ø234xø446x66</p>	<p>O.E.M. Nr.</p> <p>1629 835</p>																																																											
<p>Description</p> <p>Dust Cover</p>		<p>Description</p> <p>Dust Cover</p>																																																												
<table border="0"> <tr> <td>"B 10 B, B 10 BLE"</td> <td>FH 16</td> <td>FM 9</td> </tr> <tr> <td>B 10 L</td> <td>FL 10</td> <td>NH 12</td> </tr> <tr> <td>B 12</td> <td>FL 12</td> <td>NL 10 S</td> </tr> <tr> <td>B 12 BR</td> <td>FL 6</td> <td>NL 12 S</td> </tr> <tr> <td>F 10</td> <td>FL 7</td> <td></td> </tr> <tr> <td>F 12</td> <td>FM 10</td> <td></td> </tr> <tr> <td>F 16</td> <td>FM 12</td> <td></td> </tr> <tr> <td>FH 12</td> <td>FM 7</td> <td></td> </tr> </table>		"B 10 B, B 10 BLE"	FH 16	FM 9	B 10 L	FL 10	NH 12	B 12	FL 12	NL 10 S	B 12 BR	FL 6	NL 12 S	F 10	FL 7		F 12	FM 10		F 16	FM 12		FH 12	FM 7		<table border="0"> <tr> <td>"B 10 B, B 10 BLE"</td> <td>FH 16</td> <td>FM 12 BR</td> </tr> <tr> <td>B 12</td> <td>FH 16 J</td> <td>FM 7</td> </tr> <tr> <td>B 12 BR</td> <td>FL 10</td> <td>FM 9</td> </tr> <tr> <td>F 10</td> <td>FL 12</td> <td>NH 12</td> </tr> <tr> <td>F 12</td> <td>FL 6</td> <td>NH 12 BR</td> </tr> <tr> <td>F 16</td> <td>FL 7</td> <td>NL 10 AUS</td> </tr> <tr> <td>FH 12</td> <td>FM 10</td> <td>NL 10 S</td> </tr> <tr> <td>FH 12 BR</td> <td>FM 10 BR</td> <td>NL 12 AUS</td> </tr> <tr> <td>FH 12 J</td> <td>FM 12</td> <td>NL 12 S</td> </tr> </table>		"B 10 B, B 10 BLE"	FH 16	FM 12 BR	B 12	FH 16 J	FM 7	B 12 BR	FL 10	FM 9	F 10	FL 12	NH 12	F 12	FL 6	NH 12 BR	F 16	FL 7	NL 10 AUS	FH 12	FM 10	NL 10 S	FH 12 BR	FM 10 BR	NL 12 AUS	FH 12 J	FM 12	NL 12 S								
"B 10 B, B 10 BLE"	FH 16	FM 9																																																												
B 10 L	FL 10	NH 12																																																												
B 12	FL 12	NL 10 S																																																												
B 12 BR	FL 6	NL 12 S																																																												
F 10	FL 7																																																													
F 12	FM 10																																																													
F 16	FM 12																																																													
FH 12	FM 7																																																													
"B 10 B, B 10 BLE"	FH 16	FM 12 BR																																																												
B 12	FH 16 J	FM 7																																																												
B 12 BR	FL 10	FM 9																																																												
F 10	FL 12	NH 12																																																												
F 12	FL 6	NH 12 BR																																																												
F 16	FL 7	NL 10 AUS																																																												
FH 12	FM 10	NL 10 S																																																												
FH 12 BR	FM 10 BR	NL 12 AUS																																																												
FH 12 J	FM 12	NL 12 S																																																												
	<p>Sampa Nr.</p> <p>030.214</p>		<p>Sampa Nr.</p> <p>030.215</p>																																																											
<p>Dimension</p> <p>ø234xø446x29</p>	<p>O.E.M. Nr.</p> <p>1629 832</p>	<p>Dimension</p> <p>ø234xø446x42</p>	<p>O.E.M. Nr.</p> <p>1629 833</p>																																																											
<p>Description</p> <p>Dust Cover</p>		<p>Description</p> <p>Dust Cover</p>																																																												
<table border="0"> <tr> <td>B 12 BR</td> <td>FH 16</td> <td>FM 10</td> </tr> <tr> <td>B 12</td> <td>FL 10</td> <td>FM 12</td> </tr> <tr> <td>F 10</td> <td>FL 12</td> <td>FM 7</td> </tr> <tr> <td>F 12</td> <td>FL 6</td> <td>FM 9</td> </tr> <tr> <td>F 16</td> <td>FL 616-619</td> <td>NL 10 S</td> </tr> <tr> <td>FH 12</td> <td>FL 7</td> <td></td> </tr> </table>		B 12 BR	FH 16	FM 10	B 12	FL 10	FM 12	F 10	FL 12	FM 7	F 12	FL 6	FM 9	F 16	FL 616-619	NL 10 S	FH 12	FL 7		<table border="0"> <tr> <td>F 10</td> <td>FL 10</td> <td>FM 9</td> </tr> <tr> <td>F 12</td> <td>FL 12</td> <td>NH 12</td> </tr> <tr> <td>F 16</td> <td>FL 6</td> <td>NL 10 AUS</td> </tr> <tr> <td>FH 12</td> <td>FL 7</td> <td>NL 10 S</td> </tr> <tr> <td>FH 12 J</td> <td>FM 10</td> <td>NL 12 AUS</td> </tr> <tr> <td>FH 16</td> <td>FM 12</td> <td>NL 12 S</td> </tr> <tr> <td>FH 16 J</td> <td>FM 7</td> <td></td> </tr> </table>		F 10	FL 10	FM 9	F 12	FL 12	NH 12	F 16	FL 6	NL 10 AUS	FH 12	FL 7	NL 10 S	FH 12 J	FM 10	NL 12 AUS	FH 16	FM 12	NL 12 S	FH 16 J	FM 7																					
B 12 BR	FH 16	FM 10																																																												
B 12	FL 10	FM 12																																																												
F 10	FL 12	FM 7																																																												
F 12	FL 6	FM 9																																																												
F 16	FL 616-619	NL 10 S																																																												
FH 12	FL 7																																																													
F 10	FL 10	FM 9																																																												
F 12	FL 12	NH 12																																																												
F 16	FL 6	NL 10 AUS																																																												
FH 12	FL 7	NL 10 S																																																												
FH 12 J	FM 10	NL 12 AUS																																																												
FH 16	FM 12	NL 12 S																																																												
FH 16 J	FM 7																																																													
	<p>Sampa Nr.</p> <p>030.216</p>		<p>Sampa Nr.</p> <p>030.235</p>																																																											
<p>Dimension</p> <p>ø234xø446x54</p>	<p>O.E.M. Nr.</p> <p>1629 834 (2036 7343)</p>	<p>Dimension</p> <p>ø44xø49x30</p>	<p>O.E.M. Nr.</p> <p>1606 683</p>																																																											
<p>Description</p> <p>Dust Cover</p>		<p>Description</p> <p>Brake Camshaft Bushing</p>																																																												
<table border="0"> <tr> <td>F 10</td> <td>FL 10</td> <td>FM 7</td> <td>SUPER-OLYMPIAN</td> </tr> <tr> <td>F 12</td> <td>FL 12</td> <td>FM 9</td> <td></td> </tr> <tr> <td>F 16</td> <td>FL 6</td> <td>NH 12</td> <td></td> </tr> <tr> <td>FH 12</td> <td>FL 7</td> <td>NH 12 BR</td> <td></td> </tr> <tr> <td>FH 12 BR</td> <td>FM 10</td> <td>NL 10 AUS</td> <td></td> </tr> <tr> <td>FH 12 J</td> <td>FM 10 BR</td> <td>NL 10 S</td> <td></td> </tr> <tr> <td>FH 16</td> <td>FM 12</td> <td>NL 12 S</td> <td></td> </tr> <tr> <td>FH 16 J</td> <td>FM 12 BR</td> <td>OLYMPIAN MKII</td> <td></td> </tr> </table>		F 10	FL 10	FM 7	SUPER-OLYMPIAN	F 12	FL 12	FM 9		F 16	FL 6	NH 12		FH 12	FL 7	NH 12 BR		FH 12 BR	FM 10	NL 10 AUS		FH 12 J	FM 10 BR	NL 10 S		FH 16	FM 12	NL 12 S		FH 16 J	FM 12 BR	OLYMPIAN MKII		<table border="0"> <tr> <td>"B 10 B, B 10 BLE"</td> <td>B 7</td> <td>N 10</td> </tr> <tr> <td>B 10 L</td> <td>B 7 F</td> <td>N 10 USA</td> </tr> <tr> <td>B 10 M BR</td> <td>B 7 L</td> <td>N 12</td> </tr> <tr> <td>B 10 M</td> <td>B 7 L DD</td> <td>N 12 USA</td> </tr> <tr> <td>B 10 R BR</td> <td>B 7 R BR</td> <td>NL 10 BR</td> </tr> <tr> <td>B12 BR</td> <td>B 7 R</td> <td>NL 12 BR</td> </tr> <tr> <td>B 12</td> <td>F 10</td> <td></td> </tr> <tr> <td>B 12 M</td> <td>F 12</td> <td></td> </tr> <tr> <td>B 58 BR</td> <td>F 7 USA</td> <td></td> </tr> </table>		"B 10 B, B 10 BLE"	B 7	N 10	B 10 L	B 7 F	N 10 USA	B 10 M BR	B 7 L	N 12	B 10 M	B 7 L DD	N 12 USA	B 10 R BR	B 7 R BR	NL 10 BR	B12 BR	B 7 R	NL 12 BR	B 12	F 10		B 12 M	F 12		B 58 BR	F 7 USA	
F 10	FL 10	FM 7	SUPER-OLYMPIAN																																																											
F 12	FL 12	FM 9																																																												
F 16	FL 6	NH 12																																																												
FH 12	FL 7	NH 12 BR																																																												
FH 12 BR	FM 10	NL 10 AUS																																																												
FH 12 J	FM 10 BR	NL 10 S																																																												
FH 16	FM 12	NL 12 S																																																												
FH 16 J	FM 12 BR	OLYMPIAN MKII																																																												
"B 10 B, B 10 BLE"	B 7	N 10																																																												
B 10 L	B 7 F	N 10 USA																																																												
B 10 M BR	B 7 L	N 12																																																												
B 10 M	B 7 L DD	N 12 USA																																																												
B 10 R BR	B 7 R BR	NL 10 BR																																																												
B12 BR	B 7 R	NL 12 BR																																																												
B 12	F 10																																																													
B 12 M	F 12																																																													
B 58 BR	F 7 USA																																																													

Sampa Nr.

030.026

O.E.M. Nr.

**3097 092
(1696 444)**



Dimension
73x295

Description

Return Spring

"B 10 B, B 10 BLE"	FM 10
B 10 L	FM 10 BR
B 12	FM 12
B 12 BR	FM 12 BR
F 10	FM 7
F 12	FM 9
F 16	NH 12
FH 12	NH 12 BR
FH 12 BR	NL 10 AUS
FH 12 J	NL 10 S
FH 16	NL 12 AUS
FH 16 J	NL 12 S
FL 10	OLYMPIAN MKII
FL 12	SUPER OLYMPIAN
FL 6	
FL 616-619	
FL 7	

Sampa Nr.

060.144

O.E.M. Nr.

1695 051



Dimension
ø24x216

Description

Brake Shoe Spring

FL 6
FL 616-619

Sampa Nr.

060.525

O.E.M. Nr.

272 857



Dimension

Description

Brake Adjuster Rep. Kit

FL 6
FL 616-619

Sampa Nr.

030.248

O.E.M. Nr.

**3090 954
(1696 448)**



Dimension
ø36xø63x19

Description

Dust Cover

"B 10 B, B 10 BLE"	FM 10
B 10 L	FM 10 BR
B 12	FM 12
B 12 BR	FM 12 BR
F 10	FM 7
F 12	FM 9
F 16	NH 12
FH 12	NH 12 BR
FH 12 BR	NL10 AUS
FH 12 J	NL10 S
FH 16	NL12 AUS
FH 16 J	NL12 S
FL 10	OLYMPIAN MKII
FL 12	SUPEROLYMPIAN
FL 616-619	
FL 7	
FL6	

Sampa Nr.

O.E.M. Nr.

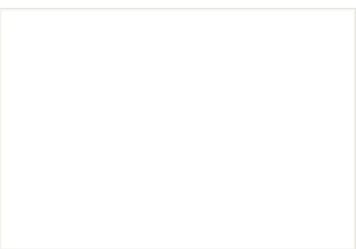









Dimension

Description

Brake

VOLVO

	<p><i>Sampa Nr.</i></p> <p>095.509</p> <p><i>O.E.M. Nr.</i></p> <p>MCK-1171/N</p>		<p><i>Sampa Nr.</i></p> <p>095.510</p> <p><i>O.E.M. Nr.</i></p> <p>MCK-1102/N</p>
<p><i>Dimension</i></p>		<p><i>Dimension</i></p>	
<p><i>Description</i></p> <p>Rep. Kit for Brake Caliper</p>		<p><i>Description</i></p> <p>Rep. Kit for Brake Caliper</p>	
	<p><i>Sampa Nr.</i></p> <p>095.511</p> <p><i>O.E.M. Nr.</i></p> <p>MCK 1253</p>		<p><i>Sampa Nr.</i></p> <p>095.512</p> <p><i>O.E.M. Nr.</i></p> <p>MCK 1254</p>
<p><i>Dimension</i></p>		<p><i>Dimension</i></p>	
<p><i>Description</i></p> <p>Rep. Kit for Brake Caliper</p>		<p><i>Description</i></p> <p>Rep. Kit for Brake Caliper</p>	
	<p><i>Sampa Nr.</i></p> <p>095.513</p> <p><i>O.E.M. Nr.</i></p> <p>MCK 1139</p>		<p><i>Sampa Nr.</i></p> <p>095.514</p> <p><i>O.E.M. Nr.</i></p> <p>MCK 1238</p>
<p><i>Dimension</i></p>		<p><i>Dimension</i></p>	
<p><i>Description</i></p> <p>Rep. Kit for Brake Caliper</p>		<p><i>Description</i></p> <p>Rep. Kit for Brake Caliper</p>	
	<p><i>Sampa Nr.</i></p> <p>095.515</p> <p><i>O.E.M. Nr.</i></p> <p>MCK 1171</p>		<p><i>Sampa Nr.</i></p> <p>095.516</p> <p><i>O.E.M. Nr.</i></p> <p>MCK 1192</p>
<p><i>Dimension</i></p>		<p><i>Dimension</i></p>	
<p><i>Description</i></p> <p>Rep. Kit for Brake Caliper</p>		<p><i>Description</i></p> <p>Rep. Kit for Brake Caliper</p>	

<i>Sampa Nr.</i>	
095.524	
<i>O.E.M. Nr.</i> K 001300	
<i>Dimension</i>	
<i>Description</i>	
Rep. Kit for Brake Caliper	

<i>Sampa Nr.</i>	
095.572	
<i>O.E.M. Nr.</i> K 010603	
<i>Dimension</i>	
<i>Description</i>	
Rep. Kit for Brake Caliper	

<i>Sampa Nr.</i>	
095.573	
<i>O.E.M. Nr.</i> K 010604	
<i>Dimension</i>	
<i>Description</i>	
Rep. Kit for Brake Caliper	

<i>Sampa Nr.</i>	
095.581	
<i>O.E.M. Nr.</i> K 000944	
<i>Dimension</i>	
<i>Description</i>	
Rep. Kit for Brake Caliper	

<i>Sampa Nr.</i>	
095.521	
<i>O.E.M. Nr.</i> II 304130065	
<i>Dimension</i>	
<i>Description</i>	
Rep. Kit for Brake Caliper	









<i>Sampa Nr.</i>	
095.519	
<i>O.E.M. Nr.</i> K 000696	
<i>Dimension</i>	
<i>Description</i>	
Rep. Kit for Brake Caliper	

<i>Sampa Nr.</i>	
095.520	
<i>O.E.M. Nr.</i> K 000687	
<i>Dimension</i>	
<i>Description</i>	
Rep. Kit for Brake Caliper	

<i>Sampa Nr.</i>	
095.525	
<i>O.E.M. Nr.</i> II 358510062	
<i>Dimension</i>	
<i>Description</i>	
Rep. Kit for Brake Caliper	

Brake

VOLVO

	<p><i>Sampa Nr.</i></p> <p>095.530</p> <p><i>O.E.M. Nr.</i></p> <p>K 001274</p>		<p><i>Sampa Nr.</i></p> <p>095.531</p> <p><i>O.E.M. Nr.</i></p> <p>K 000375</p>
<p><i>Dimension</i></p>		<p><i>Dimension</i></p>	
<p><i>Description</i></p> <p>Rep. Kit for Brake Caliper</p>		<p><i>Description</i></p> <p>Rep. Kit for Brake Caliper</p>	
	<p><i>Sampa Nr.</i></p> <p>095.533</p> <p><i>O.E.M. Nr.</i></p> <p>II 339680062 (II 328090062) (II 369100062)</p>		<p><i>Sampa Nr.</i></p> <p>095.568</p> <p><i>O.E.M. Nr.</i></p> <p>K 000472</p>
<p><i>Dimension</i></p>		<p><i>Dimension</i></p>	
<p><i>Description</i></p> <p>Rep. Kit for Brake Caliper</p>		<p><i>Description</i></p> <p>Rep. Kit for Brake Caliper</p>	
	<p><i>Sampa Nr.</i></p> <p>095.569</p> <p><i>O.E.M. Nr.</i></p> <p>K 001925</p>		<p><i>Sampa Nr.</i></p> <p>095.570</p> <p><i>O.E.M. Nr.</i></p> <p>K 001532</p>
<p><i>Dimension</i></p>		<p><i>Dimension</i></p>	
<p><i>Description</i></p> <p>Rep. Kit for Brake Caliper</p>		<p><i>Description</i></p> <p>Rep. Kit for Brake Caliper</p>	
	<p><i>Sampa Nr.</i></p> <p>095.526</p> <p><i>O.E.M. Nr.</i></p> <p>93161192</p>		<p><i>Sampa Nr.</i></p> <p>095.518</p> <p><i>O.E.M. Nr.</i></p> <p>II 368470064</p>
<p><i>Dimension</i></p>		<p><i>Dimension</i></p>	
<p><i>Description</i></p> <p>Rep. Kit for Brake Caliper</p>		<p><i>Description</i></p> <p>Rep. Kit for Brake Caliper</p>	

<i>Sampa Nr.</i>	
095.527	
<i>O.E.M. Nr.</i> II 197140062	
<i>Description</i>	<i>Dimension</i>
Rep. Kit for Brake Caliper	

<i>Sampa Nr.</i>	
095.528	
<i>O.E.M. Nr.</i> II 179320062	
<i>Description</i>	<i>Dimension</i>
Rep. Kit for Brake Caliper	

<i>Sampa Nr.</i>	
095.529	
<i>O.E.M. Nr.</i> II 197330062	
<i>Description</i>	<i>Dimension</i>
Rep. Kit for Brake Caliper	

<i>Sampa Nr.</i>	
095.522	
<i>O.E.M. Nr.</i> II 39769F0063	
<i>Description</i>	<i>Dimension</i>
Rep. Kit for Brake Caliper	

<i>Sampa Nr.</i>	
095.571	
<i>O.E.M. Nr.</i> K 001301	
<i>Description</i>	<i>Dimension</i>
Rep. Kit for Brake Caliper	



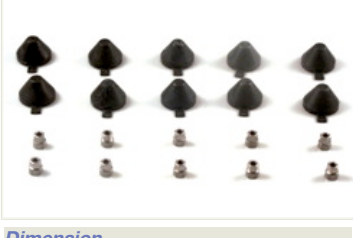

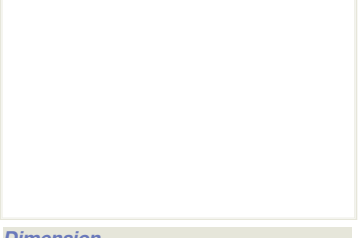



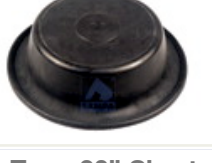

<i>Sampa Nr.</i>	
095.523	
<i>O.E.M. Nr.</i> K 000945	
<i>Description</i>	<i>Dimension</i>
Rep. Kit for Brake Caliper	

<i>Sampa Nr.</i>	
095.567	
<i>O.E.M. Nr.</i> K 000029	
<i>Description</i>	<i>Dimension</i>
Rep. Kit for Brake Caliper	

<i>Sampa Nr.</i>	
095.567	
<i>O.E.M. Nr.</i> K 000029	
<i>Description</i>	<i>Dimension</i>
Rep. Kit for Brake Caliper	

DIAPHRAGMS

VOLVO

	<p><i>Sampa Nr.</i></p> <p>095.101</p> <p><i>O.E.M. Nr.</i></p> <p>897 120 492.4 (353 314)</p>		<p><i>Sampa Nr.</i></p> <p>095.108</p> <p><i>O.E.M. Nr.</i></p> <p>897 120 540.4 (1614 799) -(1609 311) - (1588 818)</p>
<p>Type 9" Short</p> <p><i>Description</i></p> <p>Short Stroke</p>		<p>Type 30" Short</p> <p><i>Description</i></p> <p>Short Stroke</p>	
	<p><i>Sampa Nr.</i></p> <p>095.103</p> <p><i>O.E.M. Nr.</i></p> <p>897 120 505.4 (325 197)</p>		<p><i>Sampa Nr.</i></p> <p>095.109</p> <p><i>O.E.M. Nr.</i></p> <p>897 120 550.4 (1518 741)</p>
<p>Type 12" Short</p> <p><i>Description</i></p> <p>Short Stroke</p>		<p>Type 36" Short</p> <p><i>Description</i></p> <p>Short Stroke</p>	
	<p><i>Sampa Nr.</i></p> <p>095.105</p> <p><i>O.E.M. Nr.</i></p> <p>897 120 510.4 (1614 796) - (1609 308) - (325 867)</p>		<p><i>Sampa Nr.</i></p> <p>095.110</p> <p><i>O.E.M. Nr.</i></p> <p>897 120 516.4 (3090 848)</p>
<p>Type 16" Short</p> <p><i>Description</i></p> <p>Short Stroke</p>		<p>Type 16" Long</p> <p><i>Description</i></p> <p>Long Stroke</p>	
	<p><i>Sampa Nr.</i></p> <p>095.106</p> <p><i>O.E.M. Nr.</i></p> <p>897 120 520.4 (1614 797) - (1609 309) - (338 458)</p>		<p><i>Sampa Nr.</i></p> <p>095.111</p> <p><i>O.E.M. Nr.</i></p> <p>897 120 526.4</p>
<p>Type 20" Short</p> <p><i>Description</i></p> <p>Short Stroke</p>		<p>Type 20" Long</p> <p><i>Description</i></p> <p>Long Stroke</p>	
	<p><i>Sampa Nr.</i></p> <p>095.107</p> <p><i>O.E.M. Nr.</i></p> <p>897 120 530.4 (1614 798) - (1609 310) - (338 452)</p>		<p><i>Sampa Nr.</i></p> <p>095.112</p> <p><i>O.E.M. Nr.</i></p> <p>897 120 536.4 (1698 126)</p>
<p>Type 24" Short</p> <p><i>Description</i></p> <p>Short Stroke</p>		<p>Type 24" Long</p> <p><i>Description</i></p> <p>Long Stroke</p>	
	<p><i>Sampa Nr.</i></p> <p>095.107</p> <p><i>O.E.M. Nr.</i></p> <p>897 120 530.4 (1614 798) - (1609 310) - (338 452)</p>		<p><i>Sampa Nr.</i></p> <p>095.113</p> <p><i>O.E.M. Nr.</i></p> <p>897 120 546.4</p>
<p>Type 24" Short</p> <p><i>Description</i></p> <p>Short Stroke</p>		<p>Type 30" Long</p> <p><i>Description</i></p> <p>Long Stroke</p>	

Sampa Nr.

030.243

O.E.M. Nr.

191 178



Dimension
ø80.5 W12G / 13 x SW105

Description

Axle Nut

"B 10 B, B 10 BLE"	F 16	FS 7
B 10 L	F 7 USA	N 10
B 10 M	FE 6 USA	N 10 USA
B 10 R BR	FE 7 USA	N 12
B 12	FH 12	N 12 USA
B 58 BR	FH 12J	NH 12
B 7	FH 16	NL 10 AUS
B 7 F	FL 10	NL 10 BR
B 7 L	FL 12	NL 10 S
B 7 L DD	FL 6	NL 12 AUS
B 7 R	FL 616-619	NL 12 BR
B 7 R BR	FL 7	NL 12 S
B10 M BR	FM 10	OLYMPIAN MKII
B12 BR	FM 12	SUPEROLYMPIAN
F 10	FM 7	
F 12	FM 9	

Sampa Nr.

030.244

O.E.M. Nr.

324 665



Dimension
ø80.5 W12G / 13 x SW105

Description

Axle Nut

"B 10 B, B10BLE"	B 7 L	FH 12 J
B 10 L	B 7 L DD	FH 16
B 10 M BR	B 7 R BR	FL 10
B 10 M	B 7 R	FL 6
B 10 R BR	F 10	FL 616-619
B 12 BR	F 12	FL 7
B 12	F 16	FS 7
B 58 BR	F 7 USA	N 10
B 7	FH 12	

Sampa Nr.

030.245

O.E.M. Nr.

1522 384



Dimension
M80 x 2 / 17 x SW95

Description

Axle Nut

B 10 M BR	FH 16 J	FM 12 BR	NL 10 AUS
F 10	FL 10	FM 7	NL 10 BR
F 12	FL 12	FM 9	NL 10 S
F 16	FL 7	N 10	NL 12 AUS
FH 12 BR	FM 10	NH 12	NL 12 BR
FH 12	FM 10 BR	NH 12 BR	NL 12 S
FH 16	FM 12	NH 12	

Sampa Nr.

030.246

O.E.M. Nr.

3985 590

(1625 712)

(3963 419)



Dimension
M115x2/62xSW115

Description

Hub Cap

FL 10	FH 16	NL 10 AUS
"B 10 B, B 10 BLE"	FH 16 J	NL 10 S
B 10 L	FL 10	NL 12 AUS
B 10 M	FL 12	NL12 S
B 12	FL 6	OLYMPIAN MKII
B 12 B	FL 616-619	SUPEROLYMPIAN
B 7	FL 7	
B 7 F	FM 10	
B 7 L	FM 10 BR	
B 7 L DD	FM 12	
B 7 R	FM 12 BR	
F 10	FM 7	
F 12	FM 9	
F 16	FS 7	
F 7 USA	N 10 USA	
FE 7 USA	N 12 USA	
FH 12	NH 12	
FH 12 BR	NH 12	
FH 12 J	NH 12 BR	

Sampa Nr.

030.247

O.E.M. Nr.

2 0390 132



Dimension
M30x2/27





Description

Hub Cap Plug

"B 10 B, B 10 BLE"	FL 616-619
B 10 L	FL 7
B 10 M	FM 10
B 12	FM 10 BR
B 12 B	FM 12
B 7	FM 12 BR
B 7 F	FM 7
B 7 L	FM 9
B 7 L DD	FS7
B 7 R	NH 12
F 12	NH 12 BR
F 16	NH 12
FH 12 BR	NL 10 AUS
FH 12	NL 10 S
FH 12 J	NL 12 AUS
FH 16	NL 12 S
FH 16 J	OLYMPIAN MKII
FL 10	SUPEROLYMPIAN
FL 12	
FL 6	

Wheel - Axle

VOLVO

	<p>Sampa Nr.</p> <p>030.249</p> <p>O.E.M. Nr.</p> <p>3038 061</p>		<p>Sampa Nr.</p> <p>030.070</p> <p>O.E.M. Nr.</p> <p>1575 525</p>
<p>Dimension</p> <p>M115x2/40.5/SW115</p>		<p>Dimension</p> <p>ø50xø84.5x2</p>	
<p>Description</p> <p>Hub Cap</p>		<p>Description</p> <p>Lock Washer</p>	
<p>B 10 M B 58 BR F 10 F 12 N 10 N 12</p>		<p>B 10 M BR B 58 BR F 10 F 10 F 12 F 7 USA FL 10</p>	<p>FL 7 N 10 N10 USA N 12 N12 USA</p>
	<p>Sampa Nr.</p> <p>030.197</p> <p>O.E.M. Nr.</p> <p>1591 023</p>		<p>Sampa Nr.</p> <p>030.071</p> <p>O.E.M. Nr.</p> <p>191 179</p>
<p>Dimension</p> <p>99.5x220x110</p>		<p>Dimension</p> <p>ø83xø121x3</p>	
<p>Description</p> <p>Bearing Half for Axle</p>		<p>Description</p> <p>Lock Washer</p>	
<p>F 10 F 12 F 16 FH 12 FH 16 FL 10</p>	<p>FL 12 FL 6 FL 7 FM 10 FM 12 FM 7</p>	<p>FM 9 NL 10 S NL 12 S</p>	
	<p>Sampa Nr.</p> <p>030.208</p> <p>O.E.M. Nr.</p> <p>1628 217</p>		
<p>Dimension</p> <p>124x334x115</p>			
<p>Description</p> <p>Bearing Half for Axle</p>			
<p>FH 12 FH 16 FL 6 FM 10 FM 12 FM 7 FM 9</p>		<p>"B 10B, B10 BLE" B 10 L B 10 M BR B 10 R BR B 12 BR B 58 BR B 7 B 7 F B 7 L B 7 L DD B 7R BR B 7R F 10 F 12 F 16 F 7 USA FE 6 USA FE 7 USA FH 12 FH 12 J FH 16 FL 10 FL 12 FL 6 FL 616-619</p>	<p>FL 7 FS 7 N 10 N 10 USA N 12 N 12 USA NH 12 NL 10 AUS NL 10 BR NL 10 S NL 12 AUS NL 12 BR NL 12 S OLYMPIAN MKII SUPEROLYMPIAN</p>

Sampa Nr.
030.509

O.E.M. Nr.
276 029
(276 014)



Dimension
ø34/ø45x237

Description
King Pin Set, Without Bearing Single

Sampa Nr.
030.509/1

O.E.M. Nr.
276 029 S
(276 014 S)



Dimension
ø34/ø45x237

Description
King Pin Set, Without Bearing Double

Sampa Nr.
030.509/2

O.E.M. Nr.
276 029 S1
(276 014 S1)



Dimension
ø34/ø45x237

Description
King Pin Set, With Bearing Single

Sampa Nr.
030.509/3

O.E.M. Nr.
276 029 S2
(276 014 S2)



Dimension
ø34/ø45x237

Description
King Pin Set, With Bearing Double

B 57 / B 58
B 59
B 715 / B 755
"F 86 / FB 86 FA 6,0"
F 88 / FB 88 / G 88

F 89 / G 89
N 7
N 10
N 12

Sampa Nr.
030.510

O.E.M. Nr.
3090 266
(271 142)
(276 031)
(270 912)
(276 023)



Dimension
M36xø38/ø50x251

Description
King Pin Set, Without Bearing Single

Sampa Nr.
030.510/1

O.E.M. Nr.
3090 266 S
(271 142 S)
(276 031 S)
(270 912 S)
(276 023 S)



Dimension
M36xø38/ø50x251

Description
King Pin Set, Without Bearing Double

"B 10 B, B 10 BLE"
B 10 L
B 10 M
B 12 BR
B 12
B 12 B
B 7 L
B 7 L DD
B 7 R
F 10
F 10
F 12

F 16
F 7 USA
FH 12 BR
FH 12
FH 12 J
FH 16
FH 16 J
FL 10
FL 12
FL 6
FL 616-619
FL 7

FM 10
FM 10 BR
FM 12
FM 12 BR
FM 7
FS 7
N 10
N 10 USA
N 12
N 12 USA
NH 12
NH 12 BR

NH 12
NL 10 AUS
NL 10 BR
NL 10 S
NL 12 AUS
NL 12 BR
NL 12 S
OLYMPIAN MKII
SUPEROLYMPIAN

Wheel - Axle

VOLVO



Sampa Nr.

030.510/2

O.E.M. Nr.

3090 266 S1
(271 142 S1)
(276 031 S1)
(270 912 S1)
(276 023 S1)

Dimension

M36xø38/ø50x251

Description

King Pin Set, With Bearing Single



Sampa Nr.

030.510/3

O.E.M. Nr.

3090 266 S2
(271 142 S2)
(276 031 S2)
(270 912 S2)
(276 023 S2)

Dimension

M36xø38/ø50x251

Description

King Pin Set, With Bearing Double

"B 10 B, B 10 BLE"	B 7 R	FH 12 J	FM 10	N 12	NL 12 AUS
B 10 L	F 10	FH 16	FM 10 BR	N 12 USA	
B 10 M	F 10	FH 16 J	FM 12	NH 12	NL 12 BR
B 12 BR	F 12	FL 10	FM 12 BR	NH 12 BR	NL 12 S
B 12	F 16	FL 12	FM 7	NH 12	
B 12 B	F 7 USA	FL 6	FS 7	NL 10 AUS	OLYMPIAN MKII
B 7 L	FH 12 BR	FL 616-619	N 10	NL 10 BR	
B 7 L DD	FH 12	FL 7	N 10 USA	NL 10 S	SUPEROLYMPIAN



Sampa Nr.

030.511

O.E.M. Nr.

3090 267
(270 911)
(271 141)

Dimension

M33xø37/ø48x237

Description

King Pin Set, Without Bearing Single



Sampa Nr.

030.511/1

O.E.M. Nr.

3090 267 S
(270 911 S)
(271 141 S)

Dimension

M33xø37/ø48x237

Description

King Pin Set, Without Bearing Double



Sampa Nr.

030.511/2

O.E.M. Nr.

3090 267 S1
(270 911 S1)
(271 141 S1)

Dimension

M33xø37/ø48x237

Description

King Pin Set, With Bearing Single



Sampa Nr.

030.511/3

O.E.M. Nr.

3090 267 S2
(270 911 S2)
(271 141 S2)

Dimension

M33xø37/ø48x237

Description

King Pin Set, With Bearing Double

B 10 M BR	B 7 R BR	FE 6 USA	FS 7	NL 10 BR
B 10 R BR	B 7 R	FL 10	N 10	NL 10 S
B 12 BR	F 10	FL 12	N 10 USA	NL 12 AUS
B 58 BR	F 12	FL 6	N 12	NL 12 BR
B 7	F 16	FL 616-619	N 12 USA	NL 12 S
B 7 F	F 7 USA	FL 7	NL 10 AUS	

Sampa Nr.

030.513

O.E.M. Nr.

276 193



Dimension
M30xø35/ø45x221

Description

King Pin Set, Without Bearing Single

Sampa Nr.

030.513/1

O.E.M. Nr.

276 193 S



Dimension
M30xø35/ø45x221

Description

King Pin Set, Without Bearing Double

Sampa Nr.

030.513/2

O.E.M. Nr.

276 193 S1



Dimension
M30xø35/ø45x221

Description

King Pin Set, With Bearing Single

Sampa Nr.

030.513/3

O.E.M. Nr.

276 193 S2



Dimension
M30xø35/ø45x221

Description

King Pin Set, With Bearing Double

B 6	FE 7 USA
B 6 BLE	FL 6
FE 6 USA	FL 608-615

Sampa Nr.

030.558

O.E.M. Nr.

3093 731



Dimension
M40x1.5/ø60x232

Description

King Pin Set

B 12	FM 10
B 12 B	FM 12
B 12 M	FM 7
B 7	FM 9
B 7 L	NH 12
B 7 L DD	
B 7 R	
B 9	
B 9 S	
FH 12	
FH 16	
FL 6	

Sampa Nr.

030.262

O.E.M. Nr.

2039 9428



Dimension
M93x3/ø106x31

Description

Cap for Steering Knuckle

B 12 B	FM 7
B 12 M	FM 9
B 7 L	FM 9
B 7 L DD	NH 12
B 7 R	
B 9 R	
B 9 S	
FH 12	
FH 16	
FL 6	
FM 10	
FM 12	

V-Stay - Axle Control Arm

VOLVO

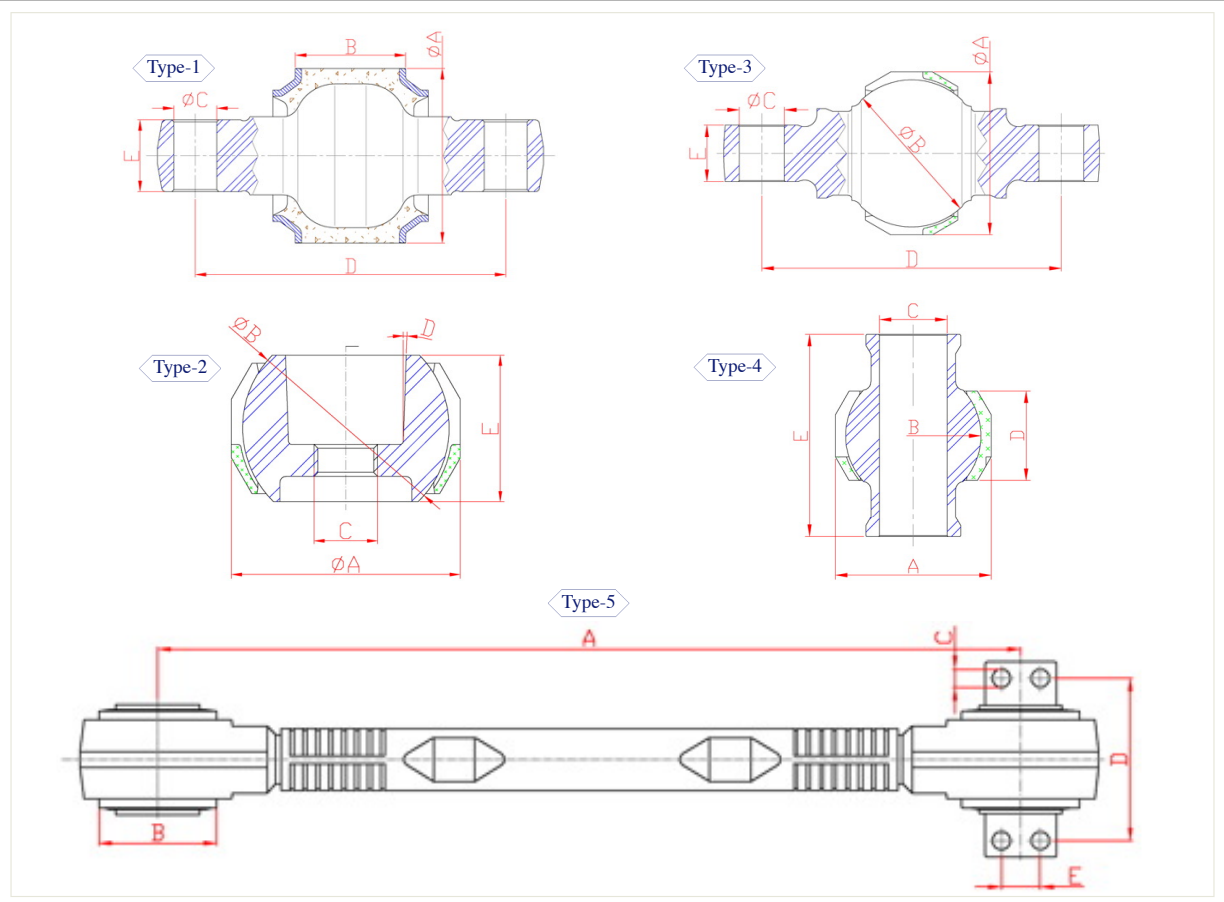

Sampa Nr.	O.E.M. Nr.	A	B	C	D	E	Repair Kit	Type
010.674	275 988	ø67	43.5	ø17	100	24		1
020.524	271 187	ø75	48	ø17	115	24		1
030.528	274 070	ø75	48	ø21	130	24		1
010.575	274 068	ø85	54	ø21	152	24		1
020.519	274 019	ø85	54	ø21	130	30		1
030.507	274 056	ø95	61	ø23	152	35		1
030.559	273 612	ø95	61	21	130	35		1
020.535	3090 015	ø46	ø40	ø20	26.5	60		4
020.512	3133 173	ø72	ø65	M20x1.5	2°52'	46		2
030.503	271 188	ø72	ø65	M20x1.5	2°52'	46		2
030.512	274 069	ø72	ø65	M20x1.5	2°52'	46		2
020.503	273 706	ø90	ø80	M24x1.5	2°52'	59		2
030.508	273 374	ø90	ø80	M24x1.5	2°52'	60		2
030.514	3090 712	ø90	ø80	M14x1.5	2°52'	60		2
020.504	273 375	ø90	ø80	ø23	152	35		3
095.239	1605 035	665	ø91.5	ø14	125	30	030.025 - 030.039	5

V-Stay - Axle Control Arm

VOLVO



Sampa Nr.

030.025

O.E.M. Nr.

1135 080

Dimension

ø52xø91.3x85

Description

Axle Rod Mounting

B 10 M	B 9 S	FL 608-615
B 10 M BR	F 10	FL 616-619
"B 10 B, B10 BLE"	F 12	FL 7
B 10 R BR	F 16	FM 10
B 12	FH 12	FM 12
B 12 BR	FH 12 BR	FM 7
B 12 M	FH 12 J	FS 7
B 12 M	FH 16	NH 12
B 58 BR	FL 10	NH 12 BR
B 7 R	FL 12	
B 7 R BR	FL 6	

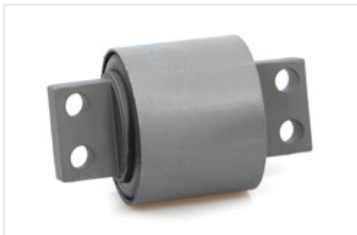

Sampa Nr.

030.038

O.E.M. Nr.

1614 355

Dimension

ø91.5x150 / Max 55 ShA

Description

Axle Rod Mounting

B 10 L	FL 12
F 10	FL 7
F 12	FM 10
F 16	FM 12
FH 12	FM 7
FH 16	SUPEROLYMPIAN
FL 10	



Sampa Nr.

030.039

O.E.M. Nr.

1598 588

Dimension

ø91.3x150/ Max 55 ShA

Description

Axle Rod Mounting

B 10 L	F 10	FL 608-615
B 10 M	F 12	FL 616-619
B 10 M BR	F 16	FL 7
B 10 R BR	F S 7	FM 10
"B 10B, B10 BLE"	FH 12	FM 12
B 12	FH 12 BR	FM 7
B 12 BR	FH 12 J	NH 12
B 12 M	FH 16	NH 12 BR
B 58 (BR)	FL 10	NL 10 BR
B 7 R	FL 12	OLYMPIAN MKII
B 7 R BR	FL 6	SUPEROLYMPIAN



Sampa Nr.

030.040

O.E.M. Nr.

1628 107

Dimension

ø91.3x170

Description

Axle Rod Mounting

FH 12 BR	FM 12
FH 12	FM 7
FH 12 J	NH 12 BR
FH 16	NH 12
FL 6	
FM 10	

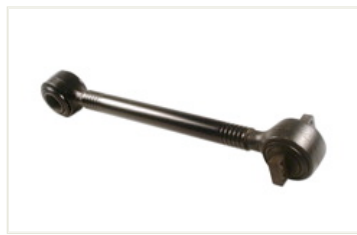

Sampa Nr.

095.239

O.E.M. Nr.

1605 035

(1082 104)

Dimension

665

Description

Tie Rod

F 10	FL 10
F 12	FL 7
F 16	



Sampa Nr.

030.044

O.E.M. Nr.

1136 891

Dimension

ø91.3x150

Description

Axle Rod Mounting

"B 10 B, B10 BLE"
B 10 M BR
B 10 M
B 10 R BR
B 12 BR
B 12

Sampa Nr.

030.037

O.E.M. Nr.

**3173 759
(1075 255)
(1591 689)**



Dimension

M16xø138.5x96

Description

Axle Rod Mounting

"B 10B, B10 BLE"	FH 12 BR	FM 10
B 10 M	FH 12	FM 12
B 12 BR	FH 12 J	FM 7
B 12	FH 16	NH 12
B 12 M	FL 10	NH 12
F 10	FL 12	NL 10 BR
F 12	FL 6	NL 12 BR
F 16	FL 7	

Sampa Nr.

030.039

O.E.M. Nr.

1598 588



Dimension

ø91.3x150 / Max 55 ShA

Description

Axle Rod Mounting

B 10 L	F 10	FL 608-615
B 10 M	F 12	FL 616-619
B 10 M BR	F 16	FL 7
B 10 R BR	F S 7	FM 10
"B 10B, B10 BLE"	FH 12	FM 12
B 12	FH 12 BR	FM 7
B 12 BR	FH 12 J	NH 12
B 12 M	FH 16	NH 12 BR
B 58 (BR)	FL 10	NL 10 BR
B 7 R	FL 12	OLYMPIAN MKII
B 7 R BR	FL 6	SUPEROLYMPIAN

Sampa Nr.

095.240

O.E.M. Nr.

**3173 294
(1628 433)**

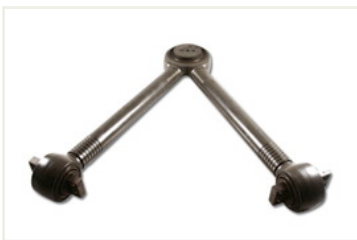

Dimension

709

Description

V-Arm

F 10	FL 12
F 12	FL 7
F 16	
FL 10	

Sampa Nr.

010.674

O.E.M. Nr.

275 988



Dimension

ø67xø17x100

Description

Rep. Kit for Axle Rod

B 6	FH 16	FM 7
B 6 BLE	FL 10	FM 9
B 7 L	FL 12	NH 12
B 7 L DD	FL 6	NH 12
F 10	FL 7	NH 12 BR
F 12	FM 10	NL 10 AUS
F 16	FM 10 BR	NL 12 AUS
FH 12	FM 12	
FH 12 BR	FM 12 BR	

Sampa Nr.

020.524

O.E.M. Nr.

271 187



Dimension

ø75xø17x115

Description

Rep. Kit for Axle Rod

F 10	FL 7	NH 12
F 12	FM 10	NH 12 BR
F 16	FM 10 BR	NL 10 AUS
FH 12	FM 12	NL 12 AUS
FH 12 BR	FM 12 BR	
FH 16	FM 7	
FL 10	FM 9	
FL 12	N 10 USA	
FL 6	N 12 USA	

Sampa Nr.

030.528

O.E.M. Nr.

274 070



Dimension

ø75xø21x130

Description

Rep. Kit for Axle Rod

F 10	FL 7	NL 12 AUS
F 12	N 10 USA	NL 12 S
F 16	N 12 USA	
FL 10	NL 10 AUS	
FL 12	NL 10 S	

V-Stay - Axle Control Arm

VOLVO



Sampa Nr.

010.575

O.E.M. Nr.

274 068

Dimension

ø85xø21x152

Description

Rep. Kit for Axle Rod

F 10	FL 7	NL 12 AUS
F 12	N 10 USA	NL 12 S
F 16	N 12 USA	
FL 10	NL 10 AUS	
FL 12	NL 10 S	



Sampa Nr.

030.507

O.E.M. Nr.

**274 056
(276 192)**

Dimension

ø95xø23x152

Description

Rep. Kit for Axle Rod

F 10	N 10	NL 12 BR
F 12	N 10 USA	
F 16	N 12	
FL 10	N 12 USA	
FL 12	NL 10 BR	



Sampa Nr.

020.519

O.E.M. Nr.

**274 019
(273 373)**

Dimension

ø85xø21x130

Description

Rep. Kit for Axle Rod

"B10 B, B 10 BLE"	FL 7	N 12 USA
F 10	FM 10	NH 12
F 12	FM 10 BR	NH 12 BR
F 16	FM 12	NL 10 AUS
FH 12	FM 12 BR	NL 10 BR
FH 12 BR	FM 7	NL 10 S
FH 16	FM 9	NL 12 AUS
FH 16 J	N 10	NL 12 BR
FL 10	N 10 USA	NL 12 S
FL 12	N 12	



Sampa Nr.

020.503

O.E.M. Nr.

**273 706
(276 191)**

Dimension

M24x1.5/ø90x59

Description

Rep. Kit for Axle Rod

F 10	N 12
F 12	N 12 USA
F 16	NL 10 BR
FL 10	NL 12 BR
FL 12	
FL 7	
N 10	
N 10 USA	



Sampa Nr.

030.559

O.E.M. Nr.

273 612

Dimension

ø95xø21/130

Description

Rep. Kit for Axle Rod

F 10	FL 7	N 12
F 12	FM 12	N 12 USA
FH 12	FM 9	NH 12
FH 16	NL 10 S	NH 12 BR
FL 10	N 10	NL 12 AUS
FL 12	N 10 USA	NL 12 S

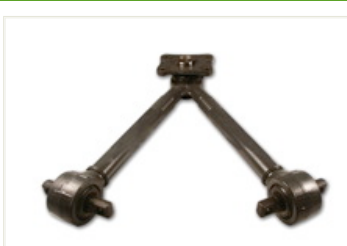

Sampa Nr.

095.231

O.E.M. Nr.

**1606 200
(1080 690)**

Dimension

636

Description

V-Arm

F 12	FL 10
F 10	F 16
N 10 USA	FL 12
N 12 USA	N 10
NL 10 BR	N 12
NL 12 BR	

V-Stay - Axle Control Arm

VOLVO

Sampa Nr.	
020.535	
O.E.M. Nr.	
3090 015	
Dimension	ø20xø46x60
Description	Rep. Kit for Axle Rod
B 6	FL 608-615
FL 6 1996	FLC

Sampa Nr.	
020.512	
O.E.M. Nr.	
3133 173	
Dimension	M20x1.5/ø72x46
Description	Rep. Kit for Axle Rod

Sampa Nr.	
030.503	
O.E.M. Nr.	
271 188	
Dimension	M20x1.5/ø72x46
Description	Rep. Kit for Axle Rod
F 10	FH 12
FH 12 BR	FH 16

Sampa Nr.		
030.512		
O.E.M. Nr.		
274 069		
Dimension	M20x1.5/ø72x46	
Description	Rep. Kit for Axle Rod	
F 10	FL 12	NL 10 AUS
F 12	FL 7	NL 10 S
F 16	N 10 USA	NL 12 AUS
FL 10	N 12 USA	NL 12 S

Sampa Nr.	
030.508	
O.E.M. Nr.	
273 374	
Dimension	M24x1.5/ø90x60
Description	Rep. Kit for Axle Rod
F 10	
N 10	
N 12	

Sampa Nr.				
030.514				
O.E.M. Nr.				
3090 712				
Dimension	M14x1.5/ø90x60			
Description	Rep. Kit for Axle Rod			
FH 12 BR	FH 16 J	FM 12	FM 9	NH12
FH 12	FM 10	FM 12 BR	NH 12	
FH 16	FM 10 BR	FM 7	NH 12 BR	

Sampa Nr.		
020.504		
O.E.M. Nr.		
273 375		
Dimension	ø90x23x152	
Description	Rep. Kit for Axle Rod	
F 12	N 12 USA	FL 12
F 10	FL 10	N 10
N 10 USA	FL 7	N 12

Sampa Nr.				
030.139				
O.E.M. Nr.				
1629 701				
Dimension	ø21xø52.5x26			
Description	Plug			
B 7 R	FH 12	FH 16	FL 616-619	NH 12
B 7 R BR	FH 12 BR	FL 6/7/10/12	FM 7/10/12	NH 12 BR
F 10/12/16	FH 12 J	FL 608-615	FS 7	

Engine - Flywheel

VOLVO



Sampa Nr.
030.085
O.E.M. Nr.
1503 490
(1503 489)

Dimension
104x148x43

Description
Engine Mounting

F 10	F 16	FL 12	N 12
F 12	F 7 USA	N 10	



Sampa Nr.
030.086
O.E.M. Nr.
1502 144
(1623 745)
(1502 352)
(1618 777)

Dimension
120x147.5x44

Description
Engine Mounting

F 10	N 10 USA
F 12	N 12
F 16	
F 7 USA	
N 10	



Sampa Nr.
030.089
O.E.M. Nr.
1611 420

Dimension
105x122x99.5

Description
Engine Mounting

N 10	NL 10 AUS	NL 12 AUS
N 10 USA	NL 10 BR	NL 12 BR
N 12	NL 10 S	NL 12 S



Sampa Nr.
030.090
O.E.M. Nr.
1607 468

Dimension
M14x62

Description
Engine Mounting

B 7 L
B 7 L DD
B 7 R BR
FL10
FL 7
FS 7



Sampa Nr.
030.092
O.E.M. Nr.
1573 891

Dimension
127x187x254

Description
Engine Mounting

F10	N10 USA	NL10 AUS	NL12 AUS
F12	N12	NL10 BR	NL12 BR
N10	N12 USA	NL10 S	NL12 S



Sampa Nr.
030.210
O.E.M. Nr.
1613 624

Dimension
133x192x139.5

Description
Engine Mounting

B 6	FL 10
B 6 BLE	FL 6
B 7 F	FL 608-615
B 7 R BR	FL 616-619
B 7R	FL 7
F 10	FS 7
F 12	
FE 7 USA	



Sampa Nr.
030.211
O.E.M. Nr.
1629 614

Dimension
260x210x156

Description
Engine Mounting

FH 12	FH 16	NH 12
FH 12 J	FH 16 J	

Sampa Nr.

030.181

O.E.M. Nr.

1696 389



Dimension

ø60

Description

Propeller Shaft Bearing

B 10 M	B 7F	FL 12	FL 7
B 10 M BR	F 10	FL 6	FS 7
B 58 BR	F12	FL 608-615	N 10
B 7	FL 10	FL 616-619	N 12

Sampa Nr.

030.182

O.E.M. Nr.

263 567



Dimension

ø70

Description

Propeller Shaft Bearing

Sampa Nr.

030.082

O.E.M. Nr.

1660 079



Dimension

149x174x68

Description

Bracket for Radiator

F 10
F 12

Sampa Nr.

030.083

O.E.M. Nr.

476 343



Dimension

148x174x64.5

Description

Bracket for Radiator

F 10
F 12

Sampa Nr.

030.145

O.E.M. Nr.

1580 440



Dimension

M10xø50x42

Description

Rubber Mounting for Exhaust

F 7 USA

Sampa Nr.

030.146

O.E.M. Nr.

**6850 149
(324 842)**



Dimension

M12xø50x42







Description

Rubber Mounting for Exhaust

"B 10 B, B 10 BLE"	B 7	FL 6
B 10 L	B 7 F	FL C
B 10 M BR	B 7 L	N 10
B 10 M	B 7 L DD	N 12
B10 R BR	B 7 R BR	NL 10 BR
B12 BR	B 7 R	NL 12 BR
B 12	F 10	VOLVO 7000
B 58 BR	F 6 USA	
B 6	F 7 USA	
B6BLE	FH 16	

Transmission

VOLVO

	<p><i>Sampa Nr.</i></p> <p>030.241</p> <p><i>O.E.M. Nr.</i></p> <p>2036 6968 (3191 939)</p>		<p><i>Sampa Nr.</i></p> <p>100.007</p> <p><i>O.E.M. Nr.</i></p> <p>1527 453</p>
<p><i>Dimension</i></p> <p>ø32xø131x96.5</p>		<p><i>Dimension</i></p> <p>M10x1/M14x1.5</p>	
<p><i>Description</i></p> <p>Ball Joint</p>		<p><i>Description</i></p> <p>Ball Joint</p>	
<p>FH 12 FH 12 BR FH 12 J FH 16 FH 16 J FH 565 FM 10</p>	<p>FM 10 BR FM 12 FM 12 BR FM 7 NH 565</p>	<p>B 10M BR B 10R BR B 7R BR B 58 BR NL 12 BR N 10</p>	<p>N 12 NL 10 BR</p>
	<p><i>Sampa Nr.</i></p> <p>040.040</p> <p><i>O.E.M. Nr.</i></p> <p>1696 684</p>		<p><i>Sampa Nr.</i></p> <p>100.008</p> <p><i>O.E.M. Nr.</i></p> <p>1190 132</p>
<p><i>Dimension</i></p> <p>M10x1.5/M12x1.75 L</p>		<p><i>Dimension</i></p> <p>M10x1.5/M12x1.75 L</p>	
<p><i>Description</i></p> <p>Ball Joint, Left</p>		<p><i>Description</i></p> <p>Ball Joint, Left</p>	
<p>B 10 M B 6 B 7 B 7R F 10 F 12 F 16</p>	<p>FH 12 FH 16 FH 16J FL 6 FL 608-615 FL 616-619 FS 7</p>	<p>B 7R B 10M BR B 10R BR B 58 BR</p>	
	<p><i>Sampa Nr.</i></p> <p>040.041</p> <p><i>O.E.M. Nr.</i></p> <p>1696 685</p>		<p><i>Sampa Nr.</i></p> <p>100.009</p> <p><i>O.E.M. Nr.</i></p> <p>1190 131</p>
<p><i>Dimension</i></p> <p>M10x1.5/M12x1.75 R</p>		<p><i>Dimension</i></p> <p>M10x1.5/M12x1.75 R</p>	
<p><i>Description</i></p> <p>Ball Joint, Right</p>		<p><i>Description</i></p> <p>Ball Joint, Right</p>	
<p>B 10 M B 6 B 7 B 7R F 10 F 12 F 16</p>	<p>FH 12 FH 16 FH 16J FL 6 FL 608-615 FL 616-619 FS 7</p>	<p>B 7R B 10M BR B 10R BR B 58 BR</p>	

Sampa Nr.
030.233

O.E.M. Nr.
382 613



Dimension
M12x1.5/M10x1.5

Description
Ball Joint

F 10
F 12
FL 10
FL 12
FL 7

Sampa Nr.
030.094

O.E.M. Nr.
**1527 234
(382 745)**



Dimension
M28x1.5/M12x1.5

Description
Ball Joint

B 10 M
B 7
B 7 F
B 7 R
F 10
F 12
F 16
F 7 USA
FE 7 USA
FL 10
FL 12
FL 6
FL 616-619
FL 7
FS 7
N 10
N 10 USA
N 12
N 12 USA
NL 10 AUS
NL 10 BR
NL 10 S
NL 12 AUS
NL 12 BR
NL 12 S

Sampa Nr.
030.079

O.E.M. Nr.
1586 316



Dimension
74x92x39

Description
Gearbox Mounting

F 10
F 12
N 10

Sampa Nr.
030.080

O.E.M. Nr.
1605 093

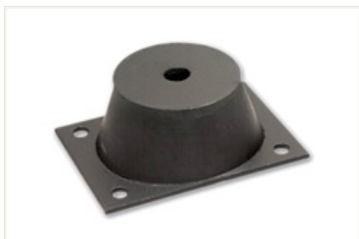

Dimension
74x103x39

Description
Gearbox Mounting

F 10
F 12
FL 10
FL 7
N 10
N 12

Sampa Nr.
030.093

O.E.M. Nr.
1614 600









Dimension
M10x54

Description
Gearbox Mounting

B 10 R BR
B 12 BR
B 12
F 10
F 12
FL 12
N 10
NL 10 AUS
NL 10 BR
NL 10 S
NL 12 AUS
NL 12 BR
NL 12 S

Shock Absorber

VOLVO

	<p><i>Sampa Nr.</i></p> <p>030.161</p>		<p><i>Sampa Nr.</i></p> <p>030.164</p>	
<p><i>Dimension</i></p> <p>530 mm. / 150 N</p>	<p><i>O.E.M. Nr.</i></p> <p>1619 106</p>	<p><i>Dimension</i></p> <p>610 mm. / 290 N</p>	<p><i>O.E.M. Nr.</i></p> <p>1083 670 (1624 101)</p>	
<p><i>Description</i></p> <p>Gas Spring</p>		<p><i>Description</i></p> <p>Gas Spring</p>		
<p>FH 12 BR FH 12 FH 12 J FH 16 FH 16 J</p>		<p>F10 F12 F16</p>		
	<p><i>Sampa Nr.</i></p> <p>030.163</p>		<p><i>Sampa Nr.</i></p> <p>030.022</p>	
<p><i>Dimension</i></p> <p>810 mm. / 550 N</p>	<p><i>O.E.M. Nr.</i></p> <p>1611 159</p>	<p><i>Dimension</i></p> <p>ø24.5xø48x25.5</p>	<p><i>O.E.M. Nr.</i></p> <p>1134 962 (308 852)</p>	
<p><i>Description</i></p> <p>Gas Spring</p>		<p><i>Description</i></p> <p>Rubber Bushing for Shock Absorber</p>		
<p>F 10 F 12 F 16 F L7</p>		<p>FE 6 USA B 12 B 58 (BR) B 7 B 7 F B6 B7L B7L DD B7R CH F 10</p>		<p>FL 10 FL 12 FL 7</p> <p>F 12 F 16 F 6 USA F 7 USA FE 6 USA FE 7 USA FL 10 FL 12 FL 6 FL 608-615</p> <p>FL 616-619 FL 7 FLC FS 7 N 10 N 12 N 12 USA N 10 USA NL 10 AUS NL 10 BR</p> <p>NL 10 S NL 12 AUS NL 12 BR NL 12 S</p>
	<p><i>Sampa Nr.</i></p> <p>030.162</p>		<p><i>Sampa Nr.</i></p> <p>030.232</p>	
<p><i>Dimension</i></p> <p>410 mm. / 170 N</p>	<p><i>O.E.M. Nr.</i></p> <p>3981 920</p>	<p><i>Dimension</i></p> <p>ø20.5xø59.5x31.5</p>	<p><i>O.E.M. Nr.</i></p> <p>1697 732</p>	
<p><i>Description</i></p> <p>Gas Spring</p>		<p><i>Description</i></p> <p>Rubber Bushing for Shock Absorber</p>		
<p>FH 12 FH 12 BR FH 12 J FH 16 FH 16 J NH 12 NH 12 NH 12 BR</p>		<p>F 10 F 12 F 16 FH 12 BR FH 12 FH 16 FL 10</p> <p>FL 12 FL 6 FL 7 FM 10 FM 10 BR FM 12 FM 12 BR</p> <p>FM 7 FM 9 NH 12 NH 12 BR NH 12 NL 10 AUS NL 10 BR</p> <p>NL 10 S NL 12 AUS NL 12 BR NL 12 S</p>		

Sampa Nr.
030.103

O.E.M. Nr.
3090 935



Dimension
ø16xø42x66

Description
Rubber Bushing for Shock Absorber

F 10	FH 16 J	FM 12 BR
F 12	FL 10	FM 7
F 16	FL 12	FM 9
FH 12	FL 7	NH 12
FH 12 BR	FM 10	NH 12 BR
FH 12 J	FM 10 BR	NL 10 AUS
FH 16	FM 12	NL 12 AUS

Sampa Nr.
030.112

O.E.M. Nr.
3090 934



Dimension
ø20xø42x50

Description
Rubber Bushing for Shock Absorber

F 10	FM 10
F 12	FM 12
FH 12	FM 7
FH 12 J	FM 9
FH 16	
FL 6	
FL 616-619	

Sampa Nr.
030.113

O.E.M. Nr.
3091 587



Dimension
ø16.2xø42x100

Description
Rubber Bushing for Shock Absorber

Sampa Nr.
030.228

O.E.M. Nr.
1698 046



Dimension
ø24.5xø40x39.5

Description
Rubber Bushing for Shock Absorber

F 10
F 12
F 16
FL 10
FL 12
FL 7

Sampa Nr.
030.229

O.E.M. Nr.
1699 143



Dimension
ø19xø50x26

Description
Rubber Bushing for Shock Absorber

F 10	NL 10 AUS
F 12	NL 10 S
F 16	NL 12 AUS
FL 10	NL 12 S
FL 12	
FL 7	

Sampa Nr.
030.230

O.E.M. Nr.
1697 731



Dimension
ø16xø42x50

Description
Rubber Bushing for Shock Absorber

B 6	FL 6
F 10	FL 608-615
F 12	FL 616-619
F 16	FL 7
FL 10	FS 7
FL 12	NL10 S

Air Suspension / Pedal

VOLVO



Sampa Nr.

030.196

O.E.M. Nr.

3950 209

Dimension

ø197x170

Description

Piston for Air Bellow

F 10	FL 10	FL 616-619
F 12	FL 12	FL 7
F 16	FL 6	FS 7
FH 16	FL 608-615	



Sampa Nr.

030.266

O.E.M. Nr.

**2045 6152 S
(6608 N P01 S)**

Dimension

ø168x182

Description

Piston for Air Bellow



Sampa Nr.

030.152

O.E.M. Nr.

1134 566

Dimension

ø85x75

Description

Rubber Buffer

"B 10 B, B 10 BLE"	B7L	FL 6
B 10 L	B 7 L DD	FL 608-615
B 10 M BR	B 7 R BR	FL 616-619
B 10 M	B 7 R	FL 7
B 10R BR	F 10	FLC
B 12 BR	F 12	FM 10
B 12	F 16	FM 12
B 12 B	FH 12	FM 7
B 12 M	FH 12 J	FM 9
B 58 BR	FH 16	FS 7
B 6	FL 10	
B 6 BLE	FL 12	



Sampa Nr.

030.267

O.E.M. Nr.

**2045 6156 S
(6607 N P01 S)**

Dimension

ø168x168

Description

Piston for Air Bellow



Sampa Nr.

030.268

O.E.M. Nr.

**2045 6150 S
(6605 N P01 S)**

Dimension

ø200x182

Description

Piston for Air Bellow



Sampa Nr.

030.250

O.E.M. Nr.

**1586 076
(1587 262)**

Dimension

ø15x110

Description

Return Spring

B 6	F 12	N 10 USA
B 6 BLE	F 16	N 12
B 7	FE 7 USA	N 12 USA
B 7 F	FS 7	NL 10 AUS
F 10	N 10	NL 12 AUS



Sampa Nr.

030.269

O.E.M. Nr.

**2045 6154 S
(6606 N P01 S)**

Dimension

ø198x169

Description

Piston for Air Bellow