

# Spare Parts for European Trucks & Trailers



# 7

## R.V.I.

"technology, reliability & quality..."



[www.sampalkw.com](http://www.sampalkw.com)



"technology, reliability & quality..."

[www.sampalkw.com](http://www.sampalkw.com)

**Sampa Nr.**

**080.032**

**O.E.M. Nr.**

**5010 060 127**



**Dimension**

ø20xø44.5x104

**Description**

Spring Bushing

G260/290  
G210/230  
G320  
AE380/385TI/420TI/500/520  
MAXTER 6X4 8X4  
G230/270 SP  
G220/270 BOM  
G200/210/230TI  
"G" MANAGER 4X2"  
"G" MANAGER 6X2 & 6X4"  
G340TI 6X6  
G340TI 4X4  
G340TI TR 18T  
PREMIUM TR 4X2 ==>1999  
PREMIUM 6X2&6X2/4 ==>1999  
MAXTER 4X2-4X4  
AE MAGNUM390/420TI/430/470/560  
PREMIUM PR 4X2 ==> 1999  
KERAX ==> 1999  
PREMIUM 260 SP  
PG230/280  
MAGNUM E-TECH 400/440/480  
PREMIUM TR 4X2 2000 ==>  
PREMIUM(FAB22E/H/J/Q/R)2000==>  
PREMIUM PR 4X2 (FAB22A)2000==>  
KERAX FAB 33A==>S 2000==>2002  
PREMIUM TRACTEUR 4X2(FAB 22CC)  
PREMIUM(FAB22EE/HA/HB/JJ/QQ/RR)  
PREMIUM PR 4X2 (FAB 22AA/AB)  
KERAX (FAB 33AA/././SS)  
KERAX (FAB33A/././R) 2003==>  
PREMIUM 22C 071 ==> 1999  
KERAX 33G ARMEE BANGLADESH  
KERAX 33K ARMEE BANGLADESH

**Sampa Nr.**

**080.573**

**O.E.M. Nr.**

**5010 060 127 S**



**Dimension**

ø20xø44.5x104

**Description**

Rep. Kit Spring Bolt Assembly

G340TI TR 18T PREMIUM PR 4X2 (FAB22A)2000==>  
PREMIUM TR 4X2 ==>1999 PREMIUM TRACTEUR 4X2(FAB 22CC)  
PREMIUM 6X2&6X2/4 ==>1999 PREMIUM PR 4X2 ==> 1999  
PREMIUM 260 SP PREMIUM(FAB22EE/HA/HB/JJ/QQ/RR)  
MAGNUM E-TECH 400/440/480 PREMIUM PR 4X2 (FAB 22AA/AB)  
PREMIUM TR 4X2 2000 ==> PREMIUM TR 4X2 (FAB22A)2000==>  
PREMIUM(FAB22E/H/J/Q/R)2000==> PREMIUM 22C 071 ==> 1999

**Sampa Nr.**

**080.574**

**O.E.M. Nr.**

**5010 060 127 S1**



**Dimension**

ø20xø44.5x104

**Description**

Rep. Kit Spring Bolt Assembly

G260/290  
G210/230  
G320  
AE380/385TI/420TI/500/520  
MAXTER 6X4 8X4  
G230/270 SP  
G220/270 BOM  
G200/210/230TI  
"G" MANAGER 4X2"  
"G" MANAGER 6X2 & 6X4"  
G340TI 6X6  
G340TI 4X4  
G340TI TR 18T  
PREMIUM TR 4X2 ==>1999  
PREMIUM 6X2&6X2/4 ==>1999  
MAXTER 4X2-4X4  
AE MAGNUM390/420TI/430/470/560  
PREMIUM PR 4X2 ==> 1999  
KERAX ==> 1999  
PREMIUM 260 SP  
PG230/280  
MAGNUM E-TECH 400/440/480  
PREMIUM TR 4X2 2000 ==>  
PREMIUM(FAB22E/H/J/Q/R)2000==>  
PREMIUM PR 4X2 (FAB22A)2000==>  
KERAX FAB 33A==>S 2000==>2002  
PREMIUM TRACTEUR 4X2(FAB 22CC)  
PREMIUM(FAB22EE/HA/HB/JJ/QQ/RR)  
PREMIUM PR 4X2 (FAB 22AA/AB)  
KERAX (FAB 33AA/././SS)  
KERAX (FAB33A/././R) 2003==>  
PREMIUM 22C 071 ==> 1999  
KERAX 33G ARMEE BANGLADESH  
KERAX 33K ARMEE BANGLADESH

**Sampa Nr.**

**080.576**

**O.E.M. Nr.**

**5010 060 127 S2**



**Dimension**

ø20xø44.5x104

**Description**

Rep. Kit Spring Bolt Assembly

G340TI TR 18T PREMIUM(FAB22E/H/J/Q/R)2000==>  
PREMIUM TR 4X2 ==>1999 PREMIUM PR 4X2 (FAB22A)2000==>  
PREMIUM 6X2&6X2/4 ==>1999 MIDLUM 42B3/4-44TA/C.-45D/E.  
PREMIUM PR 4X2 ==> 1999 PREMIUM TRACTEUR 4X2(FAB 22CC)  
PREMIUM 260 SP PREMIUM(FAB22EE/HA/HB/JJ/QQ/RR)  
MAGNUM E-TECH 400/440/480 PREMIUM PR 4X2 (FAB 22AA/AB)  
PREMIUM TR 4X2 2000 ==> PREMIUM 22C 071 ==> 1999

## Spring Suspension



Sampa Nr.

**080.092**

O.E.M. Nr.

5001 852 218

Dimension

ø30xø70x104

Description

Rubber Bushing for Spring

AE380/385TI/420TI/500/520  
G340TI TR 18T  
PREMIUM TR 4X2 ==>1999  
PREMIUM 6X2&6X2/4 ==>1999  
AE MAGNUM390/420TI/430/470/560  
PREMIUM PR 4X2 ==> 1999

KERAX ==> 1999  
MAGNUM E-TECH 400/440/480  
PREMIUM TR 4X2 2000 ==>  
PREMIUM(FAB22E/H/J/Q/R)2000==>  
PREMIUM PR 4X2 (FAB22A)2000==>  
KERAX FAB 33A==>S 2000==>2002

MIDLUM 42B3/4-44T/V/C.-45D./E.  
PREMIUM TRACTEUR 4X2(FAB 22CC)  
PREMIUM(FAB22EE/HA/HB/JJ/QQ/RR  
PREMIUM PR 4X2 (FAB 22AA/AB)  
KERAX (FAB 33AA.././SS)  
PREMIUM 22C 071 ==> 1999



Sampa Nr.

**080.559**

O.E.M. Nr.

5001 852 218 S

Dimension

ø30xø70x104

Description

Rep. Kit Spring Bolt Assembly



Sampa Nr.

**075.020**

O.E.M. Nr.

5000 815 738

Dimension

ø30xø68x104

Description

Rubber Bushing for Spring

G260/290  
R370/390/420 —>1989  
R310/330/340/365 1984—>

AE380/385TI/420TI/500/520  
"R" 1990—>1992"  
"R" 1993—>"

"G" MANAGER 4X2"  
"G" MANAGER 6X2 & 6X4"  
AE MAGNUM390/420TI/430/470/560



Sampa Nr.

**080.577**

O.E.M. Nr.

5000 815 738 S

Dimension

ø30xø68x104

Description

Rep. Kit Spring Bolt Assembly



Sampa Nr.

**011.072**

O.E.M. Nr.

5010 557 698

Dimension

ø24xø62x96

Description

Rubber Bushing for Spring

MAGNUM DXI 12-VAR-12AV  
PREMIUM DXI 11-FAB-27JC/TC  
PREMIUM DXI 11-FAB-27RC/SC



Sampa Nr.

**080.120**

O.E.M. Nr.

5001 859 721

Dimension

ø24xø61.5x96.5

Description

Rubber Bushing for Spring

MAGNUM E-TECH 400/440/480  
PREMIUM TR 4X2 2000 ==>  
PREMIUM TRACTEUR 4X2(FAB 22CC)  
PREMIUM(FAB22EE/HA/HB/JJ/QQ/RR  
PREMIUM PR 4X2 (FAB 22AA/AB)  
KERAX (FAB 33AA.././SS)

Sampa Nr.

**080.181**

O.E.M. Nr.

5010 066 115



Dimension

ø21xø56.5x85

Description

Rubber Bushing for Spring

AE380/385TI/420TI/500/520  
AE MAGNUM390/420TI/430/470/560

Sampa Nr.

**080.579**

O.E.M. Nr.

5010 066 115 S



Dimension

ø21xø56.5x85

Description

Rep Kit Spring Bolt Assembly

AE380/385TI/420TI/500/520  
AE MAGNUM390/420TI/430/470/560

Sampa Nr.

**080.182**

O.E.M. Nr.

5010 066 116



Dimension

ø25xø68.5x85

Description

Rubber Bushing for Spring

AE380/385TI/420TI/500/520  
AE MAGNUM390/420TI/430/470/560

Sampa Nr.

**080.580**

O.E.M. Nr.

5010 066 116 S



Dimension

ø25xø68.5x85

Description

Rep Kit Spring Bolt Assembly

AE380/385TI/420TI/500/520  
AE MAGNUM390/420TI/430/470/560

Sampa Nr.

**080.183**

O.E.M. Nr.

5010 557 875



Dimension

ø24xø61.5x95

Description

Rubber Bushing for Spring

MAGNUM DXI 12-VAR-120AV  
PREMIUM DXI 11-FAB-27JC/TC  
PREMIUM DXI 11-FAB-27RC/SC

Sampa Nr.

**080.228**

O.E.M. Nr.

5010 630 625



Dimension

ø20xø50x96

Description

Rubber Bushing for Spring

PREMIUM DXI 11-FAB-27JC/TC  
PREMIUM DXI 11-FAB-27RC/SC  
MAGNUM DXI 12-VAR-120AV

## Spring Suspension



Sampa Nr.

**080.157**

O.E.M. Nr.

5010 130 652

Dimension

ø63.5xø111x146

Description

Rubber Bushing for Spring

MAXTER 6X4 8X4  
KERAX ==> 1999  
KERAX FAB 33A==>S 2000==>2002  
KERAX (FAB 33AAV.././SS)



Sampa Nr.

**080.158**

O.E.M. Nr.

5010 130 653

Dimension

h:140

Description

Spring Cushion

MAXTER 6X4 8X4  
KERAX ==> 1999  
KERAX FAB 33A==>S 2000==>2002  
KERAX (FAB 33AAV.././SS)



Sampa Nr.

**080.582**

O.E.M. Nr.

5010 130 652 S

Dimension

ø63.5xø111x146

Description

Rep Kit Spring Bolt Assembly

MAXTER 6X4 8X4  
KERAX ==> 1999  
KERAX FAB 33A==>S 2000==>2002  
KERAX (FAB 33AAV.././SS)



Sampa Nr.

**080.180**

O.E.M. Nr.

5010 130 654

Dimension

ø64xø75.5x70

Description

Plastic Bushing for Spring

MAXTER 6X4 8X4  
KERAX==>1999  
KERAX FAB 33A==>S 2000==>2002



Sampa Nr.

**080.583**

O.E.M. Nr.

5010 130 652 S1

Dimension

ø52.5xø63x94

Description

Rep Kit Spring Bolt Assembly

MAXTER 6X4 8X4  
KERAX ==> 1999  
KERAX FAB 33A==>S 2000==>2002  
KERAX (FAB 33AAV.././SS)



Sampa Nr.

**030.078**

O.E.M. Nr.

7420 390 836

Dimension

h:151

Description

Spring Cushion

PREMIUM 440-450  
KERAX DXI

Sampa Nr.

**080.024**

O.E.M. Nr.

5010 052 742



Dimension

ø65.5xø104.5x132.5

Description

Rubber Bushing for Spring

"R310/330/340/365 1984—>  
M140/160/200/230  
AE380/385TI/420TI/500/520  
MIDLINER GRANDE-BRETAGNE  
"R" 1990—>1992  
M/S 150/180/210/220/230TI/250  
"R" 1993—>  
G220/270 BOM  
AE MAGNUM390/420TI/430/470/560"

Sampa Nr.

**080.132**

O.E.M. Nr.

5010 052 741



Dimension

ø30xø85x127

Description

Rubber Bushing for Spring

"R310/330/340/365 1984—>  
M140/160/200/230  
AE380/385TI/420TI/500/520  
MIDLINER GRANDE-BRETAGNE  
"R" 1990—>1992  
M/S 150/180/210/220/230TI/250  
"R" 1993—>  
G220/270 BOM  
AE MAGNUM390/420TI/430/470/560"

Sampa Nr.

**080.108**

O.E.M. Nr.

5010 052 740



Dimension

M24x3/ø65x61

Description

Bushing for Spring Pin

"R310/330/340/365 1984—>  
M140/160/200/230 AE380/385TI/420TI/500/520  
MIDLINER GRANDE-BRETAGNE  
"R"1990—>1992  
M/S 150/180/210/220/230TI/250  
"R" 1993—>  
G220/270 BOM  
AE MAGNUM390/420TI/430/470/560"

Sampa Nr.

**080.555**

O.E.M. Nr.

5010 052 741 S



Dimension

ø30xø85x127

Description

Rep. Kit Spring Bolt Assembly

M140/160/200/230  
AE380/385TI/420TI/500/520  
MIDLINER GRANDE-BRETAGNE  
M/S 150/180/210/220/230TI/250  
"R" 1993—>  
G220/270 BOM  
AE MAGNUM390/420TI/430/470/560

Sampa Nr.

**080.556**

O.E.M. Nr.

5010 052 742 S



Dimension

ø65.5xø104.5x132.5

Description

Rep. Kit Spring Bolt Assembly

R310/330/340/365 1984—>  
M140/160/200/230  
AE380/385TI/420TI/500/520  
MIDLINER GRANDE-BRETAGNE  
"R" 1990—>1992  
M/S 150/180/210/220/230TI/250  
"R" 1993—>  
G220/270 BOM  
AE MAGNUM390/420TI/430/470/560

Sampa Nr.

**080.093**

O.E.M. Nr.

5010 137 848



Dimension

ø24xø61x90.5

Description

Rubber Bushing for Spring

M140/160/200/230  
AE380/385TI/420TI/500/520  
M/S 150/180/210/220/230TI/250  
G220/270 BOM  
AE MAGNUM390/420TI/430/470/560

## Spring Suspension



Sampa Nr.

**080.062**

O.E.M. Nr.

5000 448 404

Dimension

ø16xø43.5x95

Description

Rubber Bushing for Spring

M140/160/200/230  
MIDLINER GRANDE-BRETAGNE  
M/S 150/180/210/220/230TI/250  
PA200/210

MIDLUM(FAB42B1/2-43C1/2-43T/V)  
MIDLUM EXPORT (FAB 43E1-43E2)  
MIDLUM 42B3/4-44T/V/C.-45D./E.  
MIDLUM 4X4 47XA/47XC



Sampa Nr.

**080.553**

O.E.M. Nr.

5000 448 404 S

Dimension

ø16xø43.5x95

Description

Rep. Kit Spring Bolt Assembly

MIDLUM CCF 4X4 (FAB 47XF)  
MIDLUM(FAB 42US-44US-45US)



Sampa Nr.

**080.095**

O.E.M. Nr.

5000 448 405

Dimension

ø20xø54x95

Description

Rubber Bushing for Spring

M140/160/200/230  
MIDLINER GRANDE-BRETAGNE  
M/S 150/180/210/220/230TI/250  
PS150/160

PA200/210  
MIDLUM(FAB42B1/2-43C1/2-43T/V)  
MIDLUM EXPORT (FAB 43E1-43E2)  
MIDLUM 42B3/4-44T/V/C.-45D./E.



Sampa Nr.

**080.551**

O.E.M. Nr.

5000 448 405 S

Dimension

ø20xø54x95

Description

Rep. Kit Spring Bolt Assembly

MIDLUM 4X4 47XA/47XC  
MIDLUM CCF 4X4 (FAB 47XF)  
MIDLUM(FAB 42US-44US-45US)



Sampa Nr.

**080.122**

O.E.M. Nr.

5010 294 961

Dimension

ø16xø43x81

Description

Rubber Bushing for Spring

MIDLUM(FAB42B1/2-43C1/2-43TA/)  
MIDLUM 42B3/4-44TA//C.-45D./E.  
MIDLUM(FAB 42US-44US-45US)



Sampa Nr.

**080.184**

O.E.M. Nr.

5010 294 770

Dimension

ø20.5xø53.5x81

Description

Rubber Bushing for Spring

MIDLUM 42B3/4-44T/V/C.-45D./E  
MIDLUM(FAB 42US-44USI-45US)

<b>Sampa Nr.</b>	
<b>011.140</b>	
<b>O.E.M. Nr.</b>	
<b>5000 288 447</b>	
	
<b>Dimension</b>	
55x80.5x14	
<b>Description</b>	
Spring Buffer	
S110/130 (VF6JK) S100 MIDLINER GRANDE-BRETAGNE S140/160 B80/110/120 M/S 150/180/210/220/230TI/250 S120/135	S135/150 (MOT 040226) MASCOTT MASCOTT DXI

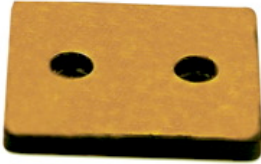
<b>Sampa Nr.</b>	
<b>030.087</b>	
<b>O.E.M. Nr.</b>	
<b>5001 832 708</b>	
	
<b>Dimension</b>	
90x100x10.5	
<b>Description</b>	
Spring Buffer	
R 1990—>1992 R 1993—> G340TI TR 18T PREMIUM TR 4X2 ==>1999 PREMIUM TR 4X2 2000 ==> PREMIUM 22C 071==> 1999	

<b>Sampa Nr.</b>	
<b>080.210</b>	
<b>O.E.M. Nr.</b>	
<b>5001 834 111</b>	
	
<b>Dimension</b>	
80x100x11	
<b>Description</b>	
Spring Buffer	
AE380/385TI/420TI/500/520 G MANAGER 4X2 AE MAGNUM390/420TI/430/470/560 KERAX==>1999 MAGNUM E-TECH 400/440/480 PREMIUM TR 4X2 2000 ==> PREMIUM TRACTEUR 4X2(FAB 22CC) KERAX (FAB 33AAV.././SS)	

<b>Sampa Nr.</b>	
<b>080.211</b>	
<b>O.E.M. Nr.</b>	
<b>5001 853 313</b>	
	
<b>Dimension</b>	
60x60x18/46	
<b>Description</b>	
Spring Buffer	
MIDLUM(FAB42B1 /2-43C1 /2-43T/V) MIDLUM 42B3/4-44T/V/C.-45D./E. MIDLUM 4X4 47XA/47XC MIDLUM CCF 4X4 (FAB 47XF) MIDLUM(FAB 42US-44US-45US)	

<b>Sampa Nr.</b>	
<b>080.212</b>	
<b>O.E.M. Nr.</b>	
<b>5001 014 359</b>	
	
<b>Dimension</b>	
66x80x18/46	
<b>Description</b>	
Spring Buffer	
M140/160/200/230 MIDLINER GRANDE-BRETAGNE M/S 150/180/210/220/230TI/250 PREMIUM PR 4X2 ==> 1999 PA200/210 PREMIUM 260 SP MIDLUM(FAB42B1 /2-43C1/2-43T/V)	PREMIUM PR 4X2 (FAB22A)2000==> MIDLUM EXPORT (FAB 43E1-43E2) MIDLUM 42B3/4-44T/V/C.-45D./E. MIDLUM 4X4 47XA/47XC PREMIUM PR 4X2 (FAB 22AA/AB) MIDLUM(FAB 42US-44US-45US)

<b>Sampa Nr.</b>	
<b>080.213</b>	
<b>O.E.M. Nr.</b>	
<b>5001 834 501</b>	
	
<b>Dimension</b>	
80x86x22/52	
<b>Description</b>	
Spring Buffer	
PREMIUM PR 4X2 = ==> 1999 PREMIUM 260 SP	

# Spring Suspension



Sampa Nr.

**080.111**

O.E.M. Nr.

**5010 383 949**

Dimension

M10/ø63.5x51.5

Description

Spring Buffer

GB131/HR15	PREMIUM 6X2&6X2/4 ==>1999
GB/TB191/231	AE MAGNUM390/420TI/430/470/560
GR191/231	PREMIUM PR 4X2 ==> 1999
GRH235/HF26	KERAX ==> 1999
G260/290	PG230/280 MAGNUM E-TECH
C260/290	400/440/480
C210/CLR220	PREMIUM TR 4X2 2000 ==>
G170	PREMIUM(FAB22E/H/J/Q/R)2000==>
G210/230	PREMIUM PR 4X2 (FAB22A)2000==>
G320	KERAX FAB 33A==>S 2000==>2002
AE380/385TI/420TI/500/520	PREMIUM TRACTEUR 4X2(FAB 22CC)
MAXTER 6X4 8X4	PREMIUM(FAB22EE/HA/HB/JJ/QQ/RR
G230/270 SP	PREMIUM PR 4X2 (FAB 22AA/AB)
G220/270 BOM	KERAX (FAB 33AA/././SS)
G200/210/230TI	MAGNUM DXI 12 -VAR-120AV
"G" MANAGER 4X2"	PREMIUM DXI 11 -FAB-27RC/SC
"G" MANAGER 6X2 & 6X4"	PREMIUM 22C 071 ==> 1999
PREMIUM TR 4X2 ==>1999	



Sampa Nr.

**080.152**

O.E.M. Nr.

**0000 777 903**

Dimension

56x81x43.5

Description

Spring Buffer

GRH/TRH305	
GRH/TRH350	
GBH/TB280 1981-->	
GBH260/280 6X6	
C260/290	
R360 6X4 --> 10/1983	
R310 6X4 JSQ 8/1984	
R370 JSQ 1984	
R370/390/420 -->1989	
R310/330/340/365 1984-->	
CBH/CLM280/340	
"R" 1990-->1992"	
C230/280/300/340TI/CCH300	
MAXTER 6X4 8X4	
CBH/CLM 320/385	
"R" 1993-->"	
G340TI 6X6	
KERAX ==> 1999	
KERAX FAB 33A==>S 2000==>2002	
KERAX (FAB 33AA/././SS)	
KERAX (FAB33A/././R) 2003==>	
KERAX 33G ARMEE BANGLADESH	
KERAX 33K ARMEE BANGLADESH	



Sampa Nr.

**080.243**

O.E.M. Nr.

**5000 745 055**

Dimension

95x120/126x77

Description

Spring Buffer

GB131/HR15	PGC191/231	G320
GB/TB191/231	GLC/GLR190/230	G230/270 SP
GC191/231	G260/290	G200/210/230TI
TF231D	G170	G MANAGER 4X2
GF151D	G210/230	



Sampa Nr.

**080.154**

O.E.M. Nr.

**0000 750 383**

Dimension

M10/106/121x66

Description

Spring Buffer

GRH235/HF26	
GRH/TRH305	
GRH/TRH350	
GBH/TB280 1981-->	
GBH260/280 6X6	
GBH260/280 6X4 -->1980	
R360 6X4 -->10/1983	
R310 6X4 JSQ 8/1984	
110-130 6X6	
R370 JSQ 1984	
R370/390/420 -->1989	
R310/330/340/365 1984-->	
CBH/CLM280/340	
"R" 1990-->1992"	
C230/280/300/340TI/CCH300	
MAXTER 6X4 8X4	
CBH/CLM 320/385	
"R" 1993-->"	
"G" MANAGER 6X2 & 6X4"	
G340TI 6X6	
KERAX ==> 1999	
KERAX(FAB33A/././S) 2000 ==>	
KERAX (FAB 33AA/././SS)	



Sampa Nr.

**080.244**

O.E.M. Nr.

**5000 745 612**

Dimension

50x126x14

Description

Spring Buffer

GB131/HR15	PGC191/231	G320
GB/TB191/231	GLC/GLR190/230	G230/270 SP
GC191/231	G260/290	G200/210/230TI
TF231D	G170	G MANAGER 4X2
GF151D	G210/230	

Sampa Nr.

**080.037**

O.E.M. Nr.

**5010 383 950**



Dimension

M12/ø79.5x121

Description

Spring Buffer

GBH/TBH280 1981—>  
 GBH260/280 6X6  
 GBH260/280 6X4 —>1980  
 GLM/TLM280  
 R370 JSQ 1984  
 R370/390/420 —>1989  
 R310/330/340/365 1984—>  
 CBH/CLM280/340  
 "R" 1990—>1992"  
 M/S 4X4 & INCENDIE  
 MAXTER 6X4 8X4  
 CBH/CLM 320/385  
 "R" 1993—>"  
 G340TI 6X6  
 MAXTER 4X2-4X4  
 KERAX ==> 1999  
 KERAX FAB 33A==>S 2000==>2002  
 KERAX (FAB 33AA././SS)  
 KERAX (FAB33A././R) 2003==>  
 KERAX 33G ARMEE BANGLADESH  
 KERAX 33K ARMEE BANGLADESH

Sampa Nr.

**080.186**

O.E.M. Nr.

**5010 294 739**



Dimension

ø17xø61x75/83.5

Description

Rubber Bushing for Spring

M/S 150/180/210/220/230TI/250  
 MIDLUM(FAB42B1 /2-43C1/2-43T/V)  
 MIDLUM 42B3/4-44TMC.-45D./E.  
 MACK MS200/250/300 1990—>  
 MACK CS200/250/300 1990—>  
 MIDLUM(FAB 42US-44US-45US)

Sampa Nr.

**080.187**

O.E.M. Nr.

**5001 862 978**



Dimension

ø35xø45x75

Description

Plastic Bushing for Spring

PREMIUM TR 4X2 ==>1999  
 PREMIUM PR 4X2 ==> 1999  
 MAGNUM E-TECH 400/440/480  
 PREMIUM(FAB22E/H/J/Q/R)2000==>  
 PREMIUM(FAB22EE/HA/HB/JJ/QQ/RR

Sampa Nr.

**080.185**

O.E.M. Nr.

**7408 079 890**



Dimension

ø21xø57.5x67

Description

Plastic Bushing for Spring

MIDLUM 42B3/4-44T/V/C.-45D./E

Sampa Nr.

**080.249**

O.E.M. Nr.

**0000 715 368**



Dimension

ø20xø79x61

Description

Spring Buffer

GR/TR280

## Spring Suspension



Sampa Nr.

**080.140**

O.E.M. Nr.

**5001 851 118**

Dimension

ø28.2xø34.2x89.3

Description

Spring Bushing

GC191/231  
GR191/231  
GRH235/HF26  
TF231D  
GF151D  
GBH/TBH280 1981—>  
PGC191/231  
GBH260/280 6X6  
GBH260/280 6X4 —>1980  
GLC/GLR190/230  
GLM/TLM280  
GLR230 4X4 SINPAR  
G170/210/230/320/260/290  
CBH/CLM280/340  
MAXTER 6X4 8X4  
CBH/CLM 320/385

G230/270 SP  
G220/270 BOM  
G200/210/230TI  
"G" MANAGER 4X2"  
"G" MANAGER 6X2 & 6X4"  
G340TI 6X6 4X4  
G340TI TR 18T  
MAXTER 4X2-4X4  
KERAX ==> 1999  
PG230/280  
KERAX FAB 33A==>S  
2000==>2002  
KERAX (FAB 33AA/././SS)  
KERAX (FAB33A/././R) 2003==>  
KERAX 33G ARMEE BANGLADESH  
KERAX 33K ARMEE BANGLADESH



Sampa Nr.

**080.142**

O.E.M. Nr.

**5010 064 632**

Dimension

ø28x146.5

Description

Spring Pin

GBH/TBH280 1981—>  
GLM/TLM280  
CBH/CLM280/340  
MAXTER 6X4 8X4  
CBH/CLM 320/385  
G340TI 6X6  
MAXTER 4X2-4X4

KERAX ==> 1999  
KERAX FAB 33A==>S  
2000==>2002  
KERAX (FAB 33AA/././SS)  
KERAX (FAB33A/././R) 2003==>  
KERAX 33G ARMEE BANGLADESH  
KERAX 33K ARMEE BANGLADESH



Sampa Nr.

**080.141**

O.E.M. Nr.

**5000 710 780**

Dimension

ø36xø44.5x89

Description

Spring Bushing

G260/290  
C260/290  
C210/CLR220  
G320  
C230/280/300/340TI/CCH300  
"G" MANAGER 4X2"

G340TI 4X4  
MAXTER 4X2-4X4  
KERAX ==> 1999  
KERAX FAB 33A==>S 2000==>2002  
KERAX (FAB 33AA/././SS)  
KERAX (FAB33A/././R) 2003==>



Sampa Nr.

**080.143**

O.E.M. Nr.

**0000 758 346**

Dimension

ø32x166

Description

Spring Pin

TR/GR305  
TR/GR350  
GR191/231  
GR/TR280  
R310 4X2 ->8/84  
R360 4X2  
GLC/GLR190/230  
GLM/TLM280  
GLR230 4X4 SINPAR  
G210/230/260/290/320  
R370 JSQ 1984  
R370/390/420 —>1989

R310/330/340/365 1984—>  
CBH/CLM280/340  
"R" 1990—>1992"  
CBH/CLM 320/385  
"R" 1993—>"  
G220/270 BOM  
G200/210/230TI  
"G" MANAGER 4X2"  
"G" MANAGER 6X2 & 6X4 "  
KERAX FAB 33A==>S 2000==>2002  
KERAX (FAB33A/././R) 2003==>



Sampa Nr.

**080.188**

O.E.M. Nr.

**5000 542 198**

Dimension

ø25xø32x70

Description

Spring Bushing

FJK/PJN/PJP  
JN55/60/85  
JK55/60/65/75  
S130/150TI (VF6JN)  
S110/130(VF6JK)  
S100  
MIDLINER GRANDE-BRETAGNE  
S140/160

M/S 150/180/210/220/230TI/250  
PS150/160  
S120/135  
S135/150 (MOT 040226)  
MIDLUM/FAB42B1 /2-43C1/2-43T/M)  
MIDLUM 42B3/4-44T/V/C.-45D/E.  
MIDLUM/FAB 42US-44US-45US)



Sampa Nr.

**020.113**

O.E.M. Nr.

**5000 286 235**

Dimension

ø25x143

Description

Spring Pin

<p><b>Sampa Nr.</b></p> <p><b>080.189</b></p> <p><b>O.E.M. Nr.</b></p> <p><b>5810 110 749</b></p>	 <p><b>Dimension</b></p> <p>ø28x216</p> <p><b>Description</b></p> <p>Spring Pin</p>	<p><b>Sampa Nr.</b></p> <p><b>080.190</b></p> <p><b>O.E.M. Nr.</b></p> <p><b>5000 703 619</b></p>	 <p><b>Dimension</b></p> <p>ø28x142</p> <p><b>Description</b></p> <p>Spring Pin</p>
<p>G260/290 G MANAGER 6X2 &amp; 6X4</p>		<p>GR191/231 TF231D GF151D GLC/GLR190/230 G260/290 G170 G210/230 G320</p>	<p>G230/270 SP G220/270 BOM G200/210/230TI G MANAGER 4X2 G MANAGER 6X2 &amp; 6X4 G340TI 4X4 PG230/280</p>
<p><b>Sampa Nr.</b></p> <p><b>080.191</b></p> <p><b>O.E.M. Nr.</b></p> <p><b>0005 000 598</b></p>	 <p><b>Dimension</b></p> <p>ø20x105.5</p> <p><b>Description</b></p> <p>Spring Pin</p>	<p><b>Sampa Nr.</b></p> <p><b>080.192</b></p> <p><b>O.E.M. Nr.</b></p> <p><b>0000 743 176</b></p>	 <p><b>Dimension</b></p> <p>ø32x153</p> <p><b>Description</b></p> <p>Spring Pin</p>
		<p>GB/TB191/231 GC191/231 GF151D PGC191/231 GLC/GLR190/230 G260/290 G170</p>	<p>G210/230 G230/270 SP G200/210/230TI G MANAGER 4X2</p>
<p><b>Sampa Nr.</b></p> <p><b>080.193</b></p> <p><b>O.E.M. Nr.</b></p> <p><b>0000 723 727</b></p>	 <p><b>Dimension</b></p> <p>ø28x132</p> <p><b>Description</b></p> <p>Spring Pin</p>	<p><b>Sampa Nr.</b></p> <p><b>080.194</b></p> <p><b>O.E.M. Nr.</b></p> <p><b>0000 796 874</b></p>	 <p><b>Dimension</b></p> <p>ø36x163</p> <p><b>Description</b></p> <p>Spring Pin</p>
<p>770KB6 SP</p>		<p>TF231D G260/290 G320 G MANAGER 4X2 G340TI 4X4</p>	

## Spring Suspension



Sampa Nr.

**080.195**

O.E.M. Nr.

0000 743 098

Dimension

ø24x142

Description

Spring Pin

GB131/HR15  
GB/TB191/231



Sampa Nr.

**080.196**

O.E.M. Nr.

5000 435 084

Dimension

ø30x149

Description

Spring Pin



Sampa Nr.

**080.197**

O.E.M. Nr.

5000 546 979

Dimension

ø25x131.5

Description

Spring Pin

PJK/PJN/PJP	S140/160
JN55/60/85	M/S 150/180/210/220/230TV/250
JK55/60/65/75	PS150/160
J&S4X4→5/1991	S120/135
S130/150TI (VF6JN)	S135/150 (MOT 040226)
S110/130(VF6JK)	MIDLUM(FAB42B1 /2-43C1/2-43TV)
S100	MIDLUM 42B3/4-44TV/C.-45D./E.
MIDLINER GRANDE-BRETAGNE	MIDLUM(FAB 42US-44US-45US)



Sampa Nr.

**080.199**

O.E.M. Nr.

5000 740 956

Dimension

ø32x160

Description

Spring Pin



Sampa Nr.

**080.200**

O.E.M. Nr.

0000 743 064

Dimension

ø22x124.5

Description

Spring Pin

GB131/HR15	110-130 6X6
GB/TB191/231	770KB6 SP



Sampa Nr.

**080.198**

O.E.M. Nr.

0000 729 137

Dimension

ø32x160

Description

Spring Pin

TR/GR305	R310 6X4 JSQ 8/1984
TR/GR350	R370 JSQ1984
GR/TR280	R370/390/420→1989
GRH/TRH305	R310/330/340/365 1984→
GRH/TRH350	R 1990→1992
R310 4X2→8/84	R 1993→
R360 4X2	G MANAGER 6X2 & 6X4
G260/290	
R360 6X4→10/1983	



Sampa Nr.

**080.201**

O.E.M. Nr.

0000 716 814

Dimension

ø28x142

Description

Spring Pin

GC191/231	G170
GR191/231	G210/230
GRH235/HF26	G320
GBH/TBH280 1981→	G230/270 SP
PGC191/231	G220/270 BOM
GBH260/280 6X6	G200/210/230TI
GBH260/280 6X4→1980	G MANAGER 4X2
GLC/GLR190/230	G MANAGER 6X2 & 6X4
G260/290	G340TI 4X4
GLM/TLM280	G340TI TR18T
GLR230 4X4 SINPAR	PG230/280

Sampa Nr.

**080.202**

O.E.M. Nr.

**5010 164 592**



Dimension

ø30x136

Description

Spring Pin

PJK/PJN/PJP	M/S 4X4 & INCENDIE
JE13/15	ME/SE/CE/160/180/210
JP11/13	PS150/160
JR/JX19/21	M210 4X4
S170 (FAB=SH)	MS300 SUDAMERICA
J&S4X4→5/1991	MIDLUM EXPORT (FAB 43E1-43E2)
S130/150TI (VF6JN)	MACK MS200/250/300 1990→
S130/150TI/170 (VF6JP)	MACK CS200/250/300 1990→
M140/160/200/230	

Sampa Nr.

**080.203**

O.E.M. Nr.

**0000 790 396**



Dimension

ø32x164

Description

Spring Pin

TR/GR305	R370/390/420→1989
TR/GR350	R310/330/340/365 1984→
GR/TR280	R 1990→1992
GRH/TRH305	R 1993→
GRH/TRH350	G MANAGER 6X2 & 6X4
R310 4X2→8/84	
R360 4X2	
R360 6X4→10/1983	
R310 6X4 JSQ 8/1984	
R370JSQ1984	

Sampa Nr.

**080.204**

O.E.M. Nr.

**0005 011 686**



Dimension

ø24x130.5

Description

Spring Pin

Sampa Nr.

**080.205**

O.E.M. Nr.

**5430 022 286**



Dimension

ø35x174.5

Description

Spring Pin

G260/290  
G MANAGER 6X2 & 6X4

Sampa Nr.

**080.206**

O.E.M. Nr.

**5000 285 345**



Dimension

ø30x162.5

Description

Spring Pin

Sampa Nr.

**080.207**

O.E.M. Nr.

**5000 745 493**



Dimension

ø30x155

Description

Spring Pin

G260/290  
G170  
G210/230  
G320  
G200/210/230TI  
G MANAGER 4X2

Sampa Nr.

**080.208**

O.E.M. Nr.

**5810 111 800**



Dimension

ø28x145

Description

Spring Pin

G MANAGER 6X2&6X4

## Spring Suspension



Sampa Nr.

080.209

O.E.M. Nr.

5430 044 067

Dimension

ø35x175

Description

Spring Pin

AE380/385TI/420TI/500/520  
 R 1993—>  
 PREMIUM TR 4X2 ==>1999  
 PREMIUM 6X2&6X2/4 ==>1999  
 AE MAGNUM390/420TI/430/470/560  
 PREMIUM PR 4X2 ==> 1999  
 MAGNUM E-TECH 400/440/480  
 PREMIUM(FAB22E/H/J/Q/R)2000==>  
 PREMIUM(FAB22EE/HA/HB/JJ/QQ/RR)



Sampa Nr.

080.146

O.E.M. Nr.

0000 466 526

Dimension

M16x2/232

Description

Spring Pin

GRH/TRH305  
 GRH/TRH350  
 GBH/TBH280 1981—>  
 GBH260/280 6X6  
 GLC/GLR190/230  
 C260/290  
 R360 6X4 —> 10/1983  
 R310 6X4 JSQ 8/1984  
 GLR230 4X4 SINPAR  
 R370 JSQ 1984  
 R370/390/420 —>1989  
 R310/330/340/365 1984—>  
 CBH/CLM280/340  
 "R" 1990—>1992"  
 C230/280/300/340TI/CCH300  
 CBH/CLM 320/385  
 "R" 1993—>"  
 MAXTER 4X2-4X4  
 KERAX ==> 1999  
 KERAX FAB 33A==>S 2000==>2002  
 KERAX (FAB 33AA/././SS)  
 KERAX (FAB33A/././R) 2003==>



Sampa Nr.

030.263

O.E.M. Nr.

7420 429 274

Dimension

Description

Cradle

PREMIUM 440-450



Sampa Nr.

030.264

O.E.M. Nr.

7420 442 252

Dimension

ø81/ø104xø154/ø173x71

Description

Bogie Suspension Bearing

PREMIUM 440-450  
 KERAX DXI



Sampa Nr.

030.265

O.E.M. Nr.

7420 466 804

Dimension

ø25xø107x74

Description

Bogie Suspension Bearing

PREMIUM 440-450  
 KERAX DXI

Sampa Nr.

**030.137**

O.E.M. Nr.

**5010 239 669**

Dimension

ø64xø68x21.5

Description

Cabin Bushing

PREMIUM PR 4X2 ==> 1999  
 KERAX ==> 1999  
 PREMIUM 260 SP  
 PREMIUM 260 SP KERAX FAB  
 33A==>S 2000==>2002  
 KERAX (FAB 33AA/././SS)  
 KERAX (FAB33A/./R) 2003==>

Sampa Nr.

**030.138**

O.E.M. Nr.

**5010 228 947**

Dimension

ø30xø68x49

Description

Cabin Mounting

PREMIUM PR 4X2 ==> 1999  
 KERAX ==> 1999  
 PREMIUM 260 SP  
 PREMIUM 260 SP KERAX FAB 33A==>S 2000==>2002  
 KERAX (FAB 33AA/././SS)  
 KERAX (FAB33A/./R) 2003==>

Sampa Nr.

**080.159**

O.E.M. Nr.

**5010 228 956**

Dimension

ø30

Description

Cabin Bracket

PREMIUM PR 4x2 ==> 2000==>2002  
 KERAX==>1999 KERAX (FAB 33AA/././SS)  
 PREMIUM 260 SP KERAX(FAB33A/./R) 2003==>  
 KERAX FAB 33A==>S KERAX 33G ARMEE BANGLADESH

Sampa Nr.

**080.578**

O.E.M. Nr.

**5010 228 947 S**

Dimension

ø30xø68x49

Description

Rep. Kit for Cabin

PREMIUM PR 4X2 ==> 1999  
 KERAX ==> 1999  
 PREMIUM 260 SP  
 PREMIUM 260 SP KERAX FAB 33A==>S 2000==>2002  
 KERAX (FAB 33AA/././SS)  
 KERAX (FAB33A/./R) 2003==>  
 KERAX 33G ARMEE BANGLADESH

Sampa Nr.

**080.112**

O.E.M. Nr.

**5001 844 625**

Dimension

ø14xø42.5x60

Description

Cabin Mounting

AE380/385TI/420TI/500/520  
 AE MAGNUM390/420TI/430/470/560  
 MAGNUM E-TECH 400/440/480

Sampa Nr.

**080.114**

O.E.M. Nr.

**5010 418 819**

Dimension

ø14xø27x45

Description

Cabin Mounting

AE380/385TI/420TI/500/520  
 AE MAGNUM390/420TI/430/470/560  
 MAGNUM E-TECH 400/440/480

Cabin



Sampa Nr.

**080.175**

O.E.M. Nr.

**5010 552 347**

Dimension

ø20xø48x42

Description

Cabin Mounting

PREMIUM DXI 11-FAB-27JC/TC  
PREMIUM DXI 11-FAB-27RC/SC



Sampa Nr.

**080.176**

O.E.M. Nr.

**5010 610 378**

Dimension

ø20.5x170

Description

Bolt for Cabin

PREMIUM DXI 11-FAB-27JC/TC  
PREMIUM DXI 11-FAB-27RC/SC



Sampa Nr.

**080.226**

O.E.M. Nr.

**5010 552 346**

Dimension

ø20xø65x55

Description

Cabin Mounting

PREMIUM DXI 11-FAB-27JC/TC  
PREMIUM DXI 11-FAB-27RC/SC



Sampa Nr.

**080.227**

O.E.M. Nr.

**5010 552 020**

Dimension

ø20.5x210

Description

Bolt for Cabin

PREMIUM DXI 11-FAB-27JC/TC  
PREMIUM DXI 11-FAB-27RC/SC



Sampa Nr.

**080.016**

O.E.M. Nr.

**5000 419 186**

Dimension

ø20xø58x81

Description

Cabin Mounting

JE13/15	M/S 4X4 & INCENDIE
G260/290	ME/SE/CE/ 160/180/210
JN55/60/85	MAXTER 6X4 8X4
JP11/13	M/S 150/180/210/220/230TI/250
JK55/60/65/75	G230/270 SP
JR/JX19/21	S120/135
S170 (FAB=SH)	G220/270 BOM
G170	G200/210/230TI
G210/230	"G" MANAGER 4X2"
S130/150TI (VF6JN)	"G" MANAGER 6X2 & 6X4"
S130/150TI/170 (VF6JP)	G340TI 6X6
J35/48/55/60	G340TI 4X4
S110/130 (VF6JK)	MAXTER 4X2-4X4
S100	S135/150 (MOT 040226)
G320	M210 4X4
M140/160/200/230	MS300 SUDAMERICA
MIDLINER GRANDE-BRETAGNE	MACK MS200/250/300 1990—>
S140/160	



Sampa Nr.

**080.119**

O.E.M. Nr.

**5010 130 430**

Dimension

ø18xø48x68.5

Description

Cabin Mounting

"R" 1993—>"

<p><i>Sampa Nr.</i></p> <p><b>080.018</b></p> <p><i>O.E.M. Nr.</i></p> <p><b>5010 273 535</b></p> <p><i>Description</i></p> <p>Cabin Mounting</p>	 <p><i>Dimension</i></p> <p>ø16.5xø50x80</p>	<p><i>Sampa Nr.</i></p> <p><b>080.019</b></p> <p><i>O.E.M. Nr.</i></p> <p><b>5010 418 820</b></p> <p><i>Description</i></p> <p>Cabin Mounting</p>	 <p><i>Dimension</i></p> <p>ø16xø38x90</p>
<p>AE380/385TI/420TI/500/520 AE MAGNUM390/420TI/430/470/560 MAGNUM E-TECH 400/440/480</p>		<p>AE380/385TI/420TI/500/520 AE MAGNUM390/420TI/430/470/560 MAGNUM E-TECH 400/440/480</p>	
<p><i>Sampa Nr.</i></p> <p><b>080.020</b></p> <p><i>O.E.M. Nr.</i></p> <p><b>5010 211 938</b></p> <p><i>Description</i></p> <p>Rubber Dust Cover for Cabin</p>	 <p><i>Dimension</i></p> <p>ø30xø46x28.5</p>	<p><i>Sampa Nr.</i></p> <p><b>080.021</b></p> <p><i>O.E.M. Nr.</i></p> <p><b>5010 211 939</b></p> <p><i>Description</i></p> <p>Cabin Mounting</p>	 <p><i>Dimension</i></p> <p>M18/38.5</p>
<p>AE380/385TI/420TI/500/520 AE MAGNUM390/420TI/430/470/560 MAGNUM E-TECH 400/440/480</p>		<p>AE380/385TI/420TI/500/520 AE MAGNUM390/420TI/430/470/560 MAGNUM E-TECH 400/440/480</p>	
<p><i>Sampa Nr.</i></p> <p><b>080.022</b></p> <p><i>O.E.M. Nr.</i></p> <p><b>5001 852 865</b></p> <p><i>Description</i></p> <p>Cabin Mounting</p>	 <p><i>Dimension</i></p> <p>ø28xø38x40</p>	<p><i>Sampa Nr.</i></p> <p><b>080.023</b></p> <p><i>O.E.M. Nr.</i></p> <p><b>5010 060 298</b></p> <p><i>Description</i></p> <p>Cabin Bushing</p>	 <p><i>Dimension</i></p> <p>ø16xø28x80</p>
<p>AE380/385TI/420TI/500/520</p>		<p>AE380/385TI/420TI/500/520</p>	

Cabin



Sampa Nr.

**080.017**

O.E.M. Nr.

**5010 316 016**

Dimension

ø25.5xø70.5x10

Description

Buffer for Cabin

PREMIUM TR 4X2 ==>1999  
 PREMIUM 6X2&6X2/4 ==>1999  
 PREMIUM PR 4X2 ==> 1999  
 KERAX ==> 1999  
 PREMIUM TR 4X2 2000 ==>  
 PREMIUM(FAB22E/H/J/Q/R)2000==>  
 PREMIUM PR 4X2 (FAB22A)2000==>  
 KERAX FAB 33A==>S 2000==>2002  
 PREMIUM TRACTEUR 4X2(FAB 22CC)

PREMIUM(FAB22EE/HA/HB/JJ/QQ/RR)  
 PREMIUM PR 4X2 (FAB 22AA/AB)  
 KERAX (FAB 33AA/././SS)  
 KERAX (FAB33A/./R) 2003==>  
 PREMIUM DXI 11 -FAB-27JC/TC  
 PREMIUM DXI 11 -FAB-27RC/SC  
 SISU  
 PREMIUM 22C 071 ==> 1999  
 KERAX 33K ARMEE BANGLADESH



Sampa Nr.

**080.043**

O.E.M. Nr.

**5010 316 015**

Dimension

ø16xø60.5x68

Description

Cabin Mounting

PREMIUM TR 4X2 ==>1999  
 PREMIUM 6X2&6X2/4 ==>1999  
 PREMIUM PR 4X2 ==> 1999  
 KERAX ==> 1999  
 PREMIUM TR 4X2 2000 ==>  
 PREMIUM(FAB22E/H/J/Q/R)2000==>  
 PREMIUM PR 4X2 (FAB22A)2000==>  
 KERAX FAB 33A==>S 2000==>2002  
 MIDLUM 42B3/4-44TA/C.-45D/E.

PREMIUM TRACTEUR 4X2(FAB 22CC)  
 PREMIUM(FAB22EE/HA/HB/JJ/QQ/RR)  
 PREMIUM PR 4X2 (FAB 22AA/AB)  
 KERAX (FAB 33AA/././SS)  
 PREMIUM DXI 11 -FAB-27JC/TC  
 PREMIUM DXI 11 -FAB-27RC/SC  
 SISU  
 PREMIUM 22C 071 ==> 1999



Sampa Nr.

**080.557**

O.E.M. Nr.

**5010 316 015 S**

Dimension

ø16xø60.5x68

Description

Rep. Kit for Cabin

PREMIUM TR 4X2 ==>1999  
 PREMIUM 6X2&6X2/4 ==>1999  
 PREMIUM PR 4X2 ==> 1999  
 KERAX ==> 1999  
 PREMIUM TR 4X2 2000 ==>  
 PREMIUM(FAB22E/H/J/Q/R)2000==>  
 PREMIUM PR 4X2 (FAB22A)2000==>

KERAX FAB 33A==>S 2000==>2002  
 PREMIUM TRACTEUR 4X2(FAB 22CC)  
 PREMIUM(FAB22EE/HA/HB/JJ/QQ/RR)  
 PREMIUM PR 4X2 (FAB 22AA/AB)  
 KERAX (FAB 33AA/././SS)  
 SISU  
 PREMIUM 22C 071 ==> 1999



Sampa Nr.

**080.053**

O.E.M. Nr.

**5010 269 380**

Dimension

ø12xø40x41.5

Description

Cabin Mounting



Sampa Nr.

**080.054**

O.E.M. Nr.

**5000 789 265**

Dimension

ø12xø40x42

Description

Cabin Mounting



Sampa Nr.

**080.554**

O.E.M. Nr.

-

Dimension

ø12xø40x42

Description

Rep. Kit for Cabin

PREMIUM TR 4X2 ==>1999  
 PREMIUM 6X2&6X2/4 ==>1999  
 PREMIUM PR 4X2 ==> 1999  
 KERAX ==> 1999  
 PREMIUM 260 SP  
 PREMIUM TR 4X2 2000 ==>  
 PREMIUM(FAB22E/H/J/Q/R)2000==>  
 PREMIUM PR 4X2 (FAB22A)2000==>  
 KERAX FAB 33A==>S 2000==>2002  
 PREMIUM TRACTEUR 4X2(FAB 22CC)  
 PREMIUM(FAB22EE/HA/HB/JJ/QQ/RR)  
 PREMIUM PR 4X2 (FAB 22AA/AB)  
 KERAX (FAB 33AA/././SS)  
 KERAX (FAB33A/./R) 2003==>  
 SISU  
 PREMIUM 22C 071 ==> 1999  
 KERAX 33G ARMEE BANGLADESH  
 KERAX 33K ARMEE BANGLADESH

*Sampa Nr.***080.109***O.E.M. Nr.***5010 228 902***Dimension*

ø28x111

*Description*

Cabin Bracket

PREMIUM TR 4X2 ==>1999  
 PREMIUM 6X2&6X2/4 ==>1999  
 PREMIUM PR 4X2 ==> 1999  
 KERAX ==> 1999  
 PREMIUM TR 4X2 2000 ==>  
 PREMIUM(FAB22E/H/J/Q/R)2000==>  
 PREMIUM PR 4X2 (FAB22A)2000==>  
 KERAX FAB 33A==>S 2000==>2002  
 PREMIUM TRACTEUR 4X2(FAB 22CC)  
 PREMIUM(FAB22EE/HA/HB/JJ/QQ/RR)  
 PREMIUM PR 4X2 (FAB 22AA/AB)  
 KERAX (FAB 33AA.././SS)  
 KERAX (FAB33A.././R) 2003==>  
 SISU  
 KERAX 33K ARMEE BANGLADESH

*Sampa Nr.***080.568***O.E.M. Nr.***5010 228 902 S***Dimension*

ø28

*Description*

Rep. Kit for Cabin

PREMIUM TR 4X2 ==>1999  
 PREMIUM 6X2&6X2/4 ==>1999  
 PREMIUM PR 4X2 ==> 1999  
 PREMIUM TR 4X2 2000 ==>  
 PREMIUM(FAB22E/H/J/Q/R)2000==>  
 PREMIUM PR 4X2 (FAB22A)2000==>  
 SISU

*Sampa Nr.***080.177***O.E.M. Nr.***5010 552 266***Dimension*

75x165x111

*Description*

Cabin Bracket

KERAX (FAB33A.././R) 2003==>  
 PREMIUM DXI 11-FAB-27JC/TC  
 PREMIUM DXI 11-FAB-27RC/SC

*Sampa Nr.***080.178***O.E.M. Nr.***5010 552 267***Dimension*

125x190x178

*Description*

Cabin Bracket

MAGNUM DXI 12-VAR-120AV

*Sampa Nr.***080.179***O.E.M. Nr.***5010 552 268***Dimension*

125x190x178

*Description*

Cabin Bracket

MAGNUM DXI 12-VAR-120AV

Cabin



Sampa Nr.

**080.238**

O.E.M. Nr.

5010 130 797  
(5010 629 414)

Dimension

ø92x125

Description

Air Bellows for Cabin

PREMIUM TR 4X2==>1999  
PREMIUM 6X2&6X2/4 ==>1999  
PREMIUM PR 4X2==> 1999  
KERAX ==> 1999  
PREMIUM TR 4X2 2000 ==>  
PREMIUM(FAB22E/H/J/Q/R)2000—>  
PREMIUM PR 4X2 (FAB22A)2000==>  
KERAX FAB 33A==>S 2000==>2002  
PREMIUM TRACTEUR 4X2(FAB 22CC)  
PREMIUM(FAB22EE/HA/HB/JJ/QQ/RR  
PREMIUM PR 4X2 (FAB 22AA/AB)  
KERAX (FAB 33AA/././SS)  
KERAX (FAB33A/././R) 2003==>  
PREMIUM DX111 -FAB-27JC/TC  
PREMIUM DXI 11 -FAB-27RC/SC  
SISU  
PREMIUM 22C 071 ==> 1999



Sampa Nr.

**080.239**

O.E.M. Nr.

5010 092 916

Dimension

ø92x115

Description

Air Bellows for Cabin

G MANAGER 4X2  
G MANAGER 6X2 & 6X4  
G340TI TR 18T



Sampa Nr.

**080.240**

O.E.M. Nr.

5010 313 619  
(5010 266 845)

Dimension

ø92x115

Description

Air Bellows for Cabin

G MANAGER 4X2  
G MANAGER 6X2 & 6X4  
G340TI TR 18T



Sampa Nr.

**080.241**

O.E.M. Nr.

5010 133 079

Dimension

ø92x93

Description

Air Bellows for Cabin

MAXTER 6X4 8X4  
G220/270 BOM  
G200/210/230TI  
G MANAGER 4X2  
G MANAGER 6X2 & 6X4  
G340TI 6X6  
G340TI 4X4  
MAXTER 4X2-4X4



Sampa Nr.

**080.063**

O.E.M. Nr.

5000 471 623

Dimension

M14/ø80x66

Description

Buffer for Cabin

GB131/HR15	JE13/15	"G" MANAGER 4X2"
GB/TB191/231	MIDLINER GRANDE-	G340TI 6X6
GC191/231	BRETAGNE	G340TI 4X4
GR191/231	MAXTER 6X4 8X4	MAXTER 4X2-4X4
GRH235/HF26	G230/270 SP	S135/150 (MOT 040226)
TF231D	G220/270 BOM	M210 4X4
GF151D	G200/210/230TI	

Sampa Nr.

**080.245**

O.E.M. Nr.

**0000 707 526**



Dimension

M10x46

Description

Buffer for Cabin

GR/TR280

Sampa Nr.

**080.246**

O.E.M. Nr.

**0000 703 308**



Dimension

ø16/ø25,5xø56x52

Description

Cabin Mounting

Sampa Nr.

**080.247**

O.E.M. Nr.

**0000 707 650**



Dimension

M8/70x80x16.5

Description

Buffer for Cabin

GR/TR280

Sampa Nr.

**080.259**

O.E.M. Nr.

-



Dimension

ø16x□ 90x54/70 ShA

Description

Cabin Mounting

Sampa Nr.

**080.258**

O.E.M. Nr.

**5000 789 681**



Dimension

ø16x□ 90x54/50 ShA

Description

Cabin Mounting

## Stabilizer



Sampa Nr.

**080.215**

O.E.M. Nr.

**5010 304 948**

## Dimension

ø42xø56x25

## Description

Stabilizer Bushing

MAXTER 6X4 8X4  
 KERAX ==> 1999  
 KERAX FAB 33A==>S 2000==>2002  
 KERAX (FAB 33AA/././SS)  
 KERAX (FAB33A/././R) 2003==>  
 KERAX 33G ARMEE BANGLADESH  
 KERAX 33K ARMEE BANGLADESH



Sampa Nr.

**080.581**

O.E.M. Nr.

**5010 304 948 S**

## Dimension

ø42xø56x25

## Description

Stabilizer Bearing Kit

MAXTER 6X4 8X4  
 KERAX ==> 1999  
 KERAX FAB 33A==>S 2000==>2002  
 KERAX (FAB 33AA/././SS)  
 KERAX (FAB33A/././R) 2003==>  
 KERAX 33G ARMEE BANGLADESH  
 KERAX 33K ARMEE BANGLADESH



Sampa Nr.

**010.039**

O.E.M. Nr.

**5010 304 950**

## Dimension

ø50.5xø86x63

## Description

Stabilizer Plastic Bearing

MAXTER 6X4 8X4  
 KERAX ==> 1999  
 KERAX FAB 33A==>S 2000==>2002  
 KERAX (FAB 33AA/././SS)  
 KERAX (FAB33A/././R) 2003==>  
 KERAX 33G ARMEE BANGLADESH  
 KERAX 33K ARMEE BANGLADESH



Sampa Nr.

**080.014**

O.E.M. Nr.

**5010 557 130**  
**(5010 557 129)**  
**(5000 434 716)**

## Dimension

ø20xø45x66

## Description

Stabilizer Rubber Bushing

M140/160/200/230  
 MIDLINER GRANDE-BRETAGNE  
 ME/SE/CE/ 160/180/210  
 M/S 150/180/210/220/230TI/250  
 PS150/160  
 PA200/210  
 MIDLUM(FAB42B1/2-43C1/2-43T/V)

MIDLUM 42B3/4-44T/V/C.-45D/E.  
 MIDLUM 4X4 47XA/47XC  
 MIDLUM CCF 4X4 (FAB 47XF)  
 MACK MS200/250/300 1990—>  
 MACK CS200/250/300 1990—>  
 MIDLUM(FAB 42US-44US-45US)



Sampa Nr.

**080.584**

O.E.M. Nr.

**5010 557 129 S**

## Dimension

ø20xø45x66

## Description

Stabilizer Bearing Kit

M140/160/200/230  
 MIDLINER GRANDE-BRETAGNE  
 ME/SE/CE/160/180/210  
 M/S 150/180/210/220/230TI/250  
 PS150/160  
 PA200/210  
 MS300 SUDAMERICA  
 MIDLUM(FAB42B1 /2-43C1 /2-43T/V)  
 MIDLUM 42B3/4-44TMC.-45D/E.  
 MIDLUM 4X4 47XA/47XC  
 MIDLUM CCF 4X4 (FAB 47XF)

MACK MS200/250/300 1990—>  
 MACK CS200/250/300 1990—>  
 MIDLUM(FAB 42US-44US-45US)  
 JE13/15  
 S170 (FAB=SH)  
 J&S4X4->5/1991  
 S130/150TI/170 (VF6JP)  
 M/S 4X4 & INCENDIE  
 M210 4X4  
 MIDLUM(FAB42B1 /2-43C112-A31N)  
 MIDLUM EXPORT (FAB 43E1-43E2)



Sampa Nr.

**080.585**

O.E.M. Nr.

**5010 557 130 S1**  
**5010 557 129 S1**  
**5000 434 716 S1**

## Dimension

ø20xø45x66

## Description

Stabilizer Bearing Kit

M140/160/200/230  
 MIDLINER GRANDE-BRETAGNE  
 ME/SE/CE/160/180/210  
 M/S 150/180/210/220/230TI/250  
 PS150/160  
 PA200/210  
 MS300 SUDAMERICA  
 MIDLUM(FAB42B1 /2-43C1 /2-43T/V)  
 MIDLUM 42B3/4-44TMC.-45D/E.  
 MIDLUM 4X4 47XA/47XC  
 MIDLUM CCF 4X4 (FAB 47XF)

MACK MS200/250/300 1990—>  
 MACK CS200/250/300 1990—>  
 MIDLUM(FAB 42US-44US-45US)  
 JE13/15  
 S170 (FAB=SH)  
 J&S4X4->5/1991  
 S130/150TI/170 (VF6JP)  
 M/S 4X4 & INCENDIE  
 M210 4X4  
 MIDLUM(FAB42B1 /2-43C112-A31N)  
 MIDLUM EXPORT (FAB 43E1-43E2)

Sampa Nr.

**080.003**

O.E.M. Nr.

**0000 790 899**



Dimension

ø43xø61x32

Description

Stabilizer Bushing

Sampa Nr.

**080.025**

O.E.M. Nr.

**0000 790 871**



Dimension

ø20xø42x67

Description

Metal Bushing for Stabilizer

Sampa Nr.

**080.532**

O.E.M. Nr.

**0000 790 899 S**



Dimension

ø43xø61x32

Description

Stabilizer Bearing Kit

TR/GR305	C230/280/300/340TI/CCH300
TR/GR350	CBH/CLM 320/385
GR191/231	"R" 1993—>
GR/TR280	G220/270 BOM
R310 4X2 ->8/84	G200/210/230TI
R360 4X2	"G" MANAGER 4X2"
GLC/GLR190/230	"G" MANAGER 6X2 & 6X4"
G260/290	G340TI 4X4
C260/290	MAXTER 4X2-4X4
GLM/TLM280	KERAX ==> 1999
GLR230 4X4 SINPAR	KERAX FAB 33A==>S
C210/CLR220	2000==>2002
G210/230	KERAX (FAB 33AA/././SS)
R370 JSQ 1984	KERAX (FAB33A/././R) 2003==>
R370/390/420 —>1989	
R310/330/340/365 1984—>	
CBH/CLM280/340	
G320	
"R" 1990—>1992"	

Sampa Nr.

**080.031**

O.E.M. Nr.

**5001 851 533 S**



Dimension

ø14xø42x21

Description

Stabilizer Bushing

PREMIUM TR 4X2  
PREMIUM 6X2&6X2/4  
AE MAGNUM390/420TI/430/470/560  
PREMIUM PR 4X2

Sampa Nr.

**080.515**

O.E.M. Nr.

**5001 851 533**



Dimension

ø14xø42x21

Description

Stabilizer Bearing Kit

PREMIUM TR 4X2  
PREMIUM 6X2&6X2/4  
AE MAGNUM390/420TI/430/470/560  
PREMIUM PR 4X2

Sampa Nr.

**080.214**

O.E.M. Nr.

**0000 487 790**



Dimension

ø28x116

Description

Stabilizer Bolt

GB131/HR15	GLC/GLR190y230
GB/TB191/231	770KB6 SP
GC191/231	
TF231D	
GF151D	
PGC191/231	

## Stabilizer



**Sampa Nr.**  
**080.001**  
**O.E.M. Nr.**  
**5000 279 225**

**Dimension**  
ø38xø58x74

**Description**  
Stabilizer Plastic Bearing



**Sampa Nr.**  
**080.002**  
**O.E.M. Nr.**  
**5000 464 786**

**Dimension**  
ø49xø63.5x76

**Description**  
Stabilizer Plastic Bearing



**Sampa Nr.**  
**080.530**  
**O.E.M. Nr.**  
-

**Dimension**

**Description**  
Stabilizer Bearing Kit



**Sampa Nr.**  
**080.531**  
**O.E.M. Nr.**  
-

**Dimension**

**Description**  
Stabilizer Bearing Kit

R310 4X2->8/84  
R360 4X2  
PJK/PJNPJP  
JE13/15  
G260/290  
C260/290  
JP11/13  
JK55/60/65/75  
JR/JX19/21  
S170 (FAB-SH)  
GLM/TLM280  
J & S 4X4 ->5/1991  
C210/CLR220  
G210/230

S130/150TI (VF6JN)  
S130/150TI/170 (VF6JP)  
R370 JSQ 1984  
R370/390/420 ->1989  
R310/330/340/365 1984->  
S110/130 (VF6JK)  
S100  
CBH/CLM280/340  
G320  
M140/160/200/230  
MIDLINER GRANDE-BRETAGNE  
"R" 1990->1992"  
S140/160  
C230/280/300/340TI/CCH300

MS 4X4 & INCENDIE  
ME/SE/CE/160/180/210  
CBH/CLM 320/385  
MS 150/180/210/220/230TI/250  
PS150/160  
"R" 1993->"  
S120/135  
G220/270 BOM  
G200/210/230TI  
"G" MANAGER 4X2"  
"G" MANAGER 6X2 & 6X4"  
G340TI 4X4  
MAXTER 4X2-4X4  
MR.C

M210 4X4  
KERAX => 1999  
PA200/210  
MS300 SUDAMERICA  
MIDLUM(FAB42B1/2-43C1/2-43T/V)  
KERAX(FAB33A//S) 2000 =>  
MIDLUM 42B3/4-44T/V/C.-45D./E.  
MIDLUM 4X4  
KERAX (FAB 33AA//SS)  
MACK MS200/250/300 1990->  
MACK GS200/250/300 1990->  
MIDLUM(FAB 42US-44US-45US)



**Sampa Nr.**  
**080.040**  
**O.E.M. Nr.**  
**5000 719 742**

**Dimension**  
ø29xø44.5x28.5

**Description**  
Stabilizer Bushing

GB131/HR15  
GB/TB191/231  
GC191/231  
PGC191/231  
G260/290  
G170  
G210/230

G320  
G230/270 SP  
G200/210/230TI  
"G" MANAGER 4X2"



**Sampa Nr.**  
**080.041**  
**O.E.M. Nr.**  
**5000 464 785**

**Dimension**  
ø54.5xø64x76

**Description**  
Stabilizer Plastic Bearing

M140/160/200/230  
M/S 150/180/210/220/230TI/250  
PA200/210  
MIDLUM(FAB42B1/2-43C1/2-43T/V)  
MIDLUM 42B3/4-44T/V/C.-45D./E.  
MIDLUM(FAB 42US-44US-45US)

Sampa Nr.

**080.001**

O.E.M. Nr.

5000 279 225



Dimension

ø38xø58x74

Description

Stabilizer Plastic Bearing

R310 4X2->8/84  
R360 4X2  
PJK/PJNPJP  
JE13/15  
G260/290  
C260/290  
JP11/13  
JK55/60/65/75  
JR/JX19/21  
S170 (FAB=SH)  
GLM/TLM280

J & S 4X4 ->5/1991  
C210/CLR220  
G210/230  
S130/150TI (VF6JN)  
S130/150TI/170 (VF6JP)  
R370 JSQ 1984  
R370/390/420 ->1989  
R310/330/340/365 1984->  
S110/130 (VF6JK)  
S100  
CBH/CLM280/340

G320  
M140/160/200/230  
MIDLINER GRANDE-BRETAGNE  
"R" 1990->1992"  
S140/160  
C230/280/300/340TI/CCH300  
MS 4X4 & INCENDIE  
ME/SE/CE/ 160/180/210  
CBH/CLM 320/385  
MS 150/180/210/220/230TI/250  
PS150/160

"R" 1993->"  
S120/135  
G220/270 BOM  
G200/210/230TI  
"G" MANAGER 4X2"  
"G" MANAGER 6X2 & 6X4"  
G340TI 4X4  
MAXTER 4X2-4X4  
MRC  
M210 4X4  
KERAX => 1999



Dimension

ø49xø63.5x76

Description

Stabilizer Plastic Bearing

PA200/210  
MS300 SUDAMERICA  
MIDLUM (FAB42B1/2-43C1/2-43TA)  
KERAX (FAB33A/././S) 2000 =>  
MIDLUM 42B3/4-44T/C.-45D/E.  
MIDLUM 4X4  
KERAX (FAB 33AA/././SS)  
MACK MS200/250/300 1990->  
MACK CS200/250/300 1990->  
MIDLUM (FAB 42US-44US-45US)

Sampa Nr.

**080.003**

O.E.M. Nr.

0000 790 899



Dimension

ø43xø61x32

Description

Stabilizer Bushing

TR/GR305  
TR/GR350  
GR191/231  
GR/VR280  
R310 4X2 ->8/84  
R360 4X2  
GLC/GLR190/230

G260/290  
C260/290  
GLM/TLM280  
GLR230 4X4 SINPAR  
C210/CLR220  
G210/230  
R370 JSQ 1984

R370/390/420 ->1989  
R310/330/340/365 1984->  
CBH/CLM280/340  
G320  
"R" 1990->1992"  
C230/280/300/340TI/CCH300  
CBH/CLM 320/385

"R" 1993->"  
G220/270 BOM  
G200/210/230TI  
"G" MANAGER 4X2"  
"G" MANAGER 6X2 & 6X4"  
G340TI 4X4  
MAXTER 4X2-4X4



Dimension

ø20xø42x67

Description

Metal Bushing for Stabilizer

KERAX => 1999  
KERAX FAB 33A=>S  
2000=>2002  
KERAX (FAB 33AA/././SS)  
KERAX (FAB33A/././R) 2003=>

Sampa Nr.

**080.528**

O.E.M. Nr.

-



Dimension

Description

Stabilizer Bearing Kit

R310 4X2->8/84  
R360 4X2  
G260/290  
C260/290  
GLM/TLM280  
C210/CLR220  
G210/230

R370 JSQ 1984  
R370/390/420 ->1989  
R310/330/340/365 1984->  
CBH/CLM280/340  
G320  
"R" 1990->1992"  
C230/280/300/340TI/CCH300

CBH/CLM 320/385  
"R" 1993->"  
G220/270 BOM  
G200/210/230TI  
"G" MANAGER 4X2"  
"G" MANAGER 6X2 & 6X4"  
G340TI 4X4

MAXTER 4X2-4X4  
KERAX => 1999  
KERAX (FAB33A/././S) 2000 =>  
KERAX (FAB 33AA/././SS)  
TYPES = R 310 - R 340 - R 357 - R 365 - R 385 - R 420

Stabilizer



Sampa Nr.

080.009

O.E.M. Nr.

0000 714 088

Dimension

ø25.5xø44.5x49.5

Description

Stabilizer Plastic Bearing

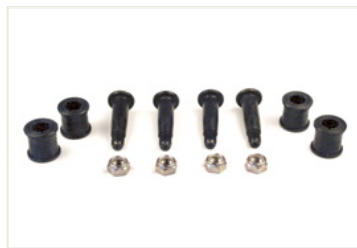

Sampa Nr.

080.534

O.E.M. Nr.

0000 714 088 S

Dimension

M20x1.5/101.5

Description

Stabilizer Bearing Kit

TR/GR305/350	R310/330/340/365 1984—>
GB131/HR15	CBH/CLM280/340
GB/TB191/231	AE380/385TI/420TI/500/520
GC191/231	""R"" 1990—>1992"
GR191/231	C230/280/300/340TI/CCH300
GRH235/HF26	MAXTER 6X4 8X4
GR/TR280	CBH/CLM 320/385
GRH/TRH305/350	""R"" 1993—>"
TF231D	G230/270 SP
GF151D	G220/270 BOM
R310/360 4X2 ->8/84	G200/210/230TI
PJK/PJN/PJP	""G"" MANAGER 4X2 & 6X2 & 6X4"
PGC191/231	G340TI 4X4
GLC/GLR190/230	MAXTER 4X2-4X4
R360 6X4 -> 10/1983	AE MAGNUM390/420TI/430/470/560
R310 6X4 JSQ 8/1984	KERAX ==> 1999
GLR230 4X4 SINPAR	PG230/280
C210/260/290 CLR220	KERAX FAB 33A==>S 2000==>2002
G170/210/230/260/290/320	KERAX (FAB 33AA/././SS)
S130/150TI (VF6JN)	KERAX (FAB33A/././R) 2003==>
R370 JSQ 1984	KERAX 33G/K ARMEE
R370/390/420 ->1989	

Sampa Nr.

080.535

O.E.M. Nr.

0000 714 088 S1

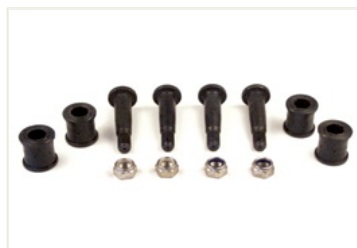

Dimension

M20x1.5/108.5

Description

Stabilizer Bearing Kit

TR/GR305	R310 4X2 ->8/84	R370/390/420 ->1989
TR/GR350	R360 4X2	R310/330/340/365 1984—>
GR/TR280	R360 6X4 -> 10/1983	"R" 1990—>1992"
GRH/TRH305	R310 6X4 JSQ 8/1984	"R" 1993—>"
GRH/TRH350	R370 JSQ 1984	



Sampa Nr.

080.156

O.E.M. Nr.

5010 130 023

Dimension

ø33.5xø67x60

Description

Stabilizer Bearing

C260/290	KERAX FAB 33A==>S
C210/CLR220	2000==>2002
CBH/CLM280/340	MIDLUM 42B3/4-44T/V/C.-45D./E.
C230/280/300/340TI/CCH300	KERAX (FAB 33AA/././SS)
MAXTER 6X4 8X4	KERAX (FAB33A/././R) 2003==>
CBH/CLM 320/385	MIDLUM(FAB 42US-44US-45US)
MAXTER 4X2-4X4	KERAX 33G ARMEE BANGLADESH
KERAX ==> 1999	KERAX 33K ARMEE BANGLADESH



Sampa Nr.

080.005

O.E.M. Nr.

5010 239 670

Dimension

ø42xø60.5x26

Description

Stabilizer Bushing

AE380/385TI/420TI/500/520	KERAX FAB 33A==>S 2000==>2002
PREMIUM TR 4X2 ==>1999	PREMIUM TRACTEUR 4X2(FAB 22CC)
PREMIUM 6X2&6X2/4 ==>1999	PREMIUM(FAB22EE/HA/HB/JJ/QQ/RR
AE MAGNUM390/420TI/430/470/560	PREMIUM PR 4X2 (FAB 22AA/AB)
PREMIUM PR 4X2 ==> 1999	KERAX (FAB 33AA/././SS)
KERAX ==> 1999	MAGNUM DXI 12 -VAR-120AV
MAGNUM E-TECH 400/440/480	PREMIUM DXI 11 -FAB-27JC/TC
PREMIUM TR 4X2 2000 ==>	PREMIUM DXI 11 -FAB-27RC/SC
PREMIUM(FAB22E/H/J/Q/R)2000==>	PREMIUM 22C 071 ==> 1999
PREMIUM PR 4X2 (FAB22A)2000==>	



Sampa Nr.

080.015

O.E.M. Nr.

5010 239 674

Dimension

ø20xø42x56.5

Description

Metal Bushing for Stabilizer

AE380/385TI/420TI/500/520	KERAX FAB 33A==>S 2000==>2002
PREMIUM TR 4X2 ==>1999	PREMIUM TRACTEUR 4X2(FAB 22CC)
PREMIUM 6X2&6X2/4 ==>1999	PREMIUM(FAB22EE/HA/HB/JJ/QQ/RR
AE MAGNUM390/420TI/430/470/560	PREMIUM PR 4X2 (FAB 22AA/AB)
PREMIUM PR 4X2 ==> 1999	KERAX (FAB 33AA/././SS)
KERAX ==> 1999	MAGNUM DXI 12 -VAR-120AV
MAGNUM E-TECH 400/440/480	PREMIUM DXI 11 -FAB-27JC/TC
PREMIUM TR 4X2 2000 ==>	PREMIUM DXI 11 -FAB-27RC/SC
PREMIUM(FAB22E/H/J/Q/R)2000==>	PREMIUM 22C 071 ==> 1999
PREMIUM PR 4X2 (FAB22A)2000==>	

Sampa Nr.

**080.009**

O.E.M. Nr.

**0000 714 088**



Dimension

ø25.5xø44.5x49.5

Description

Stabilizer Plastic Bearing

TR/GR305/350 GB131/HR15 GB/TB191/231 GC191/231 GR191/231 GRH235/HF26 GR/TR280 GRH/TRH305/350 TF231D GF151D R310/360 4X2 ->8/84 PJK/PJN/PJP PGC191/231 GLC/GLR190/230 R360 6X4 -> 10/1983 R310 6X4 JSQ 8/1984 GLR230 4X4 SINPAR C210/260/290 CLR220 G170/210/230/260/290/320 S130/150TI (VF6JN) R370 JSQ 1984 R370/390/420 ->1989 R310/330/340/365 1984-> CBH/CLM280/340	AE380/385TI/420TI/500/520 "R" 1990->1992" C230/280/300/340TI/CCH300 MAXTER 6X4 8X4 CBH/CLM 320/385 "R" 1993-> G230/270 SP G220/270 BOM G200/210/230TI "G" MANAGER 4X2 & 6X2 & 6X4" G340TI 4X4 MAXTER 4X2-4X4 AE MAGNUM390/420TI/430/470/560 KERAX ==> 1999 PG230/280 KERAX FAB 33A==>S 2000==>2002 KERAX (FAB 33AA/././SS) KERAX (FAB33A/././R) 2003==> KERAX 33G/K ARMEE
--	---

Sampa Nr.

**080.026**

O.E.M. Nr.

**0000 716 243**



Dimension

ø38x32

Description

Stabilizer Plastic Bearing

TR/GR305 TR/GR350 GR/TR280 GRH/TRH305 GRH/TRH350 R310 4X2 ->8/84 R360 4X2 R360 6X4 -> 10/1983 R310 6X4 JSQ 8/1984 R370 JSQ 1984 R370/390/420 ->1989 R310/330/340/365 1984-> "R" 1990->1992" "R" 1993->
---

Sampa Nr.

**080.521**

O.E.M. Nr.

-



Dimension

M20x1.5/101.5

Description

Stabilizer Bearing Kit

TR/GR305 TR/GR350 GR/TR280	GRH/TRH305 GRH/TRH350 R310 4X2 ->8/84	R360 4X2 R360 6X4 -> 10/1983 R310 6X4 JSQ 8/1984
----------------------------------	---	--

Sampa Nr.

**080.522**

O.E.M. Nr.

-



Dimension

M20x1.5/108.5

Description

Stabilizer Bearing Kit

R370 JSQ 1984 R370/390/420 ->1989 R310/330/340/365 1984->	"R" 1990->1992" "R" 1993->
---	-------------------------------

Sampa Nr.

**080.525**

O.E.M. Nr.

-

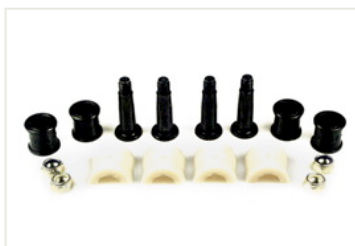

Dimension

M20x1.5/101.5

Description

Stabilizer Bearing Kit

TR/GR305 TR/GR350 GR/TR280	GRH/TRH305 GRH/TRH350 R310 4X2 ->8/84	R360 4X2 R360 6X4 -> 10/1983 R310 6X4 JSQ 8/1984
----------------------------------	---	--

Sampa Nr.

**080.526**

O.E.M. Nr.

-



Dimension

M20x1.5/108.5

Description

Stabilizer Bearing Kit

R370 JSQ 1984 R370/390/420 ->1989 R310/330/340/365 1984->	"R" 1990->1992" "R" 1993->
---	-------------------------------

Stabilizer



Sampa Nr.

080.009

O.E.M. Nr.

0000 714 088

Dimension

ø25.5xø44.5x49.5

Description

Stabilizer Plastic Bearing

TR/GR305/350  
GB131/HR15  
GB/TR191/231  
GC191/231  
GR191/231  
GRH235/HF26  
GR/TR280  
GRH/TRH305/350  
TF231D  
GF151D  
R310/360 4X2 ->8/84  
PJK/PJN/PJP  
PGC191/231  
GLC/GLR190/230  
R360 6X4 -> 10/1983  
R310 6X4 JSQ 8/1984  
GLR230 4X4 SINPAR  
C210/260/290 CLR220  
G170/210/230/260/290/320  
S130/150TI (VF6JN)  
R370 JSQ 1984  
R370/390/420 ->1989

R310/330/340/365 1984->  
CBH/CLM280/340  
AE380/385TI/420TI/500/520  
"R" 1990->1992"  
C230/280/300/340TI/CCH300  
MAXTER 6X4 8X4  
CBH/CLM 320/385  
"R" 1993->  
G230/270 SP  
G220/270 BOM  
G200/210/230TI  
"G" MANAGER 4X2 & 6X2 & 6X4"  
G340TI 4X4  
MAXTER 4X2-4X4  
AE MAGNUM390/420TI/430/470/560  
KERAX ==> 1999  
PG230/280  
KERAX FAB 33A==>S 2000==>2002  
KERAX (FAB 33AA/././SS)  
KERAX (FAB33A/././R) 2003==>  
KERAX 33G/K ARMEE



Sampa Nr.

080.027

O.E.M. Nr.

0000 716 242

Dimension

ø41x32

Description

Stabilizer Plastic Bearing

TR/GR305  
TR/GR350  
GR/TR280  
GRH/TRH305  
GRH/TRH350  
R310 4X2 ->8/84  
R360 4X2  
R360 6X4 -> 10/1983  
R310 6X4 JSQ 8/1984  
R370 JSQ 1984  
R370/390/420 ->1989  
R310/330/340/365 1984->  
"R" 1990->1992"  
"R" 1993->"



Sampa Nr.

080.519

O.E.M. Nr.

-

Dimension

M20x1.5x101.5

Description

Stabilizer Bearing Kit

TR/GR305  
TR/GR350  
GRH/TRH305

GRH/TRH350  
R310 4X2 ->8/84  
R360 4X2

R360 6X4 -> 10/1983  
R310 6X4 JSQ 8/1984  
R370 JSQ 1984

R370/390/420 ->1989  
R310/330/340/365 1984->  
"R" 1990->1992"

Sampa Nr.

080.520

O.E.M. Nr.

-

Dimension

M20x1.5/108.5

Description

Stabilizer Bearing Kit



Sampa Nr.

080.028

O.E.M. Nr.

0000 714 814

Dimension

ø34x37

Description

Stabilizer Plastic Bearing

GC191/231  
GR191/231  
GRH235/HF26  
TF231D  
GF151D

PGC191/231  
GLC/GLR190/230  
G260/290  
C260/290  
GLR230 4X4 SINPAR

C210/CLR220  
G170  
G210/230  
G320  
C230/280/300/340TI/CCH300

G230/270 SP  
G220/270 BOM  
G200/210/230TI  
"G" MANAGER 4X2"  
"G" MANAGER 6X2 & 6X4"

Sampa Nr.

080.524

O.E.M. Nr.

-

Dimension

M20x1.5/101.5

Description

Stabilizer Bearing Kit



TR/GR305  
TR/GR350  
GRH/TRH305

GRH/TRH350  
R310 4X2 ->8/84  
R360 4X2

R360 6X4 -> 10/1983  
R310 6X4 JSQ 8/1984  
R370 JSQ 1984

R370/390/420 ->1989  
R310/330/340/365 1984->  
"R" 1990->1992"

"R" 1993->"

Sampa Nr.

**080.009**

O.E.M. Nr.

**0000 714 088**



Dimension

ø25.5xø44.5x49.5

Description

Stabilizer Plastic Bearing

TR/GR305/350	R310/330/340/365 1984—>
GB131/HR15	CBH/CLM280/340
GB/TB191/231	AE380/385TI/420TI/500/520
GC191/231	"R" 1990—>1992"
GR191/231	C230/280/300/340TI/CCH300
GRH235/HF26	MAXTER 6X4 8X4
GR/TR280	CBH/CLM 320/385
GRH/TRH305/350	"R" 1993—>"
TF231D	G230/270 SP
GF151D	G220/270 BOM
R310/360 4X2 ->8/84	G200/210/230TI
PJK/PJN/PJP	"G" MANAGER 4X2 & 6X2 & 6X4"
PGC191/231	G340TI 4X4
GLC/GLR190/230	MAXTER 4X2-4X4
R360 6X4 —> 10/1983	AE MAGNUM390/420TI/430/470/560
R310 6X4 JSQ 8/1984	KERAX ==> 1999
GLR230 4X4 SINPAR	PG230/280
C210/260/290 CLR220	KERAX FAB 33A==>S 2000==>2002
G170/210/230/260/290/320	KERAX (FAB 33AA.././SS)
S130/150TI (VF6JN)	KERAX (FAB33A.././R) 2003==>
R370 JSQ 1984	KERAX 33G/K ARMEE
R370/390/420 —>1989	

Sampa Nr.

**080.030**

O.E.M. Nr.

**0000 482 176**



Dimension

M8/ø18x88

Description

Stabilizer Bracket

GB131/HR15	G210/230
GB/TB191/231	770KB6 SP
GC191/231	G320
GR191/231	C230/280/300/340TI/CCH300
GRH235/HF26	G230/270 SP
TF231D	G220/270 BOM
GF151D	G200/210/230TI
PGC191/231	"G" MANAGER 4X2"
GLC/GLR190/230	"G" MANAGER 6X2 & 6X4"
G260/290	G340TI 4X4
C260/290	PG230/280
GLR230 4X4 SINPAR	
C210/CLR220	
G170	

Sampa Nr.

**080.028**

O.E.M. Nr.

**0000 714 814**



Dimension

ø34x37

Description

Stabilizer Plastic Bearing

GC191/231	G210/230
GR191/231	G320
GRH235/HF26	C230/280/300/340TI/CCH300
TF231D	G230/270 SP
GF151D	G220/270 BOM
PGC191/231	G200/210/230TI
GLC/GLR190/230	"G" MANAGER 4X2"
G260/290	"G" MANAGER 6X2 & 6X4"
C260/290	G340TI 4X4
GLR230 4X4 SINPAR	PG230/280
C210/CLR220	GB131/HR15
G170	GB/TB191/231

Sampa Nr.

**080.029**

O.E.M. Nr.

**5010 268 225**



Dimension

M18/ø21x112.5

Description

Stabilizer Bracket

Sampa Nr.

**080.523**

O.E.M. Nr.

-



Dimension

M20x1.5/101.5

Description

Stabilizer Bearing Kit

GC191/231	G210/230
GR191/231	G320
GRH235/HF26	C230/280/300/340TI/CCH300
TF231D	G230/270 SP
GF151D	G220/270 BOM
PGC191/231	G200/210/230TI
GLC/GLR190/230	"G" MANAGER 4X2"
G260/290	"G" MANAGER 6X2 & 6X4"
C260/290	G340TI 4X4
C210/CLR220	PG230/280
G170	

Stabilizer



Sampa Nr.

**080.008**

O.E.M. Nr.

**5010 060 356**

Dimension

ø52xø90x74

Description

Stabilizer Bearing

AE380/385TI/420TI/500/520  
G340TI TR 18T  
PREMIUM TR 4X2 ==>1999  
PREMIUM 6X2&6X2/4 ==>1999  
AE MAGNUM390/420TI/430/470/560  
PREMIUM PR 4X2 ==> 1999  
KERAX ==> 1999  
PREMIUM 260 SP  
PG230/280  
MAGNUM E-TECH 400/440/480  
PREMIUM TR 4X2 2000 ==>  
PREMIUM(FAB22E/H/J/Q/R)2000==>

PREMIUM PR 4X2 (FAB22A)2000==>  
KERAX FAB 33A==>S 2000==>2002  
PREMIUM TRACTEUR 4X2(FAB 22CC)  
PREMIUM(FAB22EE/HA/HB/JJ/QQ/RR  
PREMIUM PR 4X2 (FAB 22AA/AB)  
KERAX (FAB 33AA../J/SS)  
MAGNUM DXI 12 -VAR-120AV  
PREMIUM DXI 11 -FAB-27JC/TC  
PREMIUM DXI 11 -FAB-27RC/SC  
PREMIUM 22C 071 ==> 1999



Sampa Nr.

**080.012**

O.E.M. Nr.

**5010 066 936**

Dimension

ø41x38

Description

Stabilizer Plastic Bearing

AE380/385TI/420TI/500/520  
G340TI TR 18T  
PREMIUM TR 4X2 ==>1999  
AE MAGNUM390/420TI/430/470/560  
PREMIUM PR 4X2 ==> 1999  
PREMIUM 260 SP  
PG230/280  
PREMIUM TR 4X2 2000 ==>  
PREMIUM PR 4X2 (FAB22A)2000==>  
PREMIUM TRACTEUR 4X2(FAB 22CC)  
PREMIUM PR 4X2 (FAB 22AA/AB)  
PREMIUM 22C 071 ==> 1999



Sampa Nr.

**080.013**

O.E.M. Nr.

**5010 066 937**

Dimension

ø53xø76x76

Description

Stabilizer Plastic Bearing

AE380/385TI/420TI/500/520  
G340TI TR 18T  
PREMIUM TR 4X2 ==>1999  
AE MAGNUM390/420TI/430/470/560  
PREMIUM PR 4X2 ==> 1999

PREMIUM 260 SP  
PG230/280  
PREMIUM TR 4X2 2000 ==>  
PREMIUM PR 4X2 (FAB22A)2000==>  
PREMIUM TRACTEUR 4X2(FAB 22CC)



Sampa Nr.

**080.527**

O.E.M. Nr.

-

Dimension

Description

Stabilizer Bearing Kit

PREMIUM PR 4X2 (FAB 22AA/AB)  
PREMIUM 22C 071 ==> 1999



Sampa Nr.

**080.115**

O.E.M. Nr.

**5000 391 730**

Dimension

ø30x65

Description

Stabilizer Bearing

B70  
B90  
B80/110/120



Sampa Nr.

**080.121**

O.E.M. Nr.

**5000 396 856**

Dimension

ø32xø47.5x80

Description

Stabilizer Bearing

B70  
B90  
B80/110/120  
MASCOTT

Sampa Nr.

**080.034**

O.E.M. Nr.

**5516 010 769**



Dimension

ø18xø34x54

Description

Stabilizer Rubber Bushing

PJK/PJN/PJP	S140/160
JE13/15	B80/110/120
JN55/60/85	M/S 4X4 & INCENDIE
JP11/13	ME/SE/CE/ 160/180/210
JK55/60/65/75	M/S 150/180/210/220/230TI/250
JR/JX19/21	PS150/160
S170 (FAB=SH)	S120/135
S130/150TI (VF6JN)	S135/150 (MOT 040226)
S130/150TI/170 (VF6JP)	M210 4X4
S110/130 (VF6JK)	MIDLUM 4X4 47XA/47XC
B90	MIDLUM CCF 4X4 (FAB 47XF)
S100	MACK MS200/250/300 1990—>
M140/160/200/230	MASCOTT
MIDLINER GRANDE-BRETAGNE	

Sampa Nr.

**080.036**

O.E.M. Nr.

**5000 352 492**



Dimension

ø39.5xø53.5x80

Description

Stabilizer Plastic Bearing

PJK/PJN/PJP	M140/160/200/230
JE13/15	MIDLINER GRANDE-BRETAGNE
JN55/60/85	S140/160
JP11/13	M/S 4X4 & INCENDIE
JR/JX19/21	M/S 150/180/210/220/230TI/250
S170 (FAB=SH)	PS150/160
S130/150TI (VF6JN)	S120/135
S130/150TI/170 (VF6JP)	MACK MS200/250/300 1990—>
S100	

Sampa Nr.

**080.047**

O.E.M. Nr.

**5516 031 135**



Dimension

ø40x66

Description

Stabilizer Bearing

PJK/PJN/PJP	MIDLINER GRANDE-BRETAGNE
JN55/60/85	S140/160
JP11/13	M/S 150/180/210/220/230TI/250
JR/JX19/21	PS150/160
S130/150TI (VF6JN)	S120/135
S110/130 (VF6JK)	S135/150 (MOT 040226)
S100	

Sampa Nr.

**080.044**

O.E.M. Nr.

**5010 557 313**



Dimension

ø50xø64.5x76.5

Description

Stabilizer Plastic Bearing

R310/360 4X2 ->8/84	ME/SE/CE/ 160/180/210
PJK/PJN/PJP	CBH/CLM 320/385
JE13/15	M/S 150/180/210/220/230TI/250
G210/220/230/260/290/320/270 BOM	PS150/160
C260/290 / C210/CLR220	"R" 1993—>
JP11/13	G200/210/230TI
JK55/60/65/75	"G" MANAGER 4X2 & 6X2 & 6X4"
JR/JX19/21	G340TI 4X4
S170 (FAB=SH)	MAXTER 4X2-4X4
GLM/TLM280	M210 4X4
J & S 4X4 —>5/1991	KERAX —> 1999
S130/150TI (VF6JN)/170 (VF6JP)	PA200/210
R370 JSQ 1984	MIDLUM(FAB42B1/2-43C1/2-43T/V)
R370/390/420 —>1989	KERAX FAB 33A—>S 2000—>2002
R310/330/340/365 1984—>	MIDLUM 42B3/4-44T/V/C.-45D./E.
S110/130 (VF6JK)	MIDLUM 4X4 47XA/47XC
S100/120/135/140/160	KERAX (FAB 33AA/././SS)
CBH/CLM280/340	KERAX (FAB33A/././R) 2003—>
M140/160/200/230	MIDLUM CCF 4X4 (FAB 47XF)
MIDLINER GRANDE-BRETAGNE	MACK MS200/250/300 1990—>
"R" 1990—>1992"	MACK CS200/250/300 1990—>
C230/280/300/340TI/CCH300	MIDLUM(FAB 42US-44US-45US)

Sampa Nr.

**080.035**

O.E.M. Nr.

**5516 031 136**



Dimension

ø34x59

Description

Stabilizer Bearing

PJK/PJN/PJP	B90	B80/110/120
JK55/60/65/75	S100	S120/135
S110/130 (VF6JK)	S140/160	

Sampa Nr.

**080.118**

O.E.M. Nr.

**5010 215 010**



Dimension

ø35.5x66

Description

Stabilizer Bearing

S140/160	S135/150 (MOT 040226)
B80/110/120	MASCOTT
S120/135	

## Stabilizer



Sampa Nr.

080.006

O.E.M. Nr.

5010 294 991

## Dimension

ø30xø42x19

## Description

Stabilizer Bushing

G340TI TR 18T  
 PREMIUM TR 4X2 ==>1999  
 PREMIUM 6X2&6X2/4 ==>1999

AE MAGNUM390/420TI/430/470/560  
 PREMIUM PR 4X2 ==> 1999  
 PREMIUM 260 SP



Sampa Nr.

080.007

O.E.M. Nr.

5010 130 021

## Dimension

ø38xø67x60

## Description

Stabilizer Bearing

AE380/385TI/420TI/500/520  
 "R" 1993—>"  
 G340TI TR 18T  
 PREMIUM TR 4X2 ==>1999  
 PREMIUM 6X2&6X2/4 ==>1999  
 AE MAGNUM390/420TI/430/470/560  
 PREMIUM PR 4X2 ==> 1999  
 PREMIUM 260 SP  
 PREMIUM TR 4X2 2000 ==>  
 PREMIUM(FAB22E/H/J/Q/R)2000==>  
 PREMIUM PR 4X2 (FAB22A)2000==>  
 PREMIUM TRACTEUR 4X2(FAB 22CC)  
 PREMIUM(FAB22EE/HA/HB/JJ/QQ/RR)  
 PREMIUM PR 4X2 (FAB 22AA/AB)  
 PREMIUM DXI 11 -FAB-27JC/TC  
 PREMIUM 22C 071 ==> 1999



Sampa Nr.

080.010

O.E.M. Nr.

5010 130 022

## Dimension

ø41xø67x60

## Description

Stabilizer Bearing

AE380/385TI/420TI/500/520  
 "R" 1993—>"  
 PREMIUM TR 4X2 ==>1999  
 PREMIUM 6X2&6X2/4 ==>1999  
 AE MAGNUM390/420TI/430/470/560  
 PREMIUM PR 4X2 ==> 1999  
 MAGNUM E-TECH 400/440/480  
 PREMIUM TR 4X2 2000 ==>  
 PREMIUM(FAB22E/H/J/Q/R)2000==>  
 PREMIUM PR 4X2 (FAB22A)2000==>  
 MIDLUM 42B3/4-44TA/C.-45D./E.  
 PREMIUM(FAB22EE/HA/HB/JJ/QQ/RR)  
 PREMIUM PR 4X2 (FAB 22AA/AB)  
 MAGNUM DXI 12 -VAR-120AV  
 MIDLUM(FAB 42US-44US-45US)  
 PREMIUM DXI 11 -FAB-27JC/TC  
 PREMIUM 22C 071 ==> 1999



Sampa Nr.

080.042

O.E.M. Nr.

5010 383 545

## Dimension

ø20xø51.5x41

## Description

Stabilizer Rubber Bushing

PREMIUM TR 4X2 ==>1999  
 PREMIUM 6X2&6X2/4 ==>1999  
 AE MAGNUM390/420TI/430/470/560  
 PREMIUM PR 4X2 ==> 1999  
 PREMIUM 260 SP  
 MAGNUM E-TECH 400/440/480  
 PREMIUM TR 4X2 2000 ==>  
 PREMIUM(FAB22E/H/J/Q/R)2000==>  
 PREMIUM PR 4X2 (FAB22A)2000==>  
 MIDLUM 42B3/4-44TA/C.-45D./E.  
 PREMIUM TRACTEUR 4X2(FAB 22CC)  
 PREMIUM(FAB22EE/HA/HB/JJ/QQ/RR)  
 PREMIUM PR 4X2 (FAB 22AA/AB)  
 MAGNUM DXI 12 -VAR-120AV  
 MIDLUM(FAB 42US-44US-45US)  
 PREMIUM DXI 11 -FAB-27JC/TC  
 PREMIUM DXI 11 -FAB-27RC/SC  
 PREMIUM 22C 071 ==> 1999



Sampa Nr.

080.011

O.E.M. Nr.

5010 239 135

## Dimension

ø20xø30x41

## Description

Metal Bushing for Stabilizer

G340TI TR 18T  
 PREMIUM TR 4X2 ==>1999  
 PREMIUM 6X2&6X2/4 ==>1999  
 AE MAGNUM390/420TI/430/470/560

PREMIUM PR 4X2 ==> 1999  
 PA200/210  
 PREMIUM 260 SP

<b>Sampa Nr.</b>	
<b>080.045</b>	
<b>O.E.M. Nr.</b>	
<b>5010 557 314</b>	
<b>Dimension</b>	$\varnothing 38 \times \varnothing 64.5 \times 76.5$
<b>Description</b>	Stabilizer Plastic Bearing
MIDLUM(FAB42B1/2-43C1/2-43T/V) MIDLUM EXPORT (FAB 43E1-43E2) MIDLUM 42B3/4-44T/V/C.-45D./E. MIDLUM(FAB 42US-44US-45US)	

<b>Sampa Nr.</b>	
<b>080.096</b>	
<b>O.E.M. Nr.</b>	
<b>0000 707 791</b>	
<b>Dimension</b>	$\varnothing 42.5 \times \varnothing 56 \times 69$
<b>Description</b>	Stabilizer Plastic Bearing
TR/GR305 C260/290 TR/GR350 GLR230 4X4 SINPAR GR191/231 C210/CLR220 GR/TR280 R310 4X2 ->8/84 R360 4X2 GLC/GLR190/230	

<b>Sampa Nr.</b>	
<b>080.046</b>	
<b>O.E.M. Nr.</b>	
<b>5010 557 315</b>	
<b>Dimension</b>	$\varnothing 38.5 \times \varnothing 58.5 \times 73$
<b>Description</b>	Stabilizer Plastic Bearing
R310 4X2 ->8/84 M/S 4X4 & INCENDIE R360 4X2 ME/SE/CE/ 160/180/210 PJK/PJN/PJP CBH/CLM 320/385 JE13/15 M/S 150/180/210/220/230TI/250 G260/290 PS150/160 C260/290 "R" 1993-> JP11/13 G230/270 SP JK55/60/65/75 S120/135 JR/JX19/21 G220/270 BOM S170 (FAB=SH) G200/210/230TI GLM/TLM280 "G" MANAGER 4X2" J & S 4X4 ->5/1991 "G" MANAGER 6X2 & 6X4" C210/CLR220 G340TI 4X4 G170 MAXTER 4X2-4X4 G210/230 M210 4X4 S130/150TI (VF6JN) KERAX ==> 1999 S130/150TI/170 (VF6JP) PA200/210 R370 JSQ 1984 MS300 SUDAMERICA R370/390/420 ->1989 MIDLUM(FAB42B1/2-43C1/2-43T/V) R310/330/340/365 1984-> MIDLUM EXPORT (FAB 43E1-43E2) S110/130 (VF6JK) KERAX FAB 33A==>S 2000==>2002 S100 MIDLUM 42B3/4-44TA/V.C.-45D./E. CBH/CLM280/340 MIDLUM 4X4 47XA/47XC G320 KERAX (FAB 33AA././SS) M140/160/200/230 KERAX (FAB33A././R) 2003==> MIDLINER GRANDE-BRETAGNE MIDLUM CCF 4X4 (FAB 47XF) "R" 1990->1992" MACK MS200/250/300 1990-> S140/160 MACK CS200/250/300 1990-> C230/280/300/340TI/CCH300 MIDLUM(FAB 42US-44US-45US)	

<b>Sampa Nr.</b>	
<b>080.097</b>	
<b>O.E.M. Nr.</b>	
<b>0000 707 792</b>	
<b>Dimension</b>	$\varnothing 50 \times 42.5$
<b>Description</b>	Stabilizer Plastic Bearing
TR/GR305 C260/290 TR/GR350 GLR230 4X4 SINPAR GR191/231 C210/CLR220 GR/TR280 R310 4X2 ->8/84 R360 4X2 GLC/GLR190/230	

<b>Sampa Nr.</b>	
<b>080.117</b>	
<b>O.E.M. Nr.</b>	
<b>5010 557 312</b>	
<b>Dimension</b>	$\varnothing 55 \times \varnothing 64.5 \times 76.5$
<b>Description</b>	Stabilizer Plastic Bearing
M140/160/200/230 M/S 150/180/210/220/230TI/250 PA200/210 MIDLUM(FAB42B1/2-43C1/2-43T/V) MIDLUM 42B3/4-44T/V.C.-45D./E. MIDLUM(FAB 42US-44US-45US)	

Stabilizer



Sampa Nr.

**080.048**

O.E.M. Nr.

**5010 373 300**

Dimension

ø34xø65x100

Description

Stabilizer Mounting

M/S 150/180/210/220/230TI/250  
S135/150 (MOT 040226)  
MIDLUM(FAB42B1/2-43C1/2-43T/V)  
MIDLUM 42B3/4-44T/V/C.-45D./E.  
MIDLUM(FAB 42US-44US-45US)



Sampa Nr.

**080.049**

O.E.M. Nr.

**5010 238 596**

Dimension

ø32xø65x100

Description

Stabilizer Mounting

M/S 150/180/210/220/230TI/250  
S135/150 (MOT 040226)  
MIDLUM(FAB42B1/2-43C1/2-43T/V)



Sampa Nr.

**080.110**

O.E.M. Nr.

**5000 452 655**

Dimension

ø35xø68.5x109.5

Description

Stabilizer Mounting

M140/160/200/230  
MIDLINER GRANDE-BRETAGNE  
M/S 150/180/210/220/230TI/250  
PA200/210  
MIDLUM(FAB42B1/2-43C1/2-43T/V)



Sampa Nr.

**080.113**

O.E.M. Nr.

**5430 041 078**

Dimension

ø41xø68.5x109.5

Description

Stabilizer Mounting

MIDLINER GRANDE-BRETAGNE  
M/S 150/180/210/220/230TI/250  
MIDLUM(FAB42B1/2-43C1/2-43T/V)  
MIDLUM EXPORT (FAB 43E1-43E2)  
MIDLUM 42B3/4-44T/V/C.-45D./E.  
MIDLUM(FAB 42US-44US-45US)



Sampa Nr.

**080.242**

O.E.M. Nr.

**0000 754 160**

Dimension

ø30xø45.5x31

Description

Stabilizer Bushing

TF231D  
GLC/GLR190/230

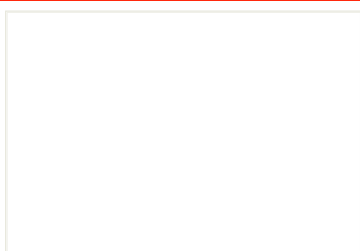

Sampa Nr.

O.E.M. Nr.

Dimension

Description

Sampa Nr.

**080.101**

O.E.M. Nr.

5000 716 656



Dimension

ø25xø50x24.5

Description

Brake Shoe Roller

Sampa Nr.

**080.104**

O.E.M. Nr.

5000 716 600



Dimension

ø25x63

Description

Brake Shoe Pin

Sampa Nr.

**080.563**

O.E.M. Nr.

-



Dimension

ø25

Description

Rep. Kit for Brake Shoe

G260/290/320	PREMIUM TR 4X2 ==>1999
C260/290	PREMIUM 6X2&6X2/4 ==>1999
C210/CLR220	MAXTER 4X2-4X4
G170	AE MAGNUM390/420TI/430/470/560
G210/230	PREMIUM PR 4X2 ==> 1999
R370/390/420 -->1989	M210 4X4
R310/330/340/365 1984-->	KERAX ==> 1999
CBH/CLM280/340	PREMIUM 260 SP
M140/160/200/230	PG230/280
AE380/385TI/420TI/500/520	MAGNUM E-TECH 400/440/480
MIDLINER GRANDE-BRETAGNE	PREMIUM TR 4X2 2000 ==>
"R" 1990 -->1992"	PREMIUM(FAB22E/H/J/Q/R)2000==>
C230/280/300/340TI/CCH300	PREMIUM PR 4X2 (FAB22A)2000==>
M/S 4X4 & INCENDIE	KERAX FAB 33A==>S 2000==>2002
ME/SE/CE/ 160/180/210	PREMIUM TRACTEUR 4X2(FAB 22CC)
MAXTER 6X4 8X4	PREMIUM(FAB22EE/HA/HB/JJ/QQ/RR
CBH/CLM 320/385	PREMIUM PR 4X2 (FAB 22AA/AB)
M/S 150/180/210/220/230TI/250	KERAX (FAB 33AA.././SS)
"R" 1993-->"	KERAX (FAB33A.././R) 2003==>
G230/270 SP	SISU
G220/270 BOM	PREMIUM 22C 071 ==> 1999
G200/210/230TI	KERAX 33G ARMEE BANGLADESH
"G" MANAGER 4X2" & 6X2 & 6X4"	KERAX 33K ARMEE BANGLADESH
G340TI 6X6 4X4	PUNCHER
G340TI TR 18T	

Sampa Nr.

**080.102**

O.E.M. Nr.

0000 189 976



Dimension

ø25xø60x20

Description

Brake Shoe Roller

Sampa Nr.

**080.107**

O.E.M. Nr.

0000 192 399



Dimension

ø25x75

Description

Brake Shoe Pin

Sampa Nr.

**080.566**

O.E.M. Nr.

5000 716 008



Dimension

ø25

Description

Rep. Kit for Brake Shoe

TR/GR305	GLR230 4X4 SINPAR
TR/GR350	C210/CLR220
GR191/231	G170
GRH235/HF26	G210/230
GR/TR280	R370 JSQ 1984
GRH/TRH305	CBH/CLM280/340
GRH/TRH350	G230/270 SP
TF231D	
R310 4X2 -->8/84	
R360 4X2	
GBH/TBH280 1981-->	
GBH260/280 6X6	
GBH260/280 6X4 -->1980	
GLC/GLR190/230	
G260/290	
C260/290	
R360 6X4 --> 10/1983	
R310 6X4 JSQ 8/1984	
GLM/TLM280	

Brake



Sampa Nr.

**080.105**

O.E.M. Nr.

5000 737 308

Dimension

ø30x110.5

Description

Brake Shoe Pin

G260/290  
C260/290  
C210/CLR220  
G170

G210/230  
R370/390/420 →1989  
R310/330/340/365 1984→  
G230/270 SP



Sampa Nr.

**080.137**

O.E.M. Nr.

5000 786 674

Dimension

ø30xø33x20

Description

Brake Shoe Bushing

TR/GR305  
TR/GR350  
GR191/231  
GRH235/HF26  
GR/TR280  
GRH/TRH305  
GRH/TRH350  
TF231D  
R310 4X2 ->8/84  
R360 4X2  
GBH/TBH280 1981→  
GBH260/280 6X6  
GBH260/280 6X4 →1980  
GLC/GLR190/230

G260/290  
C260/290  
R360 6X4 → 10/1983  
R310 6X4 JSQ 8/1984  
GLM/TLM280  
GLR230 4X4 SINPAR  
C210/CLR220  
G170  
G210/230  
R370 JSQ 1984  
R370/390/420 →1989  
R310/330/340/365 1984→  
CBH/CLM280/340  
G230/270 SP



Sampa Nr.

**080.571**

O.E.M. Nr.

-

Dimension

ø30

Description

Rep. Kit for Brake Shoe

G260/290  
C260/290  
C210/CLR220  
G170

G210/230  
R370/390/420 →1989  
R310/330/340/365 1984→  
G230/270 SP



Sampa Nr.

**080.126**

O.E.M. Nr.

5010 067 400

Dimension

ø19.5xø30x104

Description

Brake Shoe Pin



Sampa Nr.

**080.127**

O.E.M. Nr.

5010 216 613

Dimension

ø30xø33x45

Description

Brake Shoe Bushing



Sampa Nr.

**080.545**

O.E.M. Nr.

-

Dimension

ø30

Description

Rep. Kit for Brake Shoe

G170/210/230/260/290/320  
C260/290  
C210/CLR220  
R370/390/420 →1989  
R310/330/340/365 1984→  
CBH/CLM280/340  
M140/160/200/230  
AE380/385TI/420TI/500/520  
MIDLINER GRANDE-BRETAGNE  
"R" 1990→1992"  
C230/280/300/340TI/CCH300  
M/S 4X4 & INCENDIE  
ME/SE/CE/ 160/180/210  
MAXTER 6X4 8X4  
CBH/CLM 320/385  
M/S 150/180/210/220/230TI/250  
"R" 1993→"  
G230/270 SP  
G220/270 BOM  
G200/210/230TI  
"G" MANAGER 4X2"  
"G" MANAGER 6X2 & 6X4"  
G340TI 6X6 4X4  
G340TI TR 18T

PREMIUM TR 4X2 ==>1999  
PREMIUM 6X2&6X2/4 ==>1999  
MAXTER 4X2-4X4  
AE MAGNUM390/420TI/430/470/560  
PREMIUM PR 4X2 ==> 1999  
M210 4X4  
KERAX ==> 1999  
PREMIUM 260 SP  
PG230/280  
MAGNUM E-TECH 400/440/480  
PREMIUM TR 4X2 2000 ==>  
PREMIUM(FAB22E/H/J/Q/R)2000==>  
PREMIUM PR 4X2 (FAB22A)2000==>  
KERAX FAB 33A==>S 2000==>2002  
PREMIUM TRACTEUR 4X2(FAB 22CC)  
PREMIUM(FAB22EE/HA/HB/JJ/QQ/RR  
PREMIUM PR 4X2 (FAB 22AA/AB)  
KERAX (FAB 33AA/././SS)  
KERAX (FAB33A/././R) 2003==>  
SISU  
PREMIUM 22C 071 ==> 1999  
KERAX 33G ARMEE BANGLADESH  
KERAX 33K ARMEE BANGLADESH  
PUNCHER

**Sampa Nr.**  
**080.126**

**O.E.M. Nr.**  
**5010 067 400**



**Dimension**  
ø19.5xø30x104

**Description**  
Brake Shoe Pin

**Sampa Nr.**  
**080.127**

**O.E.M. Nr.**  
**5010 216 613**



**Dimension**  
ø30xø33x45

**Description**  
Brake Shoe Bushing

**Sampa Nr.**  
**080.128**

**O.E.M. Nr.**  
**5000 785 979**



**Dimension**  
ø45xø48x29.5

**Description**  
Brake Camshaft Bushing

**Sampa Nr.**  
**080.546**

**O.E.M. Nr.**  
-



**Dimension**  
ø30

**Description**  
Rep. Kit for Brake Shoe

TR/GR305/350  
GR191/231  
GRH235/HF26  
GR/TR280  
GRH/TRH305  
GRH/TRH350  
TF231D  
R310/360 4X2 ->8/84  
GBH/TBH280 1981->  
GBH260/280 6X6  
GBH260/280 6X4 ->1980  
GLC/GLR190/230  
G170/210/230/260/290/320

C260/290  
R360 6X4 -> 10/1983  
R310 6X4 JSQ 8/1984  
GLM/TLM280  
GLR230 4X4 SINPAR  
C210/CLR220  
R370 JSQ 1984  
R370/390/420 ->1989  
R310/330/340/365 1984->  
CBH/CLM280/340  
M140/160/200/230  
AE380/385TV/420TV/500/520  
MIDLINER GRANDE-BRETAGNE

"R" 1990->1992"  
C230/280/300/340TV/CCH300  
MAXTER 6X4 8X4  
CBH/CLM 320/385  
M/S 150/180/210/220/230TI/250  
"R" 1993->"  
G230/270 SP  
G220/270 BOM  
G200/210/230TI  
"G" MANAGER 4X2" & 6X2 & 6X4"  
G340TI 6X6 & 4X4  
G340TI TR 18T  
PREMIUM TR 4X2 =>1999

PREMIUM 6X2&6X2/4 =>1999  
MAXTER 4X2-4X4  
AE MAGNUM390/420TI/430/470/560  
PREMIUM PR 4X2 => 1999  
KERAX => 1999  
PG230/280  
MAGNUM E-TECH 400/440/480  
PREMIUM TR 4X2 2000 =>  
PREMIUM(FAB22E/H/J/Q/R)2000=>  
KERAX FAB 33A=>S 2000=>2002  
PREMIUM(FAB22EE/HA/HB/JJ/QQ/RR  
KERAX (FAB 33AA/././SS)  
KERAX (FAB33A/./R) 2003=>

**Sampa Nr.**  
**080.129**

**O.E.M. Nr.**  
**5005 010 008**



**Dimension**  
ø45xø48x53

**Description**  
Brake Camshaft Bushing

**Sampa Nr.**  
**080.548**

**O.E.M. Nr.**  
-



**Dimension**  
ø30

**Description**  
Rep. Kit for Brake Shoe

GRH235/HF26  
R310 4X2 ->8/84  
R360 4X2  
GBH/TBH280 1981->  
GBH260/280 6X6  
GLC/GLR190/230  
G260/290  
C260/290  
R360 6X4 -> 10/1983  
R310 6X4 JSQ 8/1984  
GLM/TLM280  
GLR230 4X4 SINPAR  
C210/CLR220  
G170

G210/230  
R370 JSQ 1984  
R370/390/420 ->1989  
R310/330/340/365 1984->  
CBH/CLM280/340  
G320  
M140/160/200/230  
AE380/385TV/420TV/500/520  
MIDLINER GRANDE-BRETAGNE  
"R" 1990->1992"  
C230/280/300/340TV/CCH300  
M/S 4X4 & INCENDIE  
ME/SE/CE/ 160/180/210  
MAXTER 6X4 8X4

CBH/CLM 320/385  
M/S 150/180/210/220/230TI/250  
"R"1993->"  
G230/270 SP  
G220/270 BOM  
G200/210/230TI  
"G" MANAGER 4X2"  
"G" MANAGER 6X2 & 6X4"  
G340TI 6X6  
G340TI 4X4  
G340TI TR 18T  
PREMIUM 6X2&6X2/4 =>1999  
MAXTER 4X2-4X4  
AE MAGNUM390/420TI/430/470/560

M210 4X4  
KERAX => 1999  
PG230/280 MAGNUM E-TECH  
400/440/480  
PREMIUM(FAB22E/H/J/Q/R)2000=>  
KERAX FAB 33A=>S 2000=>2002  
PREMIUM(FAB22EE/HA/HB/JJ/QQ/RR  
KERAX (FAB 33AA/././SS)  
KERAX (FAB33A/./R) 2003=>  
SISU  
KERAX 33G ARMEE BANGLADESH  
KERAX 33K ARMEE BANGLADESH

**Brake**



*Sampa Nr.*  
**080.126**  
*O.E.M. Nr.*  
**5010 067 400**

*Dimension*  
ø19.5xø30x104

*Description*  
Brake Shoe Pin



*Sampa Nr.*  
**111.005**  
*O.E.M. Nr.*  
**5010 260 575**

*Dimension*  
ø42xø62x25

*Description*  
Ball Bearing for Brake



*Sampa Nr.*  
**080.127**  
*O.E.M. Nr.*  
**5010 216 613**

*Dimension*  
ø30xø33x45

*Description*  
Brake Shoe Bushing

G170/210/230/260/290/320  
C260/290  
C210/CLR220  
R370/390/420 →1989  
R310/330/340/365 1984→  
CBH/CLM280/340  
M140/160/200/230  
AE380/385TI/420TI/500/520  
MIDLINER GRANDE-BRETAGNE  
"R" 1990→1992"  
C230/280/300/340TI/CCH300  
M/S 4X4 & INCENDIE  
ME/SE/CE/ 160/180/210  
MAXTER 6X4 8X4  
CBH/CLM 320/385  
M/S 150/180/210/220/230TI/250  
"R" 1993→"  
G230/270 SP  
G220/270 BOM  
G200/210/230TI  
"G" MANAGER 4X2"  
"G" MANAGER 6X2 & 6X4"  
G340TI 6X6  
G340TI 4X4  
G340TI TR 18T  
PREMIUM TR 4X2 ==>1999  
PREMIUM 6X2&6X2/4 ==>1999  
MAXTER 4X2-4X4  
AE MAGNUM390/420TI/430/470/560  
PREMIUM PR 4X2 ==> 1999  
M210 4X4  
KERAX ==> 1999  
PREMIUM 260 SP  
PG230/280  
MAGNUM E-TECH 400/440/480  
PREMIUM TR 4X2 2000 ==>  
PREMIUM(FAB22E/H/J/Q/R)2000==>  
PREMIUM PR 4X2 (FAB22A)2000==>  
KERAX FAB 33A==>S 2000==>2002  
PREMIUM TRACTEUR 4X2(FAB 22CC)  
PREMIUM(FAB22EE/HA/HB/JJ/QQ/RR  
PREMIUM PR 4X2 (FAB 22AA/AB)  
KERAX (FAB 33AA/././SS)  
KERAX (FAB33A/././R) 2003==>  
SISU  
PREMIUM 22C 071 ==> 1999  
KERAX 33G ARMEE BANGLADESH  
KERAX 33K ARMEE BANGLADESH



*Sampa Nr.*  
**080.547**  
*O.E.M. Nr.*  
-

*Dimension*  
ø30

*Description*  
Rep. Kit for Brake Shoe

AE380/385TI/420TI/500/520  
PREMIUM TR 4X2 ==>1999  
PREMIUM 6X2&6X2/4 ==>1999  
AE MAGNUM390/420TI/430/470/560  
PREMIUM PR 4X2 ==> 1999  
PREMIUM 260 SP  
MAGNUM E-TECH 400/440/480  
PREMIUM TR 4X2 2000 ==>  
PREMIUM(FAB22E/H/J/Q/R)2000==>  
PREMIUM PR 4X2 (FAB22A)2000==>  
PREMIUM TRACTEUR 4X2(FAB 22CC)  
PREMIUM(FAB22EE/HA/HB/JJ/QQ/RR  
PREMIUM PR 4X2 (FAB 22AA/AB)  
KERAX (FAB 33AA/././SS)  
PREMIUM 22C 071 ==> 1999



*Sampa Nr.*  
**075.012**  
*O.E.M. Nr.*  
**5000 816 347**

*Dimension*  
ø38xø60x55

*Description*  
Spherical Bearing

G260/290 "R" 1990→1992"  
R370/390/420 →1989 "R" 1993→"  
R310/330/340/365 1984→ "G" MANAGER 6X2 & 6X4"  
AE380/385TI/420TI/500/520 AE MAGNUM390/420TI/430/470/560

Sampa Nr.

**075.056**

O.E.M. Nr.

**5000 816 353 S**



*Dimension*  
ø31.7x73

*Description*

Brake Shoe Pin

G260/290  
R370/390/420 →1989  
R310/330/340/365 1984→  
AE380/385TI/420TI/500/520  
"R" 1990→1992"  
"R" 1993→"  
"G" MANAGER 6X2 & 6X4"  
AE MAGNUM390/420TI/430/470/560  
FREINS REMORQUE

Sampa Nr.

**075.011**

O.E.M. Nr.

**5000 816 349**



*Dimension*  
ø38.2xø42x44.8

*Description*

Brake Camshaft Bushing

G260/290  
R370/390/420 →1989  
R310/330/340/365 1984→  
AE380/385TI/420TI/500/520  
"R" 1990→1992"  
"R" 1993→"  
"G" MANAGER 6X2 & 6X4"  
AE MAGNUM390/420TI/430/470/560  
FREINS REMORQUE

Sampa Nr.

**075.535**

O.E.M. Nr.

**5000 816 353**



*Dimension*  
ø31.7x73

*Description*

Rep. Kit for Brake Shoe

G260/290  
R370/390/420 →1989  
R310/330/340/365 1984→  
AE380/385TI/420TI/500/520  
"R" 1990→1992"  
"R" 1993→"  
"G" MANAGER 6X2 & 6X4"  
AE MAGNUM390/420TI/430/470/560  
FREINS REMORQUE

Sampa Nr.

**080.562**

O.E.M. Nr.

-



*Dimension*  
ø31.7x73

*Description*

Rep. Kit for Brake Shoe

G260/290  
R370/390/420 →1989  
R310/330/340/365 1984→  
"R" 1990→1992"

Sampa Nr.

**075.045**

O.E.M. Nr.

**5000 816 356**



*Dimension*  
ø19xø31.7x55.5

*Description*

Cam Roller

G260/290  
R370/390/420 →1989  
R310/330/340/365 1984→  
AE380/385TI/420TI/500/520  
"R" 1990→1992"  
"R" 1993→"  
"G" MANAGER 6X2 & 6X4"  
AE MAGNUM390/420TI/430/470/560  
FREINS REMORQUE

Sampa Nr.

**080.549**

O.E.M. Nr.

**5000 816 356 S**



*Dimension*  
ø19xø31.7x55.5

*Description*

Rep. Kit for Brake Shoe

G260/290  
R370/390/420 →1989  
R310/330/340/365 1984→  
AE380/385TI/420TI/500/520  
"R" 1990→1992"  
"R" 1993→"  
"G" MANAGER 6X2 & 6X4"  
AE MAGNUM390/420TI/430/470/560  
FREINS REMORQUE

Brake



Sampa Nr.

**075.045**

O.E.M. Nr.

5000 816 356

Dimension

ø19xø31.7x55.5

Description

Cam Roller



Sampa Nr.

**075.039**

O.E.M. Nr.

5000 816 359

Dimension

ø25x227

Description

Brake Shoe Spring



Sampa Nr.

**080.130**

O.E.M. Nr.

5000 816 358

Dimension

ø12x64

Description

Brake Shoe Spring Pin

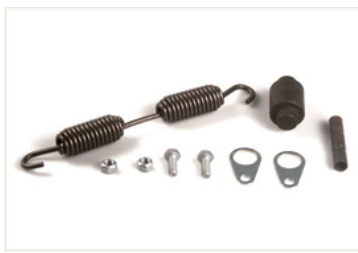

Sampa Nr.

**080.550**

O.E.M. Nr.

-

Dimension

ø19xø31.7x55.5

Description

Rep. Kit for Brake Shoe

G260/290  
R370/390/420 →1989  
R310/330/340/365 1984→  
G320

AE380/385TI/420TI/500/520  
"R" 1990→1992"  
"R" 1993→"  
"G" MANAGER 6X2 & 6X4"

AE MAGNUM390/420TI/430/470/560  
FREINS REMORQUE

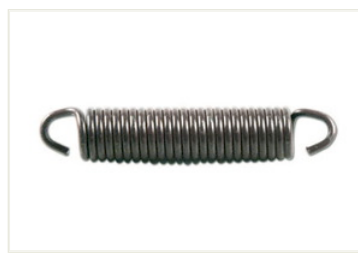

Sampa Nr.

**080.099**

O.E.M. Nr.

0023 532 373

Dimension

ø32x167

Description

Brake Shoe Spring



Sampa Nr.

**080.144**

O.E.M. Nr.

0000 174 268

Dimension

ø32x200

Description

Return Spring

TR/GR305  
TR/GR350  
GB131/HR15  
GB/TB191/231  
GC191/231  
GR191/231  
GRH235/HF26  
GR/TR280  
GRH/TRH305  
GRH/TRH350  
TF231D  
GF151D  
R310 4X2 →8/84  
R360 4X2  
GBH/TBH280 1981→  
PJK/PJN/PJP  
PGC191/231  
GBH260/280 6X6  
GBH260/280 6X4 →1980

GLC/GLR190/230  
JE13/15  
G260/290  
C260/290  
R360 6X4 → 10/1983  
R310 6X4 JSQ 8/1984  
S170 (FAB=SH)  
GLM/TLM280  
GLR230 4X4 SINPAR  
C210/CLR220  
G170  
G210/230  
R370 JSQ 1984  
CBH/CLM280/340  
M/S 4X4 & INCENDIE  
ME/SE/CE/ 160/180/210  
G230/270 SP  
STANDARD FREINAGE

GRH235/HF26  
GR/TR280  
GRH/TRH305  
GRH/TRH350  
R310 4X2 →8/84  
R360 4X2  
GBH/TBH280 1981→  
GBH260/280 6X6  
GBH260/280 6X4 →1980  
GLC/GLR190/230  
G260/290  
C260/290  
R360 6X4 → 10/1983  
R310 6X4 JSQ 8/1984  
GLM/TLM280  
GLR230 4X4 SINPAR  
C210/CLR220  
G170  
G210/230  
R370 JSQ 1984  
R370/390/420 →1989

R310/330/340/365 1984→  
CBH/CLM280/340  
G320  
AE380/385TI/420TI/500/520  
"R" 1990→1992"  
C230/280/300/340TI/CCH300  
CBH/CLM 320/385  
"R" 1993→"  
G230/270 SP  
G220/270 BOM  
G200/210/230TI  
"G" MANAGER 4X2"  
"G" MANAGER 6X2 & 6X4"  
G340TI 4X4  
G340TI TR 18T  
PREMIUM 6X2&6X2/4 →1999  
AE MAGNUM390/420TI/430/470/560  
MAGNUM E-TECH 400/440/480  
PREMIUM(FAB22E/H/J/Q/R)2000→  
PREMIUM(FAB22EE/HA/HB/JJ/QQ/RR  
STANDARD FREINAGE

Sampa Nr.

**080.050**

O.E.M. Nr.

5010 098 945

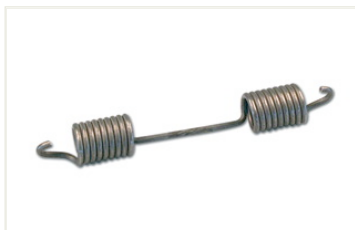

Dimension

ø35x240

Description

Brake Shoe Spring

Sampa Nr.

**080.103**

O.E.M. Nr.

5010 098 946



Dimension

ø15x76

Description

Brake Shoe Spring Pin

AE380/385TI/420TI/500/520  
 PREMIUM TR 4X2 ==>1999  
 PREMIUM 6X2&6X2/4 ==>1999  
 AE MAGNUM390/420TI/430/470/560  
 PREMIUM PR 4X2 ==> 1999  
 PREMIUM 260 SP  
 MAGNUM E-TECH 400/440/480  
 PREMIUM TR 4X2 2000 ==>  
 PREMIUM(FAB22E/H/J/Q/R)2000==>  
 PREMIUM PR 4X2 (FAB22A)2000==>  
 KERAX FAB 33A==>S 2000==>2002  
 PREMIUM TRACTEUR 4X2(FAB 22CC)  
 PREMIUM(FAB22EE/HA/HB/JJ/QQ/RR  
 PREMIUM PR 4X2 (FAB 22AA/AB)  
 KERAX (FAB 33AA/././SS)  
 KERAX (FAB33A/././R) 2003==>  
 PREMIUM 22C 071 ==> 1999  
 PUNCHER  
 STANDARD FREINAGE

Sampa Nr.

**080.565**

O.E.M. Nr.

-



Dimension

ø25

Description

Rep. Kit for Brake Shoe

AE380/385TI/420TI/500/520	PREMIUM TR 4X2 2000 ==>
PREMIUM TR 4X2 ==>1999	PREMIUM(FAB22E/H/J/Q/R)2000==>
PREMIUM 6X2&6X2/4 ==>1999	KERAX FAB 33A==>S 2000==>2002
AE MAGNUM390/420TI/430/470/560	PREMIUM(FAB22EE/HA/HB/JJ/QQ/RR
PREMIUM PR 4X2 ==> 1999	KERAX (FAB 33AA/././SS)
MAGNUM E-TECH 400/440/480	KERAX (FAB33A/././R) 2003==>

Sampa Nr.

**080.101**

O.E.M. Nr.

5000 716 656



Dimension

ø25xø50x24.5

Description

Brake Shoe Roller

Sampa Nr.

**080.104**

O.E.M. Nr.

5000 716 600



Dimension





ø25x63

Description

Brake Shoe Pin

G260/290	KERAX ==> 1999
C260/290	PREMIUM 260 SP
C210/CLR220	PG230/280
G170	MAGNUM E-TECH 400/440/480
G210/230	PREMIUM TR 4X2 2000 ==>
F370/390/420 -->1989	PREMIUM(FAB22E/H/J/Q/R)2000==>
F310/330/340/365 1984-->	PREMIUM PR 4X2 (FAB22A)2000==>
CBH/CLM280/340	KERAX FAB 33A==>S 2000==>2002
G320	PREMIUM TRACTEUR 4X2(FAB 22CC)
M140/160/200/230	PREMIUM(FAB22EE/HA/HB/JJ/QQ/RR
AE380/385TI/420TI/500/520	PREMIUM PR 4X2 (FAB 22AA/AB)
MIDLINER GRANDE-BRETAGNE	KERAX (FAB 33AA/././SS)
"R" 1990-->1992"	KERAX (FAB33A/././R) 2003==>
C230/280/300/340TI/CCH300	SISU
M/S 4X4 & INCENDIE	PREMIUM 22C 071 ==> 1999
ME/SE/CE/ 160/180/210	KERAX 33G ARMEE BANGLADESH
MAXTER 6X4 8X4	KERAX 33K ARMEE BANGLADESH
CBH/CLM 320/385	PUNCHER
M/S 150/180/210/220/230TI/250	
"R" 1993-->"	
G230/270 SP	
G220/270 BOM	
G200/210/230TI	
"G" MANAGER 4X2"	
"G" MANAGER 6X2 & 6X4"	
G340TI 6X6	
G340TI 4X4	
G340TI TR 18T	
PREMIUM TR 4X2 ==>1999	
PREMIUM 6X2&6X2/4 ==>1999	
MAXTER 4X2-4X4	
AE MAGNUM390/420TI/430/470/560	
PREMIUM PR 4X2 ==> 1999	
M210 4X4	

## Brake

	<p><i>Sampa Nr.</i></p> <p><b>080.051</b></p> <p><i>O.E.M. Nr.</i></p> <p>5010 097 089</p>		<p><i>Sampa Nr.</i></p> <p><b>080.052</b></p> <p><i>O.E.M. Nr.</i></p> <p>5010 097 340</p>
<p><i>Dimension</i></p> <p>ø30x233</p>		<p><i>Dimension</i></p> <p>ø38x145</p>	
<p><i>Description</i></p> <p>Brake Shoe Spring</p>			
	<p><i>Sampa Nr.</i></p> <p><b>080.101</b></p> <p><i>O.E.M. Nr.</i></p> <p>5000 716 656</p>		<p><i>Sampa Nr.</i></p> <p><b>080.104</b></p> <p><i>O.E.M. Nr.</i></p> <p>5000 716 600</p>
<p><i>Dimension</i></p> <p>ø25xø50x24.5</p>		<p><i>Dimension</i></p> <p>ø25x63</p>	
<p><i>Description</i></p> <p>Brake Shoe Roller</p>			
	<p><i>Sampa Nr.</i></p> <p><b>080.135</b></p> <p><i>O.E.M. Nr.</i></p> <p>5010 097 262</p>		<p><i>Sampa Nr.</i></p> <p><b>080.564</b></p> <p><i>O.E.M. Nr.</i></p> <p>-</p>
<p><i>Dimension</i></p> <p>ø12x96</p>		<p><i>Dimension</i></p> <p>ø25</p>	
<p><i>Description</i></p> <p>Brake Shoe Spring Pin</p>			
<p>G260/290 C260/290 C210/CLR220 G170 G210/230 R370/390/420 —&gt;1989 R310/330/340/365 1984—&gt; CBH/CLM280/340 G320 M140/160/200/230 AE380/385TI/420TI/500/520 MIDLINER GRANDE-BRETAGNE "R" 1990—&gt;1992" C230/280/300/340TI/CCH300 M/S 4X4 &amp; INCENDIE ME/SE/CE/ 160/180/210 MAXTER 6X4 8X4</p>	<p>CBH/CLM 320/385 M/S 150/180/210/220/230TI/250 "R" 1993—&gt;" G230/270 SP G220/270 BOM G200/210/230TI "G" MANAGER 4X2" "G" MANAGER 6X2 &amp; 6X4" G340TI 6X6 G340TI 4X4 G340TI TR 18T PREMIUM TR 4X2 ==&gt;1999 PREMIUM 6X2&amp;6X2/4 ==&gt;1999 MAXTER 4X2-4X4 AE MAGNUM390/420TI/430/470/560 PREMIUM PR 4X2 ==&gt; 1999 M210 4X4</p>	<p>KERAX ==&gt; 1999 PREMIUM 260 SP PG230/280 MAGNUM E-TECH 400/440/480 PREMIUM TR 4X2 2000 ==&gt; PREMIUM(FAB22E/H/J/Q/R)2000==&gt; PREMIUM PR 4X2 (FAB22A)2000==&gt; KERAX FAB 33A==&gt;S 2000==&gt;2002 PREMIUM TRACTEUR 4X2(FAB 22CC) PREMIUM(FAB22EE/HA/HB/JJ/QQ/RR) PREMIUM PR 4X2 (FAB 22AA/AB) KERAX (FAB 33AA/././SS) KERAX (FAB33A/././R) 2003==&gt; SISU PREMIUM 22C 071 ==&gt; 1999 KERAX 33G ARMEE BANGLADESH KERAX 33K ARMEE BANGLADESH</p>	

Sampa Nr.

**080.102**

O.E.M. Nr.

**0000 189 976**



Dimension

ø25xø60x20

Description

Brake Shoe Roller

TR/GR305	R360 4X2	GLM/TLM280
TR/GR350	GBH/TBH280 1981→	GLR230 4X4 SINPAR
GR191/231	GBH260/280 6X6	C210/CLF220
GRH235/HF26	GBH260/280 6X4 →1980	G170
GR/TR280	GLC/GLR190/230	G210/230
GRH/TRH305	G260/290	R370 JSQ 1984
GRH/TRH350	C260/290	CBH/CLM280/340
TF231D	R360 6X4 → 10/1983	G230/270 SP
R310 4X2 →8/84	R310 6X4 JSQ 8/1984	

Sampa Nr.

**080.107**

O.E.M. Nr.

**0000 192 399**



Dimension

ø25x75

Description

Brake Shoe Pin

TR/GR305	R360 4X2	GLM/TLM280
TR/GR350	GBH/TBH280 1981→	GLR230 4X4 SINPAR
GR191/231	GBH260/280 6X6	C210/CLF220
GRH235/HF26	GBH260/280 6X4 →1980	G170
GR/TR280	GLC/GLR190/230	G210/230
GRH/TRH305	G260/290	R370 JSQ 1984
GRH/TRH350	C260/290	CBH/CLM280/340
TF231D	R360 6X4 → 10/1983	G230/270 SP
R310 4X2 →8/84	R310 6X4 JSQ 8/1984	

Sampa Nr.

**080.137**

O.E.M. Nr.

**5000 786 674**



Dimension

ø30xø33x20

Description

Brake Shoe Bushing

TR/GR305	GBH/TBH280 1981→	C210/CLF220
TR/GR350	GBH260/280 6X6	G170
GR191/231	GBH260/280 6X4 →1980	G210/230
GRH235/HF26	GLC/GLR190/230	R370 JSQ 1984
GR/TR280	G260/290	R370/390/420 →1989
GRH/TRH305	C260/290	R310/330/340/365 1984→
GRH/TRH350	R360 6X4 → 10/1983	CBH/CLM280/340
TF231D	R310 6X4 JSQ 8/1984	G230/270 SP
R310 4X2 →8/84	GLM/TLM280	
R360 4X2	GLR230 4X4 SINPAR	

Sampa Nr.

**080.106**

O.E.M. Nr.

**5000 737 307**



Dimension

ø30x93

Description

Brake Shoe Pin

TR/GR305	GBH/TBH280 1981→	C210/CLF220
TR/GR350	GBH260/280 6X6	G170
GR191/231	GBH260/280 6X4 →1980	G210/230
GRH235/HF26	GLC/GLR190/230	R370 JSQ 1984
GR/TR280	G260/290	R370/390/420 →1989
GRH/TRH305	C260/290	R310/330/340/365 1984→
GRH/TRH350	R360 6X4 → 10/1983	CBH/CLM280/340
TF231D	R310 6X4 JSQ 8/1984	G230/270 SP
R310 4X2 →8/84	GLM/TLM280	
R360 4X2	GLR230 4X4 SINPAR	

Sampa Nr.

**080.136**

O.E.M. Nr.

**5005 016 005**



Dimension

ø38x156

Description

Brake Shoe Spring

TR/GR305	R360 4X2	GLM/TLM280
TR/GR350	GBH/TBH280 1981→	GLR230 4X4 SINPAR
GR191/231	GBH260/280 6X6	C210/CLF220
GRH235/HF26	GBH260/280 6X4 →1980	G170
GR/TR280	GLC/GLR190/230	G210/230
GRH/TRH305	G260/290	R370 JSQ 1984
GRH/TRH350	C260/290	CBH/CLM280/340
TF231D	R360 6X4 → 10/1983	G230/270 SP
R310 4X2 →8/84	R310 6X4 JSQ 8/1984	

Sampa Nr.

**080.567**

O.E.M. Nr.

-



Dimension

Description

Rep. Kit for Brake Shoe

TR/GR305	R360 4X2	GLM/TLM280
TR/GR350	GBH/TBH280 1981→	GLR230 4X4 SINPAR
GR191/231	GBH260/280 6X6	C210/CLF220
GRH235/HF26	GBH260/280 6X4 →1980	G170
GR/TR280	GLC/GLR190/230	G210/230
GRH/TRH305	G260/290	R370 JSQ 1984
GRH/TRH350	C260/290	CBH/CLM280/340
TF231D	R360 6X4 → 10/1983	G230/270 SP
R310 4X2 →8/84	R310 6X4 JSQ 8/1984	

**Brake**



**Sampa Nr.**  
**080.052**  
**O.E.M. Nr.**  
**5010 097 340**

**Dimension**  
ø38x145

**Description**  
Brake Shoe Spring



**Sampa Nr.**  
**080.101**  
**O.E.M. Nr.**  
**5000 716 656**

**Dimension**  
ø25xø50x24.5

**Description**  
Brake Shoe Roller



**Sampa Nr.**  
**080.104**  
**O.E.M. Nr.**  
**5000 716 600**

**Dimension**  
ø25x63

**Description**  
Brake Shoe Pin



**Sampa Nr.**  
**080.105**  
**O.E.M. Nr.**  
**5000 737 308**

**Dimension**  
ø30x110.5

**Description**  
Brake Shoe Pin

G260/290 C260/290 C210/CLR220 G170 G210/230 R370/390/420 →1989 R310/330/340/365 1984→ CBH/CLM280/340 G320 M140/160/200/230 AE380/385TI/420TI/500/520 MIDLINER GRANDE-BRETAGNE "R" 1990→1992" C230/280/300/340TI/CCH300 M/S 4X4 & INCENDIE ME/SE/CE/ 160/180/210 MAXTER 6X4 8X4 CBH/CLM 320/385 M/S 150/180/210/220/230TI/250 "R" 1993→" G230/270 SP G220/270 BOM G200/210/230TI "G" MANAGER 4X2" "G" MANAGER 6X2 & 6X4" G340TI 6X6	G340TI 4X4 G340TI TR 18T PREMIUM TR 4X2 ⇒1999 PREMIUM 6X2&6X2/4 ⇒1999 MAXTER 4X2-4X4 AE MAGNUM390/420TI/430/470/560 PREMIUM PR 4X2 ⇒ 1999 M210 4X4 KERAX ⇒ 1999 PREMIUM 260 SP PG230/280 MAGNUM E-TECH 400/440/480 PREMIUM TR 4X2 2000 ⇒ PREMIUM(FAB22E/H/J/Q/R)2000⇒ PREMIUM PR 4X2 (FAB22A)2000⇒ KERAX FAB 33A⇒S 2000⇒2002 PREMIUM TRACTEUR 4X2(FAB 22CC) PREMIUM(FAB22EE/HA/HB/JJ/QQ/RR PREMIUM PR 4X2 (FAB 22AA/AB) KERAX (FAB 33AA/././SS) KERAX (FAB33A/./R) 2003⇒ SISU PREMIUM 22C 071 ⇒ 1999 KERAX 33G ARMEE BANGLADESH KERAX 33K ARMEE BANGLADESH STANDARD FREINAGE
---	---

G260/290  
C260/290  
C210/CLR220  
G170  
G210/230  
R370/390/420 →1989  
R310/330/340/365 1984→  
G230/270 SP



**Sampa Nr.**  
**080.572**  
**O.E.M. Nr.**  
-

**Dimension**

**Description**  
Rep. Kit for Brake Shoe

G260/290 C260/290 C210/CLR220 G170	G210/230 R370/390/420 →1989 R310/330/340/365 1984→ G230/270 SP
---	---



**Sampa Nr.**  
**080.137**  
**O.E.M. Nr.**  
**5000 786 674**

**Dimension**  
ø30xø33x20

**Description**  
Brake Shoe Bushing

TR/GR305 TR/GR350 GR191/231 GRH235/HF26 GR/TR280 GRH/TRH305 GRH/TRH350 TF231D R310 4X2 ->8/84 R360 4X2 GBH/TBH280 1981→ GBH260/280 6X6 GBH260/280 6X4 →1980 GLC/GLR190/230	G260/290 C260/290 R360 6X4 → 10/1983 R310 6X4 JSQ 8/1984 GLM/TLM280 GLR230 4X4 SINPAR C210/CLR220 G170 G210/230 R370 JSQ 1984 R370/390/420 →1989 R310/330/340/365 1984→ CBH/CLM280/340 G230/270 SP
---	---

**Sampa Nr.**  
**080.229**

**O.E.M. Nr.**  
**0000 241 884**

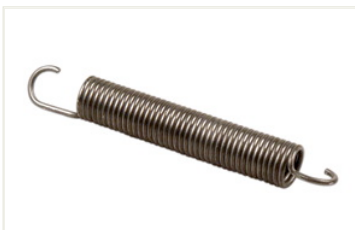

**Dimension**  
ø24x172

**Description**  
Return Spring

GLM/TLM280 C210/CLR220 CBH/CLM 320/385  
GLR230 4X4 SINPAR R370 JSQ 1984 TR/GR350

**Sampa Nr.**  
**080.078**

**O.E.M. Nr.**  
**5000 737 271**



**Dimension**  
ø245x478x38

**Description**  
Dust Cover

G210/230/260/290/320 C260/290 C210/CLR220 R370/390/420 →1989 R310/330/340/365 1984→ CBH/CLM280/340 "R" 1990→>1992" C230/280/300/340TI/CCH300 CBH/CLM 320/385 "R" 1993→>" "G" MANAGER 6X2 & 6X4"

**Sampa Nr.**  
**080.080**

**O.E.M. Nr.**  
**5000 716 313**



**Dimension**  
ø245xø466x41

**Description**  
Dust Cover

TR/GR305/350 GR191/231/TF280 GRH235/HF26 GRH/TRH305/350 TF231D R310 4X2 →8/84 R360 4X2 GBH/TBH280 1981→ GBH260/280/6X6 GBH260/280/6X4 →1980 GLC/GLR190/230 G170/210/230/260/290/320 C260/290/210/CLR220 R360 6X4 → 10/1983 R310 6X4 JSQ 8/1984 GLM/TLM280 GLR230 4X4 SINPAR R370 JSQ 1984 R370/390/420 →1989 R310/330/340/365 1984→ CBH/CLM280/340 M140/160/200/230 AE380/385TI/420TI/500/520 MIDLINER GRANDE-BRETAGNE "R" 1990→>1992" C230/280/300/340TI/CCH300 MAXTER 6X4 8X4 CBH/CLM 320/385 M/S 150/180/210/220/230TI/250 "R" 1993→>" G230/270 SP/220/270 BCM/200/210/230TI "G" MANAGER 4X2" & 6X2 & 6X4" G340TI 6X6 4X4 G340TI TR 18T PREMIUM 6X2&6X2/4 →1999 MAXTER 4X2-4X4 AE MAGNUM390/420TI/430/470/560 KERAX → 1999 PG230/280 MAGNUM E-TECH 400/440/480 PREMIUM/FAB22E/H/J/Q/R/2000→> KERAX FAB 33A→>S 2000→>2002 PREMIUM/FAB22EE/H/HB/J/Q/R/R KERAX (FAB 33AA//./SS) KERAX (FAB33A//./R) 2000→> SISU

**Sampa Nr.**  
**080.231**

**O.E.M. Nr.**  
**0000 492 878**



**Dimension**  
ø23x208

**Description**  
Return Spring

GRH235/HF26 GRH/TRH305 GRH/TRH350 GBH/TBH280 1981→ GBH260/280 6X4->1980 G260/290 C260/290 R360 6X4->10/1983 R310 6X4 JSQ 8/1984 R370 JSQ 1984 R370/390/420->1989 R310/330/340/365 1984→> CBH/CLM280/340 AE380/385TI/420TI/500/520 R 1990→>1992 C230/280/300/340TI/CCH300 MAXTER 6X4 8X4 CBH/CLM 320/385 R 1993→> G MANAGER 6X2 & 6X4 G340TI 6X6 AE MAGNUM390/420TI/430/470/560 KERAX→>1999 KERAX FAB 33A→>S 2000→>2002 KERAX (FAB 33AA//./SS)

**Sampa Nr.**  
**080.079**

**O.E.M. Nr.**  
**5000 716 310**



**Dimension**  
ø245xø466x41

**Description**  
Dust Cover

G170/210/230/260/290 C260/290 R370/390/420 →1989 R310/330/340/365 1984→> M140/160/200/230 MIDLINER GRANDE-BRETAGNE M/S 4X4 & INCENDIE ME/SE/CE/ 160/180/210 M/S 150/180/210/220/230TI/250 G230/270 SP M210 4X4

**Sampa Nr.**  
**080.081**

**O.E.M. Nr.**  
**5010 260 114**



**Dimension**  
ø250xø466x63

**Description**  
Dust Cover

MAXTER 6X4 8X4 "R" 1993→>" PREMIUM 6X2&6X2/4 →1999 MAXTER 4X2-4X4 KERAX → 1999 PREMIUM TR 4X2 2000 →> PREMIUM(FAB22E/H/J/Q/R)2000→> KERAX FAB 33A→>S 2000→>2002 PREMIUM(FAB22EE/H/HB/J/Q/R/R KERAX (FAB 33AA//./SS) KERAX (FAB33A//./R) 2003→> KERAX 33G ARMEE BANGLADESH KERAX 33K ARMEE BANGLADESH

## Brake



Sampa Nr.

**080.082**

O.E.M. Nr.

**5010 260 113**

Dimension

ø250xø466x63

Description

Dust Cover

MAXTER 6X4 8X4 "R" 1993—>	KERAX FAB 33A—>S 2000—>2002 PREMIUM(FAB22EE/HA/HB/JJ/QQ/RR)
PREMIUM 6X2&6X2/4 =>1999	KERAX (FAB 33AA././SS)
MAXTER 4X2-4X4	KERAX (FAB33A././R) 2003=>
KERAX => 1999	KERAX 33G ARMEE BANGLADESH
PREMIUM TR 4X2 2000 =>	KERAX 33K ARMEE BANGLADESH
PREMIUM(FAB22E/H/J/Q/R)2000=>	



Sampa Nr.

**080.085**

O.E.M. Nr.

**5000 737 306**

Dimension

ø245xø478x36

Description

Dust Cover

G170/260/290/320 G210/230 R370/390/420 —>1989 R310/330/340/365 1984—> "R" 1990—>1992"	C230/280/300/340TI/CCH300 "R" 1993—> G230/270 SP "G" MANAGER 4X2"
---	--



Sampa Nr.

**080.083**

O.E.M. Nr.

**5010 136 144**

Dimension

ø250xø466x63

Description

Dust Cover

AE380/385TI/420TI/500/520 "R" 1990—>1992"	PREMIUM TR 4X2 =>1999
CBH/CLM 320/385 "R" 1993—>	PREMIUM 6X2&6X2/4 =>1999
G220/270 BOM	AE MAGNUM390/420TI/430/470/560
G200/210/230TI	PREMIUM PR 4X2 => 1999
"G" MANAGER 4X2"	PG230/280
"G" MANAGER 6X2 & 6X4"	MAGNUM E-TECH 400/440/480
G340TI TR 18T	PREMIUM(FAB22E/H/J/Q/R)2000=>
	PREMIUM(FAB22EE/HA/HB/JJ/QQ/RR)



Sampa Nr.

**080.086**

O.E.M. Nr.

**5000 737 576**

Dimension

ø232x478x43

Description

Dust Cover

G260/290 G210/230 M140/160/200/230	MIDLINER GRANDE-BRETAGNE M/S 150/180/210/220/230TI/250 G220/270 BOM
--	---



Sampa Nr.

**080.084**

O.E.M. Nr.

**0003 337 605**

Dimension

ø240xø480x31

Description

Dust Cover

TR/GR305	TF231D	C260/290
TR/GR350	GF151D	R360 6X4 —> 10/1983
GB131/HR15	R310 4X2 ->8/84	R310 6X4 JSQ 8/1984
GB/TB191/231	R360 4X2	GLR230 4X4 SINPAR
GC191/231	GBH/TBH280 1981—>	C210/CLF220
GR191/231	PGC191/231	G170
GRH235/HF26	GBH260/280 6X6	G210/230
GR/TF280	GBH260/280 6X4 —>1980	R370 JSQ 1984
GRH/TRH305	GLC/GLR190/230	CBH/CLM280/340
GRH/TRH350	G260/290	



Sampa Nr.

**080.087**

O.E.M. Nr.

**5000 296 427**

Dimension

ø110xø338x34/70

Description

Dust Cover

B90  
B80/110/120



Sampa Nr.

**080.088**

O.E.M. Nr.

**5000 296 428**

Dimension

ø110xø338x34/70

Description

Dust Cover

B90  
B80/110/120

Sampa Nr.

**080.089**

O.E.M. Nr.

**5010 098 794  
(5010 098 795)**



Dimension

ø245xø466x46

Description

Dust Cover

AE380/385TI/420TI/500/520  
PREMIUM TR 4X2 =>1999  
PREMIUM 6X2&6X2/4 =>1999  
AE MAGNUM390/420TI/430/470/560  
PREMIUM PR 4X2 => 1999  
PREMIUM 260 SP  
MAGNUM E-TECH 400/440/480  
PREMIUM TR 4X2 2000 =>  
PREMIUM(FAB22E/H/J/Q/R)2000=>  
PREMIUM PR 4X2 (FAB22A)2000=>  
KERAX FAB 33A=>S 2000=>2002  
PREMIUM TRACTEUR 4X2(FAB 22CC)  
PREMIUM(FAB22EE/H/HB/JJ/QQ/RR)  
PREMIUM PR 4X2 (FAB 22AA/AB)  
KERAX (FAB 33AA/././SS)  
KERAX (FAB33A/./R) 2003=>  
PREMIUM 22C 071 => 1999  
PUNCHER

Sampa Nr.

**080.160**

O.E.M. Nr.

**5010 525 628**



Dimension

ø218xø435x64

Description

Dust Cover

KERAX (FAB 33AA/././SS)  
KERAX (FAB 33A/./R) 2003=>

Sampa Nr.

**030.216**

O.E.M. Nr.

**7420 367 343**



Dimension

234x446x54

Description

Dust Cover

KERAX DXI

Sampa Nr.

**080.090**

O.E.M. Nr.

**5000 792 560  
(5000 792 558)**



Dimension

ø225xø470x33

Description

Dust Cover

CBH/CLM280/340 "G" MANAGER 4X2"  
C230/280/300/340TI/CCH300 G340TI 4X4  
CBH/CLM 320/385

Sampa Nr.

**075.532**

O.E.M. Nr.

**5000 816 369**



Dimension

ø230xø467x65

Description

Dust Cover Set

G260/290 "R" 1990->1992"  
R370/390/420 ->1989 "R" 1993->"  
R310/330/340/365 1984-> "G" MANAGER 6X2 & 6X4"  
AE380/385TI/420TI/500/520 AE MAGNUM390/420TI/430/470/560

Sampa Nr.

**080.091**

O.E.M. Nr.

**5000 792 559  
(5000 792 561)**



Dimension

ø225xø470x33

Description

Dust Cover

CBH/CLM280/340 "G" MANAGER 4X2"  
C230/280/300/340TI/CCH300 G340TI 4X4  
CBH/CLM 320/385

Sampa Nr.

**075.544**

O.E.M. Nr.

**5000 816 935**



Dimension

ø230xø465x54

Description

Dust Cover Set

G260/290 R310/330/340/365 1984->  
R370/390/420 ->1989 "R" 1990->1992"

Brake



Sampa Nr.  
**095.509**  
O.E.M. Nr.  
**MCK-1171/N**

Dimension

Description  
Rep. Kit for Brake Caliper



Sampa Nr.  
**095.510**  
O.E.M. Nr.  
**MCK-1102/N**

Dimension

Description  
Rep. Kit for Brake Caliper

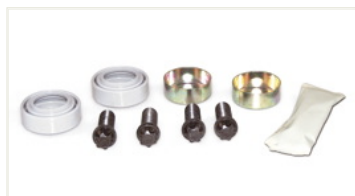

Sampa Nr.  
**095.511**  
O.E.M. Nr.  
**MCK 1253**

Dimension

Description  
Rep. Kit for Brake Caliper



Sampa Nr.  
**095.512**  
O.E.M. Nr.  
**MCK 1254**

Dimension

Description  
Rep. Kit for Brake Caliper



Sampa Nr.  
**095.574**  
O.E.M. Nr.  
**5001 866 989**

Dimension

Description  
Rep. Kit for Brake Caliper  
  
MAGNUM DXI 12-VAR-120AV  
PREMIUM DXI 11-FAB-27JC/TC  
PREMIUM DXI 11-FAB-27RC/SC



Sampa Nr.  
**095.575**  
O.E.M. Nr.  
**5001 858 717**

Dimension

Description  
Rep. Kit for Brake Caliper  
  
MAGNUM E-TECH 400/440/480  
PREMIUM(FAB22E/H/J/Q/R)2000==>  
PREMIUM PR 4X2 (FAB22A)2000==>  
PREMIUM TRACTEUR 4X2(FAB 22CC)  
PREMIUM(FAB22EE/HA/HB/JJ/QQ/RR)  
PREMIUM PR 4X2 (FAB 22AA/AB)



Sampa Nr.  
**095.576**  
O.E.M. Nr.  
**5001 860 791**

Dimension

Description  
Rep. Kit for Brake Caliper  
  
MAGNUM E-TECH 400/440/480  
MIDLUM 42B3/4-44TMC.-45D./E.  
PREMIUM TRACTEUR 4X2(FAB 22CC)  
PREMIUM(FAB22EE/HA/HB/JJ/QQ/RR)  
PREMIUM PR 4X2 (FAB 22AA/AB)  
SISU



Sampa Nr.  
**095.577**  
O.E.M. Nr.  
**5001 866 400**

Dimension

Description  
Rep. Kit for Brake Caliper  
  
MAGNUM DXI 12-VAR-120AV  
PREMIUM DXI 11-FAB-27JC/TC  
PREMIUM DXI 11-FAB-27RC/SC

Sampa Nr.

**095.578**

O.E.M. Nr.

**5001 858 718  
(5001 860 792)**



Dimension

Description

Rep. Kit for Brake Caliper

MAGNUM E-TECH 400/440/480	PREMIUM PR 4X2 (FAB 22AA/AB)
PREMIUM(FAB22E/H/J/Q/R)2000=>	MIDLUM 42B3/4-44TMC.-45D/E
PREMIUM PR 4X2 (FAB22A)2000=>	SISU
PREMIUM TRACTEUR 4X2(FAB 22CC)	
PREMIUM(FAB22EE/HA/HB/JJ/QQ/RR)	

Sampa Nr.

**095.579**

O.E.M. Nr.

**5001 866 398**



Dimension

Description

Rep. Kit for Brake Caliper

MAGNUM DXI 12-VAR-120AV  
PREMIUM DXI 11-FAB-27JC/TC  
PREMIUM DXI 11-FAB-27RC/SC

Sampa Nr.

**095.513**

O.E.M. Nr.

**MCK 1139**



Dimension

Description

Rep. Kit for Brake Caliper

Sampa Nr.

**095.514**

O.E.M. Nr.

**MCK 1238**



Dimension

Description

Rep. Kit for Brake Caliper

Sampa Nr.

**095.515**

O.E.M. Nr.

**MCK 1171**



Dimension

Description

Rep. Kit for Brake Caliper

Sampa Nr.

**095.516**

O.E.M. Nr.

**MCK 1192**



Dimension

Description

Rep. Kit for Brake Caliper

Sampa Nr.

**095.517**

O.E.M. Nr.

**5001 837 006**



Dimension

Description

Rep. Kit for Brake Caliper

AE380/385TI/420TI/500/520	MAGNUM E-TECH 400/440/480
PREMIUM TR 4X2 ==>1999	PREMIUM TR 4X2 2000 ==>
PREMIUM 6X2&6X2/4 ==>1999	PREMIUM(FAB22E/H/J/Q/R)2000==>
AE MAGNUM390/420TI/430/470/560	PREMIUM PR 4X2 (FAB22A)2000==>
PREMIUM PR 4X2 ==> 1999	PREMIUM PR 4X2 (FAB 22AA/AB)
PREMIUM 260 SP	PREMIUM 22C 071 ==> 1999

Sampa Nr.

**095.580**

O.E.M. Nr.

**5001 822 994**











Dimension

Description

Rep. Kit for Brake Caliper

AE380/385TI/420TI/500/520  
PREMIUM TR 4X2 ==>1999  
PREMIUM 6X2&6X2/4 ==>1999  
AE MAGNUM390/420TI/430/470/560  
PREMIUM PR 4X2 ==> 1999

## Brake

	<p><i>Sampa Nr.</i> <b>095.524</b></p> <p><i>O.E.M. Nr.</i> <b>K 001300</b></p>		<p><i>Sampa Nr.</i> <b>095.572</b></p> <p><i>O.E.M. Nr.</i> <b>K 010603</b></p>
<p><i>Dimension</i></p>		<p><i>Dimension</i></p>	
<p><i>Description</i></p> <p>Rep. Kit for Brake Caliper</p>		<p><i>Description</i></p> <p>Rep. Kit for Brake Caliper</p>	
	<p><i>Sampa Nr.</i> <b>095.573</b></p> <p><i>O.E.M. Nr.</i> <b>K 010604</b></p>		<p><i>Sampa Nr.</i> <b>095.581</b></p> <p><i>O.E.M. Nr.</i> <b>K 000944</b></p>
<p><i>Dimension</i></p>		<p><i>Dimension</i></p>	
<p><i>Description</i></p> <p>Rep. Kit for Brake Caliper</p>		<p><i>Description</i></p> <p>Rep. Kit for Brake Caliper</p>	
	<p><i>Sampa Nr.</i> <b>095.521</b></p> <p><i>O.E.M. Nr.</i> <b>II 304130065</b></p>		<p><i>Sampa Nr.</i> <b>095.519</b></p> <p><i>O.E.M. Nr.</i> <b>K 000696</b></p>
<p><i>Dimension</i></p>		<p><i>Dimension</i></p>	
<p><i>Description</i></p> <p>Rep. Kit for Brake Caliper</p>		<p><i>Description</i></p> <p>Rep. Kit for Brake Caliper</p>	
	<p><i>Sampa Nr.</i> <b>095.520</b></p> <p><i>O.E.M. Nr.</i> <b>K 000687</b></p>		<p><i>Sampa Nr.</i> <b>095.525</b></p> <p><i>O.E.M. Nr.</i> <b>II 358510062</b></p>
<p><i>Dimension</i></p>		<p><i>Dimension</i></p>	
<p><i>Description</i></p> <p>Rep. Kit for Brake Caliper</p>		<p><i>Description</i></p> <p>Rep. Kit for Brake Caliper</p>	

*Sampa Nr.*  
**095.530**  
*O.E.M. Nr.*  
**K 001274**



*Dimension*

*Description*  
Rep. Kit for Brake Caliper

*Sampa Nr.*  
**095.531**  
*O.E.M. Nr.*  
**K 000375**



*Dimension*

*Description*  
Rep. Kit for Brake Caliper

*Sampa Nr.*  
**095.568**  
*O.E.M. Nr.*  
**K 000472**



*Dimension*

*Description*  
Rep. Kit for Brake Caliper

*Sampa Nr.*  
**095.533**  
*O.E.M. Nr.*  
**II 339680062**  
**(II 328090062)**  
**(II 369100062)**



*Dimension*

*Description*  
Rep. Kit for Brake Caliper

*Sampa Nr.*  
**095.569**  
*O.E.M. Nr.*  
**K 001925**



*Dimension*

*Description*  
Rep. Kit for Brake Caliper

*Sampa Nr.*  
**095.570**  
*O.E.M. Nr.*  
**K 001532**



*Dimension*

*Description*  
Rep. Kit for Brake Caliper









*Sampa Nr.*  
**095.526**  
*O.E.M. Nr.*  
**93161192**



*Dimension*













*Description*  
Rep. Kit for Brake Caliper

Brake

	<p><i>Sampa Nr.</i> <b>095.518</b></p> <p><i>O.E.M. Nr.</i> <b>II 368470064</b></p>		<p><i>Sampa Nr.</i> <b>095.527</b></p> <p><i>O.E.M. Nr.</i> <b>II 197140062</b></p>
<p><i>Dimension</i></p>		<p><i>Dimension</i></p>	
<p><i>Description</i></p> <p>Rep. Kit for Brake Caliper</p>		<p><i>Description</i></p> <p>Rep. Kit for Brake Caliper</p>	
	<p><i>Sampa Nr.</i> <b>095.528</b></p> <p><i>O.E.M. Nr.</i> <b>II 179320062</b></p>		<p><i>Sampa Nr.</i> <b>095.529</b></p> <p><i>O.E.M. Nr.</i> <b>II 197330062</b></p>
<p><i>Dimension</i></p>		<p><i>Dimension</i></p>	
<p><i>Description</i></p> <p>Rep. Kit for Brake Caliper</p>		<p><i>Description</i></p> <p>Rep. Kit for Brake Caliper</p>	
	<p><i>Sampa Nr.</i> <b>095.522</b></p> <p><i>O.E.M. Nr.</i> <b>II 39769F0063</b></p>		<p><i>Sampa Nr.</i> <b>095.571</b></p> <p><i>O.E.M. Nr.</i> <b>K 001301</b></p>
<p><i>Dimension</i></p>		<p><i>Dimension</i></p>	
<p><i>Description</i></p> <p>Rep. Kit for Brake Caliper</p>		<p><i>Description</i></p> <p>Rep. Kit for Brake Caliper</p>	
	<p><i>Sampa Nr.</i> <b>095.523</b></p> <p><i>O.E.M. Nr.</i> <b>K 000945</b></p>		<p><i>Sampa Nr.</i> <b>095.567</b></p> <p><i>O.E.M. Nr.</i> <b>K 000029</b></p>
<p><i>Dimension</i></p>		<p><i>Dimension</i></p>	
<p><i>Description</i></p> <p>Rep. Kit for Brake Caliper</p>		<p><i>Description</i></p> <p>Rep. Kit for Brake Caliper</p>	

## DIAPHRAGMS

R.V.I.

<p><i>Sampa Nr.</i></p> <p><b>095.101</b></p> <p><i>O.E.M. Nr.</i></p> <p>897 120 492.4</p>	 <p>Type 9" Short</p>	<p><i>Sampa Nr.</i></p> <p><b>095.108</b></p> <p><i>O.E.M. Nr.</i></p> <p>897 120 540.4</p>	 <p>Type 30" Short</p>
<p><i>Description</i></p> <p>Short Stroke</p>		<p><i>Description</i></p> <p>Short Stroke</p>	
<p><i>Sampa Nr.</i></p> <p><b>095.103</b></p> <p><i>O.E.M. Nr.</i></p> <p>897 120 505.4</p>	 <p>Type 12" Short</p>	<p><i>Sampa Nr.</i></p> <p><b>095.109</b></p> <p><i>O.E.M. Nr.</i></p> <p>897 120 550.4</p>	 <p>Type 36" Short</p>
<p><i>Description</i></p> <p>Short Stroke</p>		<p><i>Description</i></p> <p>Short Stroke</p>	
<p><i>Sampa Nr.</i></p> <p><b>095.105</b></p> <p><i>O.E.M. Nr.</i></p> <p>897 120 510.4</p>	 <p>Type 16" Short</p>	<p><i>Sampa Nr.</i></p> <p><b>095.110</b></p> <p><i>O.E.M. Nr.</i></p> <p>897 120 516.4</p>	 <p>Type 16" Long</p>
<p><i>Description</i></p> <p>Short Stroke</p>		<p><i>Description</i></p> <p>Long Stroke</p>	
<p><i>Sampa Nr.</i></p> <p><b>095.106</b></p> <p><i>O.E.M. Nr.</i></p> <p>897 120 520.4</p>	 <p>Type 20" Short</p>	<p><i>Sampa Nr.</i></p> <p><b>095.111</b></p> <p><i>O.E.M. Nr.</i></p> <p>897 120 526.4</p>	 <p>Type 20" Long</p>
<p><i>Description</i></p> <p>Short Stroke</p>		<p><i>Description</i></p> <p>Long Stroke</p>	
<p><i>Sampa Nr.</i></p> <p><b>095.107</b></p> <p><i>O.E.M. Nr.</i></p> <p>897 120 530.4</p>	 <p>Type 24" Short</p>	<p><i>Sampa Nr.</i></p> <p><b>095.112</b></p> <p><i>O.E.M. Nr.</i></p> <p>897 120 536.4</p>	 <p>Type 24" Long</p>
<p><i>Description</i></p> <p>Short Stroke</p>		<p><i>Description</i></p> <p>Long Stroke</p>	
<p><i>Sampa Nr.</i></p> <p><b>095.107</b></p> <p><i>O.E.M. Nr.</i></p> <p>897 120 530.4</p>	 <p>Type 24" Short</p>	<p><i>Sampa Nr.</i></p> <p><b>095.113</b></p> <p><i>O.E.M. Nr.</i></p> <p>897 120 546.4</p>	 <p>Type 30" Long</p>
<p><i>Description</i></p> <p>Short Stroke</p>		<p><i>Description</i></p> <p>Long Stroke</p>	

## Wheel - Axle



Sampa Nr.

**080.216**

O.E.M. Nr.

5001 852 775

Dimension

ø20xø63x72.5

Description

Silent Block

PREMIUM 6X2&6X2/4 ==>1999  
 AE MAGNUM390/420T/430/470/560  
 MAGNUM E-TECH 400/440/480  
 PREMIUM(FAB22E/H/J/Q/R)2000==>  
 PREMIUM(FAB22EE/HA/HB/JJ/QQ/RR



Sampa Nr.

**080.221**

O.E.M. Nr.

5000 682 800

Dimension

ø95xø120x24

Description

Thrust Washer

C260/290  
 R360 6X4->10/1983  
 R310 6X4 JSQ 8/1984  
 G 170/210/230/260/290  
 S130/150T/170 (VF6JP)  
 R370/390/420->1989  
 R310/330/340/365 1984->  
 M140/160/200/230  
 AE380/385T/420T/500/520  
 R 1990->1992 R 1983->  
 C230/280/300/340T/CCH-300  
 M/S 4X4 & INCENDIE  
 ME/SE/CE/160/180/210  
 MAXTER 6X4 8X4  
 M/S 150/180/210/220/230T/250  
 PS150/160  
 G230/270 SP  
 G220/270 BOM / 200/210/230T  
 G MANAGER 6X2 & 6X4 / 4X2  
 G340T TR 18T 6X6  
 PREMIUM TR 4X2 ==>1999  
 PREMIUM 6X2&6X2/4 ==>1999  
 MAXTER 4X2-4X4  
 AE MAGNUM390/420T/430/470/560

PREMIUM PR 4X2 ==> 1999  
 KERAX==>1999  
 PREMIUM 260 SP  
 MIDLUM(FAB42B1 /2-43C1/2-43T/M)  
 MAGNUM E-TECH 400/440/480  
 PREMIUM TR 4X2 2000 ==>  
 PREMIUM(FAB22E/H/J/Q/R)2000==>  
 PREMIUM PR 4X2 (FAB22A)2000==>  
 MIDLUM EXPORT (FAB 43E1-43E2)  
 KERAX FAB 33A==>S 2000==>2002  
 MIDLUM 42E3/4-44T/M/C-45D/E  
 MIDLUM 4X4 47XA/47XC  
 PREMIUM TRACTEUR 4X2(FAB 22CC)  
 PREMIUM(FAB22EE/HA/HB/JJ/QQ/RR  
 PREMIUM PR 4X2(FAB 22AA/AB)  
 KERAX (FAB 33AA.././SS)  
 KERAX (FAB33A../R) 2003==>  
 MIDLUM CCF 4X4 (FAB 47XF)  
 MACK MS200/250/300 1990->  
 MACK CS200/250/300 1990->  
 MIDLUM(FAB 42US-44US-45US)  
 SISU  
 PREMIUM 22C 071 ==> 1999



Sampa Nr.

**080.217**

O.E.M. Nr.

5010 368 906

Dimension

ø8,5/136.5x108x47.5

Description

Hub Cap

PREMIUM TR 4X2 ==>1999  
 PREMIUM 6X2&6X2/4 ==>1999  
 PREMIUM PR 4X2 ==> 1999

MAGNUM E-TECH 400/440/480  
 PREMIUM(FAB22E/H/J/Q/R)2000==>  
 PREMIUM(FAB22EE/HA/HB/JJ/QQ/RR



Sampa Nr.

**080.218**

O.E.M. Nr.

5010 368 902

Dimension

ø9/136.5x1.5

Description

Axle Gasket

PREMIUM TR 4X2 ==>1999  
 PREMIUM 6X2&6X2/4 ==>1999  
 PREMIUM PR 4X2 ==> 1999

MAGNUM E-TECH 400/440/480  
 PREMIUM(FAB22E/H/J/Q/R)2000==>  
 PREMIUM(FAB22EE/HA/HB/JJ/QQ/RR



Sampa Nr.

**080.219**

O.E.M. Nr.

7403 988 672

Dimension

M128x2/50xSW115

Description

Hub Cap

MAGNUM DXI 12-VAR-120AV  
 PREMIUM DXI 11-FAB-27JC/TC

PREMIUM DXI 11-FAB-27RC/SC



Sampa Nr.

**080.220**

O.E.M. Nr.

7420 547 252

Dimension

M112x2/50xSW115

Description

Hub Cap

MAGNUM DXI 12-VAR-120AV  
 PREMIUM DXI 11-FAB-27JC/TC

PREMIUM DXI 11-FAB-27RC/SC

Sampa Nr.

**080.060**

O.E.M. Nr.

**5010 571 187**



Dimension

ø124x52

Description

Hub Cap

PREMIUM TR 4X2 ==>1999  
 AE MAGNUM390/420TI/430/470/560  
 MAGNUM E-TECH 400/440/480  
 PREMIUM TR 4X2 2000 ==>  
 PREMIUM(FAB22E/H/J/Q/R)2000==>  
 PREMIUM PR 4X2 (FAB22A)2000==>  
 KERAX FAB 33A==>S 2000==>2002  
 MIDLUM 42B3/4-44TA/C.-45D./E.  
 PREMIUM TRACTEUR 4X2(FAB 22CC)  
 PREMIUM(FAB22EE/HA/HB/JJ/QQ/RR  
 PREMIUM PR 4X2 (FAB 22AA/AB)  
 KERAX (FAB 33AA.././SS)  
 KERAX (FAB33A.././R) 2003==>  
 SISU

Sampa Nr.

**080.067**

O.E.M. Nr.

**5010 224 222**



Dimension

SW35/47

Description

Cap

TR/GR305 "G" MANAGER 6X2 & 6X4"  
 TR/GR350 PREMIUM TR 4X2 ==>1999  
 GB131/HR15 PREMIUM 6X2&6X2/4 ==>1999  
 GB/TB191/231 MAXTER 4X2-4X4  
 GC191/231 AE MAGNUM390/420TI/430/470/560  
 GR191/231 PREMIUM PR 4X2 ==> 1999  
 GR/TR280 KERAX ==> 1999  
 R310 4X2 ->8/84 PREMIUM 260 SP  
 R360 4X2 MAGNUM E-TECH 400/440/480  
 PGC191/231 PREMIUM TR 4X2 2000 ==>  
 G260/290 PREMIUM(FAB22E/H/J/Q/R)2000==>  
 C260/290 PREMIUM PR 4X2 (FAB22A)2000==>  
 S170 (FAB=SH) MIDLUM EXPORT (FAB 43E1-43E2)  
 C210/CLR220 KERAX FAB 33A==>S 2000==>2002  
 G170 MIDLUM 42B3/4-44TA/C.-45D./E.  
 G210/230 MIDLUM 4X4 47XA/47XC  
 S130/150TI (VF6JN) PREMIUM TRACTEUR 4X2(FAB 22CC)  
 R370 JSQ 1984 PREMIUM(FAB22EE/HA/HB/JJ/QQ/RR  
 R370/390/420 ==>1989 PREMIUM PR 4X2 (FAB 22AA/AB)  
 R310/330/340/365 1984==> KERAX (FAB 33AA.././SS)  
 CBH/CLM280/340 KERAX (FAB33A.././R) 2003==>  
 G320 MIDLUM CCF 4X4 (FAB 47XF)  
 AE380/385TI/420TI/500/520 MIDLUM(FAB 42US-44US-45US)  
 MIDLINER GRANDE-BRETAGNE PREMIUM DXI 11 -FAB-27JC/TC  
 "R" 1990==>1992" "R" 1993==>" PREMIUM DXI 11 -FAB-27RC/SC  
 C230/280/300/340TI/CCH300 SISU  
 MAXTER 6X4 8X4 PREMIUM 22C 071 ==> 1999  
 "R" 1993==>"  
 G220/270 BOM  
 G200/210/230TI  
 "G" MANAGER 4X2"

Sampa Nr.

**075.065**

O.E.M. Nr.

**5000 815 713**



Dimension

M56x2xSW85

Description

Axle Nut

Sampa Nr.

**075.066**

O.E.M. Nr.

**5000 815 714**



Dimension

ø56.5xø93x4.5

Description

Lock Washer

R370/390/420==>1989 "G" MANAGER 4x2  
 R310/330/340/365 1984==> "G" MANAGER 6x2 & 6x4  
 AE380/385TI/420TI500/520 AE MAGNUM 390/420  
 "R"1990==>1992 TI/430/470/560  
 "R" 1993==>

Sampa Nr.

**030.262**

O.E.M. Nr.

**7420 399 428**



Dimension

M93x3/ø106x31

Description

Cap for Steering Knuckle

MAGNUM DXI 12 -VAR-120AV  
 PREMIUM DXI 11 -FAB-27JC/TC  
 PREMIUM DXI 11 -FAB-27RC/SC

## Wheel - Axle

	<p><b>Sampa Nr.</b> <b>080.509</b></p> <p><b>O.E.M. Nr.</b> <b>5000 793 849</b></p>		<p><b>Sampa Nr.</b> <b>080.510</b></p> <p><b>O.E.M. Nr.</b> <b>5000 793 828</b></p>
<p><b>Dimension</b> ø46x280</p>		<p><b>Dimension</b> ø40x241</p>	
<p><b>Description</b> King Pin Set</p>		<p><b>Description</b> King Pin Set</p>	
<p>GR191/231 GRH235/HF26 GRH/TRH305 GRH/TRH350 R310 4X2 -&gt;8/84 R360 4X2 GBH/TBH280 1981-&gt; GBH260/280 6X4 -&gt;1980 GLC/GLR190/230 G260/290 C260/290 R360 6X4 -&gt; 10/1983 R310 6X4 JSQ 8/1984 GLM/TLM280 C210/CLR220</p>	<p>G210/230 R370 JSQ 1984 R370/390/420 -&gt;1989 R310/330/340/365 1984-&gt; CBH/CLM280/340 G320 "R" 1990-&gt;1992" C230/280/300/340TI/CCH300 CBH/CLM 320/385 "R" 1993-&gt;" G220/270 BOM G200/210/230TI "G" MANAGER 4X2" "G" MANAGER 6X2 &amp; 6X4"</p>	<p>GC191/231 GLC/GLR190/230 G260/290 G170 G210/230 G320 M140/160/200/230 MIDLINER GRANDE-BRETAGNE C230/280/300/340TI/CCH300</p>	<p>M/S 150/180/210/220/230TI/250 G230/270 SP G220/270 BOM G200/210/230TI "G" MANAGER 4X2" "G" MANAGER 6X2 &amp; 6X4" G340TI TR 18T PG230/280</p>
	<p><b>Sampa Nr.</b> <b>080.511</b></p> <p><b>O.E.M. Nr.</b> <b>5000 794 320</b></p>		<p><b>Sampa Nr.</b> <b>080.512</b></p> <p><b>O.E.M. Nr.</b> <b>5000 336 305</b></p>
<p><b>Dimension</b> ø46x280</p>		<p><b>Dimension</b> ø35x178.5</p>	
<p><b>Description</b> King Pin Set, Single</p>		<p><b>Description</b> King Pin Set</p>	
	<p><b>Sampa Nr.</b> <b>080.511/1</b></p> <p><b>O.E.M. Nr.</b> <b>5000 794 320 S</b></p>	<p>JE13/15 JP11/13 JR/JX19/21 S170 (FAB=SH) S130/150TI/170 (VF6JP)</p>	<p>M/S 4X4 &amp; INCENDIE ME/SE/CE/ 160/180/210 PS150/160 MACK MS200/250/300 1990-&gt;&gt; MACK CS200/250/300 1990-&gt;&gt;</p>
<p><b>Dimension</b> ø46x280</p>		<p><b>Sampa Nr.</b> <b>080.514</b></p>	
<p><b>Description</b> King Pin Set, Double</p>		<p><b>O.E.M. Nr.</b> <b>5000 336 306</b></p>	
<p>GR191/231 GRH235/HF26 GRH/TRH305 GRH/TRH350 R310 4X2 -&gt;8/84 R360 4X2 GBH/TBH280 1981-&gt; GBH260/280 6X4 -&gt;1980 GLC/GLR190/230 G260/290</p>	<p>C260/290 R360 6X4 -&gt; 10/1983 R310 6X4 JSQ 8/1984 GLM/TLM280 C210/CLR220 G210/230 R370 JSQ 1984 R370/390/420 -&gt;1989 R310/330/340/365 1984-&gt; CBH/CLM280/340</p>	<p>ø30x167</p> <p><b>Description</b> King Pin Set</p> <p>JN55/60/85 S130/150TI (VF6JN) S100 MIDLINER GRANDE-BRETAGNE S140/160</p>	<p>M/S 150/180/210/220/230TI/250 PS150/160 S120/135 S135/150 (MOT 040226)</p>

Sampa Nr.

**080.516**

O.E.M. Nr.

**5000 556 940**



Dimension

M24x1.5/ø30xø38.2x257.5

Description

King Pin Set

ESSA5720  
ESSA5731  
S45/53/53RH/53RX/100/105R

Sampa Nr.

**080.517**

O.E.M. Nr.

**5000 784 185  
(5000 794 319)**



Dimension

ø40x236

Description

King Pin Set

GC191/231 G170  
TF231D G210/230  
GF151D G230/270 SP  
PGC191/231  
GLC/GLR190/230  
G260/290

Sampa Nr.

**080.533**

O.E.M. Nr.

**5000 793 641**



Dimension

ø28x153.5

Description

King Pin Set

JK55/60/65/75  
S110/130 (VF6JK)  
S100  
MIDLINER GRANDE-BRETAGNE  
S140/160  
M/S 150/180/210/220/230TI/250  
S120/135  
S135/150 (MOT 040226)

Sampa Nr.

**080.537**

O.E.M. Nr.

**0000 323 906**



Dimension

ø30x213

Description

King Pin Set

Sampa Nr.

**080.538**

O.E.M. Nr.

**5010 216 742 S**



Dimension

ø50x236

Description

King Pin Set

AE420TI  
AE520  
PREMIUM TR 4x2 2000 —>

Sampa Nr.

**080.539**

O.E.M. Nr.

**5010 056 002 S**



Dimension

ø50x225

Description

King Pin Set

G260/290  
R370/390/420 —> 1989  
AE380/385TI/420TI/500/520  
BUS TRACER  
PR112/118  
PREMIUM (6x2) (6x2/4) —> 1989  
PREMIUM (FAB 22E/H/J/Q/R) 2000 —>  
MAXTER (4x2) (4X4) (6x4) (8x4)  
KERAX

Wheel - Axle



Sampa Nr.

**080.540**

O.E.M. Nr.

5001 836 749

Dimension

ø27.5/ø28x153

Description

King Pin Set

B70  
B90  
B80/110/120



Sampa Nr.

**080.541**

O.E.M. Nr.

5000 793 360

Dimension

ø27.5/ø28x153

Description

King Pin Set

B70  
J35/48/55/60



Sampa Nr.

**080.560**

O.E.M. Nr.

5000 793 139

Dimension

ø35x224

Description

King Pin Set

GB131/HR15  
GB/TB191/231  
G260/290  
G170



Sampa Nr.

**080.561**

O.E.M. Nr.

0000 323 944

Dimension

ø35x242

Description

King Pin Set

GB131/HR15  
GB/TB191/231

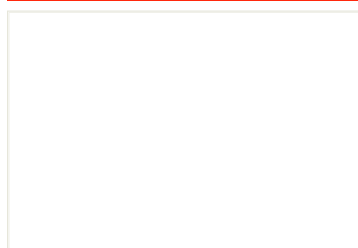

Sampa Nr.

O.E.M. Nr.

Dimension

Description

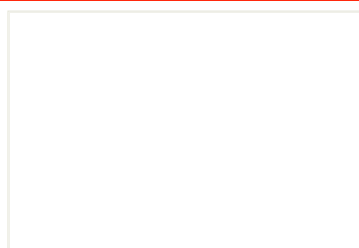

Sampa Nr.

O.E.M. Nr.

Dimension

Description

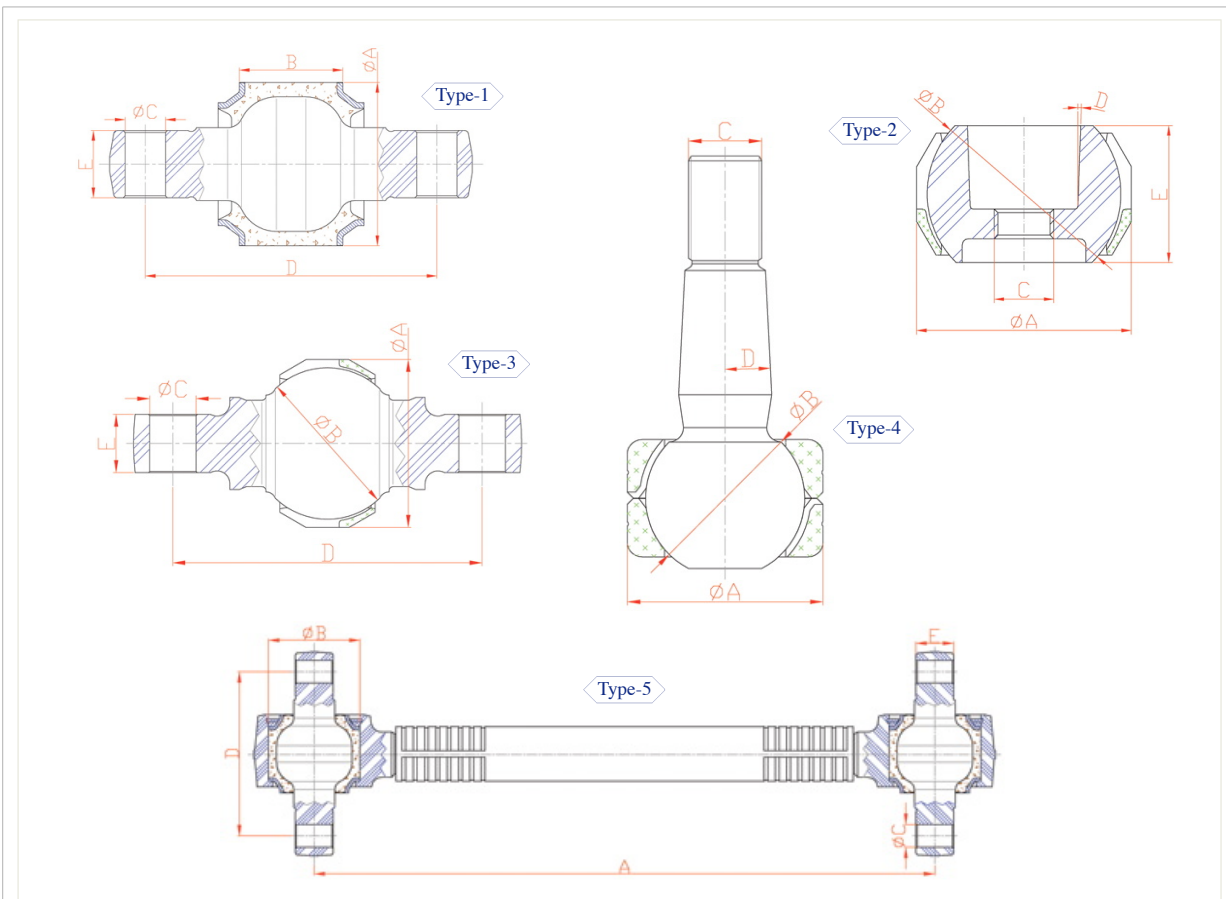

Sampa Nr.	O.E.M. Nr.	A	B	C	D	E	Repair Kit	Type
010.668	5001 836 091	ø75	48	ø19	130	24	-	1
010.578	5001 842 823	ø85	54	ø19	130	30	-	1
080.504	5000 802 123	ø85	54	ø19	145	30	-	1
080.542	5001 842 337	ø85	54	ø21	152	35	-	1
020.512	5001 014 520	ø72	ø65	M20x1.5	2°52'	46	-	2
080.507	0063 241 000	ø72	ø65	ø20	133	24	-	3
080.570	0003 404 170	ø72	ø65	ø19	145	30	-	3
010.534	0003 404 168	ø80	ø65	ø21	152	24	-	3
020.502	7701 011 267	ø80	ø65	ø19	130	30	-	3
080.505	5001 014 345	ø80	ø65	ø19	145	30	-	3
080.536	5001 832 613	ø80	ø65	M30x2	2°52'	-	-	4
080.543	5001 823 280	ø90	ø80	ø21	152	35	-	3
095.242	5010 094 839	575	ø90	ø21	152	35	080.543	5
095.243	5010 467 915	575	ø85	ø21	152	35	080.542	5
095.244	5010 094 941	575	ø80	ø19	145	30	080.505	5
095.245	5010 268 035	575	ø85	ø19	145	30	080.504	5

## V-Stay - Axle Control Arm



Sampa Nr.

**050.090**

O.E.M. Nr.

5010 294 576

*Dimension*

ø90,5x73

*Description*

Axle Rod Mounting

MAXTER 6X4 8X4  
 KERAX ==> 1999  
 KERAX FAB 33A==>S 2000==>2002  
 KERAX (FAB 33AAV.././SS)



Sampa Nr.

**080.222**

O.E.M. Nr.

5001 829 737

*Dimension*

ø17/122xø72x67/116

*Description*

Axle Rod Mounting

AE380/385TI/420TI/500/520  
 R 1993—>  
 AE MAGNUM390/420TI/430/470/560



Sampa Nr.

**080.223**

O.E.M. Nr.

5010 294 577

*Dimension*

ø21/135xø90,5x70/170

*Description*

Axle Rod Mounting

MAXTER 6X4 8X4  
 KERAX==>1999  
 KERAX FAB 33A==>S 2000==>2002  
 KERAX (FAB 33AAV.././SS)



Sampa Nr.

**010.668**

O.E.M. Nr.

5001 836 091

*Dimension*

ø75xø19x130

*Description*

Rep. Kit for Axle Rod



Sampa Nr.

**080.504**

O.E.M. Nr.

5000 802 123  
(5001 831 526)*Dimension*

ø85xø19x145

*Description*

Rep. Kit for Axle Rod

GRH/TRH305  
 GRH/TRH350



Sampa Nr.

**095.245**

O.E.M. Nr.

5010 268 035

*Dimension*

575

*Description*

Tie Rod

CBH/CLM 320/385

Sampa Nr.

**010.578**

O.E.M. Nr.

5001 842 823



Dimension

ø85xø19x130

Description

Rep. Kit for Axle Rod

Sampa Nr.

**020.512**

O.E.M. Nr.

5001 014 520



Dimension

M20x1.5/ø72x46

Description

Rep. Kit for Axle Rod

Sampa Nr.

**080.542**

O.E.M. Nr.

5001 842 337



Dimension

ø85xø21x152

Description

Rep. Kit for Axle Rod

KERAX ==> 1999  
 KERAX FAB 33A==>S 2000==>2002  
 KERAX (FAB 33AA/././SS)  
 KERAX (FAB33A/./R) 2003==>  
 KERAX 33G ARMEE BANGLADESH  
 KERAX 33K ARMEE BANGLADESH

Sampa Nr.

**080.570**

O.E.M. Nr.

0003 404 170



Dimension

ø72xø19x145

Description

Rep. Kit for Axle Rod, With Bolt

GBH260/280 6X4 —>1980

Sampa Nr.

**095.243**

O.E.M. Nr.

5010 467 915



Dimension

575

Description

Tie Rod

KERAX FAB 33A==>S 2000==>2002 )  
 KERAX (FAB 33AA/././SS)  
 KERAX (FAB33A/./R) 2003==>  
 KERAX 33G ARMEE BANGLADESH  
 KERAX 33K ARMEE BANGLADESH

Sampa Nr.

**080.570/1**

O.E.M. Nr.

5000 819 415



Dimension

ø72

Description

Rep. Kit for Axle Rod, Without Bolt

GBH260/280 6X4 —>1980

## V-Stay - Axle Control Arm



Sampa Nr.

**080.507**

O.E.M. Nr.

**0063 241 000**

Dimension

ø72xø20x133

Description

Rep. Kit for Axle Rod, With Bolt

C 38/38 T  
C 3064  
C 3464  
C 3864 R



Sampa Nr.

**080.505**

O.E.M. Nr.

**5001 014 345**

Dimension

ø80xø19x145

Description

Rep. Kit for Axle Rod, With Bolt

GBH260/280 6X6	"R" 1993—>"
CBH/CLM280/340	"G" MANAGER 6X2 & 6X4"
AE380/385TI/420TI/500/520	AE MAGNUM390/420TI/430/470/560
"R" 1990—>1992"	KERAX ==> 1999
C230/280/300/340TI/CCH300	MAGNUM E-TECH 400/440/480
CBH/CLM 320/385	KERAX FAB 33A==>S 2000==>2002



Sampa Nr.

**010.534**

O.E.M. Nr.

**0003 404 168**

Dimension

ø80xø21x152

Description

Rep. Kit for Axle Rod, With Bolt

GBH260/280 6X6  
GBH260/280 6X4 —>1980

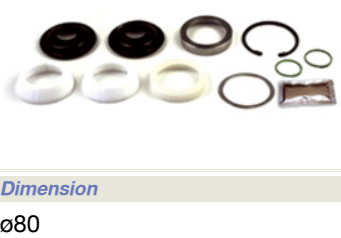

Sampa Nr.

**080.505/1**

O.E.M. Nr.

**5001 014 424**

Dimension

ø80

Description

Rep. Kit for Axle Rod, Without Bolt

GBH260/280 6X6	"R" 1993—>"
CBH/CLM280/340	"G" MANAGER 6X2 & 6X4"
AE380/385TI/420TI/500/520	AE MAGNUM390/420TI/430/470/560
"R" 1990—>1992"	KERAX ==> 1999
C230/280/300/340TI/CCH300	MAGNUM E-TECH 400/440/480
CBH/CLM 320/385	KERAX FAB 33A==>S 2000==>2002

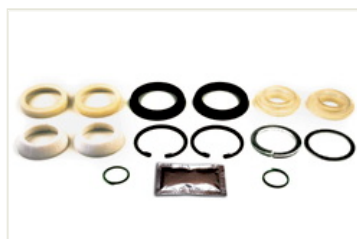

Sampa Nr.

**010.534/1**

O.E.M. Nr.

**5000 819 413**

Dimension

ø80

Description

Rep. Kit for Axle Rod, Without Bolt

GRH235/HF26	R360 6X4 —> 10/1983
GRH/TRH305	R310 6X4 JSQ 8/1984
GRH/TRH350	R370 JSQ 1984
GBH/TBH280 1981—>	R370/390/420 —>1989
GBH260/280 6X6	R310/330/340/365 1984—>
GBH260/280 6X4 —>1980	CBH/CLM280/340
G260/290	
C260/290	



Sampa Nr.

**095.244**

O.E.M. Nr.

**5010 094 941**

**(0023 123 253)**

**(5000 783 574)**

**(5010 064 641)**

**(5010 094 838)**

Dimension

575

Description

Tie Rod

GRH235/HF26	CBH/CLM280/340
GRH/TRH305	AE380/385TI/420TI/500/520
GRH/TRH350	"R" 1990—>1992"
GBH/TBH280 1981—>	C230/280/300/340TI/CCH300
GBH260/280 6X6	CBH/CLM 320/385
G260/290	"R" 1993—>"
C260/290	"G" MANAGER 6X2 & 6X4"
R360 6X4 —> 10/1983	AE MAGNUM390/420TI/430/470/560
R310 6X4 JSQ 8/1984	KERAX ==> 1999
R370 JSQ 1984	MAGNUM E-TECH 400/440/480
R370/390/420 —>1989	KERAX FAB 33A==>S 2000==>2002
R310/330/340/365 1984—>	

Sampa Nr.

**020.502**

O.E.M. Nr.

7701 011 267



Dimension

ø80xø19x130

Description

Rep. Kit for Axle Rod, With Bolt

Sampa Nr.

**080.543**

O.E.M. Nr.

5001 823 280



Dimension

ø90xø21x152

Description

Rep. Kit for Axle Rod, With Bolt

MAXTER 6X4 8X4  
G340TI 6X6  
KERAX ==> 1999  
KERAX FAB 33A==>S 2000==>2002  
KERAX (FAB 33AA/././SS)  
KERAX (FAB33A/./R) 2003==>

Sampa Nr.

**080.518**

O.E.M. Nr.

5000 819 414



Dimension

ø90

Description

Rep. Kit for Axle Rod, Without Bolt

GBH260/280 6X6  
GBH260/280 6X4 —>1980

Sampa Nr.

**080.543/1**

O.E.M. Nr.

5001 823 279



Dimension

ø90

Description

Rep. Kit for Axle Rod, Without Bolt

MAXTER 6X4 8X4  
G340TI 6X6  
KERAX ==> 1999  
KERAX FAB 33A==>S 2000==>2002  
KERAX (FAB 33AA/././SS)  
KERAX (FAB33A/./R) 2003==>

Sampa Nr.

**080.536**

O.E.M. Nr.

5001 832 613  
(4090 435 642)



Dimension

M30x2/ø80x169.5

Description

Rep. Kit for Axle Rod, With Bolt

Sampa Nr.

**095.242**

O.E.M. Nr.

5010 094 839

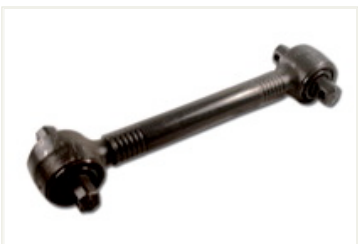

Dimension

575

Description

Tie Rod

MAXTER 6X4 8X4  
G340TI 6X6  
KERAX ==> 1999  
KERAX FAB 33A==>S 2000==>2002  
KERAX (FAB 33AA/././SS)  
KERAX (FAB33A/./R) 2003==>

## Engine - Flywheel



Sampa Nr.

**080.066**

O.E.M. Nr.

5010 130 072

Dimension

ø28xø99x65

Description

Rubber Mounting for Engine Suspension

C230/280/300/340TI/CCH300  
MAXTER 6X4 8X4  
PS150/160  
G200/210/230TI  
"G" MANAGER 4X2"  
"G" MANAGER 6X2 & 6X4"  
G340TI 6X6  
G340TI 4X4  
MAXTER 4X2-4X4  
KERAX ==> 1999  
PA200/210

PG230/280  
MIDLUM(FAB42B1/2-43C1/2-43T/V)  
MIDLUM EXPORT (FAB 43E1-43E2)  
KERAX FAB 33A==>S 2000==>2002  
KERAX (FAB 33AAV././SS)  
KERAX (FAB33A././R) 2003==>  
MACK MS200/250/300 1990—>  
MACK CS200/250/300 1990—>  
KERAX 33G ARMEE BANGLADESH  
KERAX 33K ARMEE BANGLADESH



Sampa Nr.

**080.558**

O.E.M. Nr.

Dimension

ø28xø99x65

Description

Rep. Kit for Engine Mounting

KERAX ==> 1999  
KERAX FAB 33A==>S 2000==>2002

KERAX (FAB 33AAV././SS)  
KERAX (FAB33A././R) 2003==>



Sampa Nr.

**080.131**

O.E.M. Nr.

5000 704 265

Dimension

ø27xø80x30

Description

Rubber Mounting for Engine Suspension

GBH/TBH280 1981—>  
GBH260/280 6X6  
G260/290  
GLM/TLM280  
CBH/CLM280/340  
AE380/385TI/420TI/500/520  
C230/280/300/340TI/CCH300  
MAXTER 6X4 8X4  
CBH/CLM 320/385  
PS150/160  
G200/210/230TI  
"G" MANAGER 4X2"  
"G" MANAGER 6X2 & 6X4"  
G340TI 6X6  
G340TI 4X4  
G340TI TR 18T  
PREMIUM TR 4X2 ==>1999

PREMIUM 6X2&6X2/4 ==>1999  
MAXTER 4X2-4X4  
AE MAGNUM390/420TI/430/470/560  
PREMIUM PR 4X2 ==> 1999  
KERAX ==> 1999  
PA200/210 PREMIUM 260 SP  
PG230/280  
MIDLUM(FAB42B1/2-43C1/2-43T/V)  
MIDLUM EXPORT (FAB 43E1-43E2)  
KERAX FAB 33A==>S 2000==>2002  
KERAX (FAB 33AAV././SS)  
KERAX (FAB33A././R) 2003==>  
MACK MS200/250/300 1990—>  
MACK CS200/250/300 1990—>  
KERAX 33G ARMEE BANGLADESH  
KERAX 33K ARMEE BANGLADESH



Sampa Nr.

**080.100**

O.E.M. Nr.

5010 239 498

Dimension

ø28xø106x64

Description

Rubber Mounting for Engine Suspension

AE380/385TI/420TI/500/520  
G340TI TR 18T  
PREMIUM TR 4X2 ==>1999  
PREMIUM 6X2&6X2/4 ==>1999

AE MAGNUM390/420TI/430/470/560  
PREMIUM PR 4X2 ==> 1999  
PREMIUM 260 SP



Sampa Nr.

**080.552**

O.E.M. Nr.

Dimension

ø28xø106x64

Description

Rep. Kit for Engine Mounting

AE380/385TI/420TI/500/520  
AE MAGNUM390/420TI/430/470/560

Sampa Nr.

O.E.M. Nr.

Dimension

Description

Sampa Nr.

**080.131**

O.E.M. Nr.

**5000 704 265**



**Dimension**  
ø27xø80x30

**Description**

Rubber Mounting for Engine Suspension

GBH/TBH280 1981—>	PREMIUM 6X2&6X2/4 ==>1999
GBH260/280 6X6	MAXTER 4X2-4X4
G260/290	AE MAGNUM390/420TI/430/470/560
GLM/TLM280	PREMIUM PR 4X2 ==> 1999
CBH/CLM280/340	KERAX ==> 1999
AE380/385TI/420TI/500/520	PA200/210 PREMIUM 260 SP
C230/280/300/340TI/CCH300	PG230/280
MAXTER 6X4 8X4	MIDLUM(FAB42B1/2-43C1/2-43T/V)
CBH/CLM 320/385	MIDLUM EXPORT (FAB 43E1-43E2)
PS150/160	KERAX FAB 33A==>S 2000==>2002
G200/210/230TI	KERAX (FAB 33AA/././SS)
"G" MANAGER 4X2"	KERAX (FAB33A/././R) 2003==>
"G" MANAGER 6X2 & 6X4"	MACK MS200/250/300 1990—>
G340TI 6X6	MACK CS200/250/300 1990—>
G340TI 4X4	KERAX 33G ARMEE BANGLADESH
G340TI TR 18T	KERAX 33K ARMEE BANGLADESH
PREMIUM TR 4X2 ==>1999	

Sampa Nr.

**080.155**

O.E.M. Nr.

**5000 704 264**



**Dimension**  
ø27.5xø100x64

**Description**

Rubber Mounting for Engine Suspension

GBH/TBH280 1981—>	CBH/CLM280/340
GBH260/280 6X6	CBH/CLM 320/385
G260/290	"G" MANAGER 4X2"
GLM/TLM280	"G" MANAGER 6X2 & 6X4"

Sampa Nr.

**080.575**

O.E.M. Nr.



**Dimension**  
ø27.5xø100x64

**Description**

Rep. Kit for Engine Mounting

GBH/TBH280 1981—>	GLM/TLM280
GBH260/280 6X6	CBH/CLM280/340

Sampa Nr.

**080.065**

O.E.M. Nr.

**5010 094 716**



**Dimension**  
M20x2.5/97/70 ShA

**Description**

Engine Mounting

CBH/CLM280/340  
AE380/385TI/420TI/500/520  
CBH/CLM 320/385  
AE MAGNUM390/420TI/430/470/560  
MAGNUM E-TECH 400/440/480  
SISU

Sampa Nr.

**080.138**

O.E.M. Nr.

**5010 130 602**



**Dimension**  
M20x2.5/97/50 ShA

**Description**

Engine Mounting

AE380/385TI/420TI/500/520  
AE MAGNUM390/420TI/430/470/560

Sampa Nr.

**080.068**

O.E.M. Nr.

**5010 316 158**



**Dimension**  
159x255x95

**Description**

Engine Mounting

AE MAGNUM390/420TI/430/470/560  
MAGNUM E-TECH 400/440/480  
SISU

## Engine - Flywheel



Sampa Nr.

**080.069**

O.E.M. Nr.

**5010 316 680**

Dimension

132x369x130

Description

Engine Mounting, Left

PREMIUM TR 4X2 2000 ==>  
 PREMIUM(FAB22E/H/J/Q/R)2000==>  
 PREMIUM TRACTEUR 4X2(FAB 22CC)  
 PREMIUM(FAB22EE/HA/HB/JJ/QQ/RR)  
 PREMIUM PR 4X2 (FAB 22AA/AB)  
 PREMIUM 22C 071 ==> 1999



Sampa Nr.

**080.070**

O.E.M. Nr.

**5010 316 681**

Dimension

132x369x130

Description

Engine Mounting, Right

PREMIUM TR 4X2 2000 ==>  
 PREMIUM(FAB22E/H/J/Q/R)2000==>  
 PREMIUM TRACTEUR 4X2(FAB 22CC)  
 PREMIUM(FAB22EE/HA/HB/JJ/QQ/RR)  
 PREMIUM PR 4X2 (FAB 22AA/AB)  
 PREMIUM 22C 071 ==> 1999



Sampa Nr.

**080.072**

O.E.M. Nr.

**5010 460 352**

Dimension

132x369x130

Description

Engine Mounting, Right

PREMIUM TR 4X2 2000 ==>  
 PREMIUM(FAB22E/H/J/Q/R)2000==>  
 PREMIUM PR 4X2 (FAB22A)2000==>

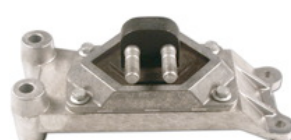

Sampa Nr.

**080.151**

O.E.M. Nr.

**5010 460 351**

Dimension

132x369x130

Description

Engine Mounting, Left

PREMIUM TR 4X2 2000 ==>  
 PREMIUM(FAB22E/H/J/Q/R)2000==>  
 PREMIUM PR 4X2 (FAB22A)2000==>

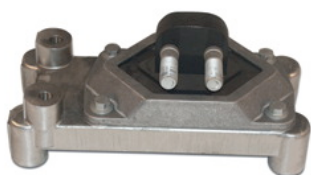

Sampa Nr.

**080.170**

O.E.M. Nr.

**5010 460 353**

Dimension

150x315x155

Description

Engine Mounting, Left

PREMIUM PR 4X2 ==> 1999  
 PREMIUM 260 SP  
 PREMIUM PR 4X2 (FAB22A)2000==>



Sampa Nr.

**080.171**

O.E.M. Nr.

**5010 460 354**

Dimension

150x315x155

Description

Engine Mounting, Right

PREMIUM PR 4X2 ==> 1999  
 PREMIUM 260 SP  
 PREMIUM PR 4X2 (FAB22A)2000==>

Sampa Nr.

**080.172**

O.E.M. Nr.

**5010 460 240**

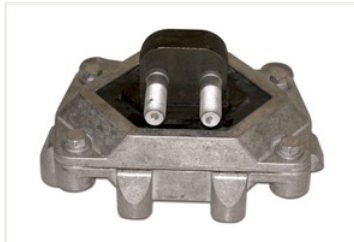

Dimension

180x250x140

Description

Engine Mounting, Left

KERAX(FAB 33AA.././SS)

Sampa Nr.

**080.173**

O.E.M. Nr.

**5010 460 241**



Dimension

180x250x140

Description

Engine Mounting, Right

KERAX(FAB 33AA.././SS)

Sampa Nr.

**080.162**

O.E.M. Nr.

**5010 316 591**



Dimension

ø20/160x106

Description

Engine Mounting, Left

PREMIUM TR 4X2 2000 ==>  
PREMIUM TRACTEUR 4X2(FAB 22CC)  
PREMIUM(FAB22EE/HA/HB/JJ/QQ/RR)  
PREMIUM PR 4X2 (FAB 22AA/AB)  
PREMIUM 22C 071 ==> 1999

Sampa Nr.

**080.163**

O.E.M. Nr.

**5010 316 592**



Dimension

ø20/160x106

Description

Engine Mounting, Right

PREMIUM TR 4X2 2000 ==>  
PREMIUM TRACTEUR 4X2(FAB 22CC)  
PREMIUM(FAB22EE/HA/HB/JJ/QQ/RR)  
PREMIUM PR 4X2 (FAB 22AA/AB)  
PREMIUM 22C 071 ==> 1999

Sampa Nr.

**080.164**

O.E.M. Nr.

**5010 316 521**



Dimension

ø20/160x106

Description

Engine Mounting, Left

PREMIUM TR 4X2 ==>1999  
PREMIUM 6X2&6X2/4 ==>1999  
PREMIUM PR 4X2 ==> 1999  
PREMIUM 260 SP  
PREMIUM TR 4X2 2000 ==>  
PREMIUM(FAB22E/H/J/Q/R)2000==>  
PREMIUM PR 4X2 (FAB22A)2000==>  
PREMIUM 22C 071 ==> 1999

Sampa Nr.

**080.165**

O.E.M. Nr.

**5010 316 522**



Dimension

ø20/160x106

Description

Engine Mounting, Right

PREMIUM TR 4X2 ==>1999  
PREMIUM 6X2&6X2/4 ==>1999  
PREMIUM PR 4X2 ==> 1999  
PREMIUM 260 SP  
PREMIUM TR 4X2 2000 ==>  
PREMIUM(FAB22E/H/J/Q/R)2000==>  
PREMIUM PR 4X2 (FAB22A)2000==>  
PREMIUM 22C 071 ==> 1999

## Engine - Flywheel



Sampa Nr.

**080.166**

O.E.M. Nr.

**5010 460 294**

Dimension

ø20/160x106

Description

Engine Mounting, Left

PREMIUM TR 4X2 2000 ==>  
 PREMIUM(FAB22E/H/J/Q/R)2000==>  
 PREMIUM TRACTEUR 4X2(FAB 22CC)  
 PREMIUM(FAB22EE/HA/HB/JJ/QQ/RR)  
 PREMIUM PR 4X2 (FAB 22AA/AB)



Sampa Nr.

**080.167**

O.E.M. Nr.

**5010 460 295**

Dimension

ø20/160x116

Description

Engine Mounting, Right

PREMIUM TR 4X2 2000 ==>  
 PREMIUM(FAB22E/H/J/Q/R)2000==>  
 PREMIUM TRACTEUR 4X2(FAB 22CC)  
 PREMIUM(FAB22EE/HA/HB/JJ/QQ/RR)  
 PREMIUM PR 4X2 (FAB 22AA/AB)



Sampa Nr.

**080.168**

O.E.M. Nr.

**5010 316 573**

Dimension

ø20/160x106

Description

Engine Mounting, Left

PREMIUM PR 4X2==> 1999  
 PREMIUM PR 4X2(FAB22A)2000==>



Sampa Nr.

**080.169**

O.E.M. Nr.

**5010 316 574**

Dimension

ø20/160x106

Description

Engine Mounting, Right

PREMIUM PR 4X2==> 1999  
 PREMIUM PR 4X2(FAB22A)2000==>



Sampa Nr.

**080.071**

O.E.M. Nr.

**5010 316 876**

Dimension

M10/M12x46

Description

Engine Mounting

MIDLINER GRANDE-BRETAGNE MACK MS200/250/300 1990—>  
 MS 4X4 & INCENDIE MACK CS200/250/300 1990—>  
 MS 150/180/210/220/230TI/250  
 S135/150 (MOT 040226)  
 MS300 SUDAMERICA  
 MIDLUM(FAB42B1/2-43C1/2-43T/V)  
 MIDLUM EXPORT (FAB 43E1-43E2)

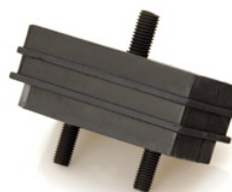

Sampa Nr.

**080.148**

O.E.M. Nr.

**5010 467 526**

Dimension

M10/M12x46

Description

Engine Mounting

MAXTER 6X4 8X4  
 "G" MANAGER 4X2"  
 "G" MANAGER 6X2 & 6X4"  
 G340TI 6X6  
 G340TI 4X4  
 MAXTER 4X2-4X4  
 KERAX ==> 1999

KERAX FAB 33A==>S 2000==>2002  
 KERAX (FAB33A././R) 2003==>  
 KERAX 33G ARMEE BANGLADESH  
 KERAX 33K ARMEE BANGLADESH

**Sampa Nr.**  
**080.116**

**O.E.M. Nr.**  
**5000 748 630**



**Dimension**  
ø16x72

**Description**  
Engine Mounting

TR/GR305 R310/330/340/365 1984—>  
GR/TR280 "R" 1990—>1992  
GRH/TRH305 "R" 1993—>  
R310 4X2 ->8/84  
R310 6X4 JSQ 8/1984

**Sampa Nr.**  
**080.161**

**O.E.M. Nr.**  
**5000 788 730**



**Dimension**  
ø19/ø35xø62/ø75x79.5

**Description**  
Engine Mounting

TR/GR305 GLR230 4X4 SINPAR  
GR/TR280 R370/390/420->1989  
GRH/TRH305 R310/330/340/365 1984—>  
R310 4X2—>8/84 R 1990—>1992  
GLC/GLR190/230 R 1993—>  
R310 6X4 JSQ 8/1984

**Sampa Nr.**  
**080.174**

**O.E.M. Nr.**  
**5000 750 515**



**Dimension**  
ø22.5xø75x90

**Description**  
Engine Mounting

GB131/HR15 M140/160/200/230  
GF151D MIDLINER GRANDE-BRETAGNE  
PJK/PJN/PJP S140/160  
JE13/15 M/S 4X4 & INCENDIE  
JN55/60/85 ME/SE/CE/160/180/210  
JP11/13 M/S 150/180/210/220/230TI/250  
JK55/60/65/75 PS150/160  
JR/JX19/21 G200/210/230TI  
S170 (FAB=SH) M210 4X4  
J&S4X4->5/1991 MS300 SUDAMERICA  
G170 MIDLUM(FAB42B1 /2-43C1 /2-43T/V)  
S130/150TI (VF6JN) MIDLUM EXPORT (FAB 43E1-43E2)  
S130/150TI/170 (VF6JP) MACK MS200/250/300 1990—>  
S110/130(VF6JK) MACK CS200/250/300 1990—>

**Sampa Nr.**  
**080.248**

**O.E.M. Nr.**  
-



**Dimension**  
ø16/ø32x58/70 ShA

**Description**  
Engine Mounting

**Sampa Nr.**  
**080.255**

**O.E.M. Nr.**  
**0945 331 007**



**Dimension**  
ø16/ø32x58/60 ShA

**Description**  
Engine Mounting

GB/TB191/231	GLC/GLR190/230	G230/270 SP
GC191/231	G260/290	G220/270 BOM
GR191/231	GLR230 4X4 SINPAR	G MANAGER 4X2
GRH235/HF26	G210/230	G MANAGER 6X2 &
TF231D	770KB6 SP	6X4
PGC191/231	G320	PG230/280

**Sampa Nr.**  
**080.251**

**O.E.M. Nr.**  
**0000 250 074**



**Dimension**  
ø30xø86x120

**Description**  
Engine Mounting

**Sampa Nr.**  
**080.254**

**O.E.M. Nr.**  
**0000 482 344**



**Dimension**  
ø100xø130x130

**Description**  
Filter Hose

GBH260/280 6X4 —>1980

# Propeller Shaft - Clutch



Sampa Nr.

**080.123**

O.E.M. Nr.

**5000 589 888**

Dimension

ø50

Description

Propeller Shaft Bearing

TR/GR305	R310 4X2 ->8/84	G170
GR191/231	G260/290	G210/230
GR/TR280	C260/290	



Sampa Nr.

**080.139**

O.E.M. Nr.

**5000 242 914**

Dimension

ø45

Description

Propeller Shaft Bearing

GB131/HR15	C210/CLR220
GB/TB191/231	G170
GC191/231	G210/230
GR191/231	S130/150TI/170 (VF6JP)
GF151D	M140/160/200/230
PJK/PJN/PJP	MIDLINER GRANDE-BRETAGNE
PGC191/231	S140/160
GLC/GLR190/230	C230/280/300/340TI/CCH300
JE13/15	ME/SE/CE/ 160/180/210
C260/290	PS150/160
JP11/13	S120/135
JR/JX19/21	S135/150 (MOT 040226)
S170 (FAB=SH)	MIDLUM(FAB42B1/2-43C1/2-43T/V)
GLR230 4X4 SINPAR	



Sampa Nr.

**080.056**

O.E.M. Nr.

**5000 677 320**

Dimension

M16x2/ø44x60

Description

Ball Joint

GBH/TBH280 1981—>	MAXTER 6X4 8X4
GBH260/280 6X6	CBH/CLM 320/385
G260/290	"R" 1993—>
C260/290	G230/270 SP
GLM/TLM280	G220/270 BOM
R370/390/420 —>1989	"G" MANAGER 4X2"
R310/330/340/365 1984—>	"G" MANAGER 6X2 & 6X4"
CBH/CLM280/340	G340TI 6X6
G320	G340TI 4X4
AE380/385TI/420TI/500/520	G340TI TR 18T
"R" 1990—>1992"	MAXTER 4X2-4X4
C230/280/300/340TI/CCH300	PG230/280



Sampa Nr.

**080.057**

O.E.M. Nr.

**5000 787 873**

Dimension

ø44x17

Description

Ball Joint Bearing

R310 4X2 ->8/84
R360 4X2
GBH/TBH280 1981—>
GBH260/280 6X6
G260/290
C260/290
R360 6X4 —> 10/1983
R310 6X4 JSQ 8/1984
GLM/TLM280
R370 JSQ 1984
R370/390/420 —>1989
R310/330/340/365 1984—>
CBH/CLM280/340
G320
AE380/385TI/420TI/500/520
"R" 1990—>1992"
C230/280/300/340TI/CCH300
MAXTER 6X4 8X4
CBH/CLM 320/385
"R" 1993—>
G230/270 SP
G220/270 BOM
"G" MANAGER 4X2"
"G" MANAGER 6X2 & 6X4"
G340TI 6X6
G340TI 4X4
G340TI TR 18T
MAXTER 4X2-4X4
PG230/280

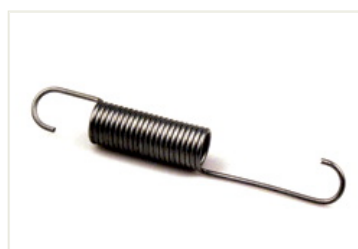

Sampa Nr.

**080.230**

O.E.M. Nr.

**0000 165 918**

Dimension

ø20x145

Description

Return Spring

TR/GR305	GBH/TBH280 1981—>
TR/GR350	PGC191/231
GB/TB191/231	GBH260/280 6X6
GC191/231	GBH260/280 6X4->1980
GR191/231	GLC/GLR190/230
GRH235/HF26	R360 6X4->10/1983
GR/TR280	R310 6X4 JSQ 8/1984
GRH/TRH305	GLM/TLM280
GRH/TRH350	GLR230 4X4 SINPAR
TF231D	770KB6 SP
R310 4X2—>8/84	G230/270 SP
R360 4X2	

Sampa Nr.

**080.153**

O.E.M. Nr.

**0023 535 072**



Dimension

M14/ø80x66

Description

Gearbox Mounting

GR/TR280	G260/290
GBH/TBH280 1981—>	GLM/TLM280
GBH260/280 6X6	CBH/CLM280/340
GBH260/280 6X4 —>1980	CBH/CLM 320/385

Sampa Nr.

**080.076**

O.E.M. Nr.

**5010 242 799**

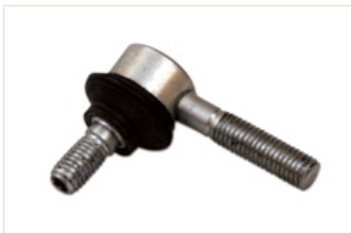

Dimension

M10x1.5

Description

Ball Joint

G210/230/260/290/320	AE MAGNUM390/420TI/430/470/560
AE380/385TI/420TI/500/520	PREMIUM PR 4X2 ==> 1999
"R" 1990—>1992"	KERAX ==> 1999
MAXTER 4X2-4X4-6X4-8X4	PG230/280
M/S 150/180/210/220/230TI/250	MIDLUM(FAB42B1/2-43C1/2-43T/V)
"R" 1993—>	PREMIUM TR 4X2 2000 ==>
G220/270 BOM	PREMIUM(FAB22E/H/J/Q/R)2000==>
G200/210/230TI	PREMIUM PR 4X2 (FAB22A)2000==>
"G" MANAGER "4X2 & 6X2 & 6X4"	MIDLUM EXPORT (FAB 43E1-43E2)
G340TI 6X6 / 4x4	MIDLUM 42B3/4-44T/V/C.-45D/E.
G340TI TR 18T	MACK MS200/250/300 1990—>
PREMIUM TR 4X2 ==>1999	SISU
PREMIUM 6X2&6X2/4 ==>1999	PREMIUM 22C 071 ==> 1999

Sampa Nr.

**080.077**

O.E.M. Nr.

**5010 245 591**

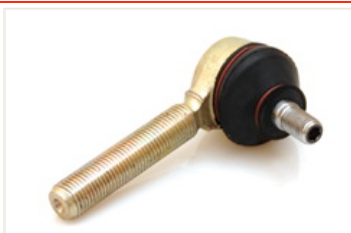

Dimension

M10x1.25/M14x1.5

Description

Ball Joint

PREMIUM TR 4X2 ==>1999	KERAX FAB 33A==>S 2000==>2002
PREMIUM 6X2&6X2/4 ==>1999	MIDLUM 42B3/4-44TA/V/C.-45D/E.
AE MAGNUM390/420TI/430/470/560	MIDLUM 4X4 47XA/47XC
PREMIUM PR 4X2 ==> 1999	PREMIUM TRACTEUR 4X2(FAB 22CC)
KERAX ==> 1999	PREMIUM(FAB22EE/HA/HB/JJ/QQ/RR)
PA 200/210	PREMIUM PR 4X2 (FAB 22AA/AB)
PREMIUM 260 SP	KERAX (FAB 33AA/././SS)
MIDLUM(FAB42B1/2-43C1/2-43T/V)	KERAX (FAB33A/././R) 2003==>
PREMIUM TR 4X2 2000 ==>	MIDLUM(FAB 42US-44US-45US)
PREMIUM(FAB22E/H/J/Q/R)2000==>	KERAX 33G / 33K ARMEE
PREMIUM PR 4X2 (FAB22A)2000==>	BANGLADESH
MIDLUM EXPORT (FAB 43E1-43E2)	

Sampa Nr.

**080.224**

O.E.M. Nr.

**5000 750 738**



Dimension

ø18xø56x70

Description

Silent Block for Gearbox

KERAX	G MANAGER
PREMIUM	MAXTER
MAGNUM	G260/290

Sampa Nr.

**080.225**

O.E.M. Nr.

**5010 377 555**



Dimension

ø18xø56x70

Description

Silent Block for Gearbox

PG230/280	PREMIUM
-----------	---------

Sampa Nr.

**080.064**

O.E.M. Nr.

**5000 750 630**



Dimension

M10/ø49x35.5

Description

Rubber Mounting for Exhaust

C260/290	C230/280/300/340TI/CCH300
C210/CLR220	PREMIUM

Sampa Nr.

**080.250**

O.E.M. Nr.

**0000 689 778**



Dimension

ø15xø50x20

Description

Rubber Mounting for Exhaust

TR/GR305	R310 4X2—>8/84	R360 6X4->10/1983
TR/GR350	R360 4X2	R310 6X4 JSQ 8/1984
GR/TR280	GBH/TBH280 1981—>	
GRH/TRH305	GBH260/280 6X6	
GRH/TRH350	G260/290	

# Shock Absorber



Sampa Nr.

**080.038**

O.E.M. Nr.

-

Dimension

660 mm/350N

Description

Gas Spring



Sampa Nr.

**080.232**

O.E.M. Nr.

**5010 227 221**  
**(5010 445 375)**

Dimension

405mm/150N

Description

Gas Spring

AE380/385TI/420TI/500/520  
AE MAGNUM390/420TI/430/470/560  
MAGNUM E-TECH 400/440/480  
MAGNUM DX112 -VAR-120AV



Sampa Nr.

**080.233**

O.E.M. Nr.

**5010 290 528**  
**(5010 445 244)**

Dimension

235mm/250N

Description

Gas Spring

PREMIUM TR 4X2 ==>1999	KERAX FAB 33A==>S 2000==>2002
PREMIUM 6X2&6X2/4==>1999	PREMIUM TRACTEUR 4X2(FAB 22CC)
PREMIUM PR 4X2 ==> 1999	PREMIUM(FAB22EE/HA/HB/JJ/QQ/RR
KERAX==>1999	PREMIUM PR 4X2 (FAB 22AA/AB)
SISU	KERAX (FAB 33AA.././SS)
PREMIUM 22C 071 ==> 1999	KERAX (FAB33A.././R) 2003==>
PREMIUM TR 4X2 2000 ==>	PREMIUM DXI 11 -FAB-27JC/TC
PREMIUM(FAB22E/H/J/Q/R)2000==>	PREMIUM DXI 11 -FAB-27RC/SC
PREMIUM PR 4X2 (FAB22A)2000==>	



Sampa Nr.

**080.234**

O.E.M. Nr.

**5010 353 703**

Dimension

635mm/200N

Description

Gas Spring

PREMIUM TR 4X2==>1999  
PREMIUM 6X2&6X2/4 ==>1999  
PREMIUM PR 4X2==> 1999  
KERAX==>1999  
PREMIUM 260 SP  
PREMIUM TR 4X2 2000 ==>  
PREMIUM(FAB22E/H/J/Q/R)2000—>  
PREMIUM PR 4X2(FAB22A)2000==>  
KERAX FAB 33A==>S 2000==>2002



Sampa Nr.

**080.235**

O.E.M. Nr.

**5010 225 922**

Dimension

635mm/350N

Description

Gas Spring

PREMIUM TR 4X2 ==>1999	PREMIUM PR 4X2 ==> 1999
PREMIUM 6X2&6X2/4==>1999	



Sampa Nr.

**080.236**

O.E.M. Nr.

**5010 468 003**

Dimension

615mm/230N

Description

Gas Spring

PREMIUM 260 SP  
PREMIUM TR 4X2 2000 ==>  
PREMIUM(FAB22E/H/J/Q/R)2000==>  
PREMIUM PR 4X2 (FAB22A)2000==>  
KERAX FAB 33A==>S 2000==>2002  
PREMIUM TRACTEUR 4X2(FAB 22CC)  
PREMIUM(FAB22EE/HA/HB/JJ/QQ/RR  
PREMIUM PR 4X2 (FAB 22AA/AB)  
KERAX (FAB 33AA.././SS)  
KERAX (FAB33A.././R) 2003==>  
SISU

Sampa Nr.

**080.237**

O.E.M. Nr.

5010 578 586



Dimension

630mm/400N

Description

Gas Spring

PREMIUM DXI 11-FAB-27RC/SC PREMIUM DXI 11-FAB-27JC/TC

Sampa Nr.

**080.073**

O.E.M. Nr.

5010 377 224



Dimension

M12/ø39x28

Description

Rubber Mounting for Air Suspension

AE380/385TI/420TI/500/520 MAGNUM E-TECH 400/440/480  
AE MAGNUM390/420TI/430/470/560

Sampa Nr.

**080.074**

O.E.M. Nr.

5010 570 047



Dimension

M10/ø39x28.5

Description

Rubber Mounting for Radiator

GB/TB191/231	G230/270 SP
GC191/231	G220/270 BOM
GR191/231	G200/210/230TI
GRH235/HF26	"G" MANAGER 4X2 & 6X2 & 6X4
SG2 DEP 1979	G340TI 4X4 6X6
PGC191/231	G340TI TR 18T
GBH260/280 6X6	PREMIUM TR 4X2 ==>1999
GBH260/280 6X4 -->1980	PREMIUM 6X2&6X2/4 ==>1999
G170/210/230/260/290/320	MAXTER 4X2-4X4
S130/150TI (VF6JN)	AE MAGNUM390/420TI/430/470/560
S130/150TI/170 (VF6JP)	PREMIUM PR 4X2 ==> 1999
770KB6 SP	S135/150 (MOT 040226)
F310/330/340/365 1984-->	M210 4X4
SG4 / SG3	KERAX ==> 1999
S100/110/130 (VF6JK)	PA200/210 / PG230/280
M140/160/200/230	PREMIUM 260 SP
AE380/385TI/420TI/500/520	MIDLUM(FAB42B1/2-43C1/2-43T/M)
"R"1990-->1992 / "R" 1993-->	MAGNUM E-TECH 400/440/480
S120/135/140/160	PREMIUM TR 4X2 ==>
M/S 4X4 & INCENDIE	PREMIUM(FAB22E/H/J/Q/R)2000==>
ME/SE/CE/ 160/180/210	PREMIUM PR 4X2 (FAB22A)2000==>
MAXTER 6X4 8X4	MIDLUM EXPORT (FAB 43E1-43E2)
M/S 150/180/210/220/230TI/250	KERAX FAB 33A==>S 2000==>2002
PS150/160	MIDLUM 42B3/4-44TA/C.-45D/E.

Sampa Nr.

**030.229**

O.E.M. Nr.

5001 835 165



Dimension

ø19xø50.5x26

Description

Rubber Bushing for Shock Absorber

AE380/385TI/420TI/500/520  
G340TI TR 18T  
PREMIUM TR 4X2 ==>1999  
PREMIUM 6X2&6X2/4 ==>1999  
AE MAGNUM390/420TI/430/470/560  
PREMIUM PR 4X2 ==> 1999  
KERAX ==> 1999  
PREMIUM 260 SP  
PG230/280  
MAGNUM E-TECH 400/440/480  
PREMIUM TR 4X2 2000 ==>  
PREMIUM(FAB22E/H/J/Q/R)2000==>  
KERAX FAB 33A==>S 2000==>2002  
PREMIUM 22C 071 ==> 1999

Sampa Nr.

**080.147**

O.E.M. Nr.

5000 739 051



Dimension

M16/ø100x73

Description

Rubber Mounting for Air Suspension

GLC/GLR190/230	CBH/CLM280/340
JE13/15	C230/280/300/340TI/CCH300
C260/290	ME/SE/CE/ 160/180/210
GLR230 4X4 SINPAR	CBH/CLM 320/385
C210/CLR220	MACK CS200/250/300 1990-->

Sampa Nr.

**080.252**

O.E.M. Nr.

5000 418 144



Dimension

ø20xø42x42

Description

Rubber Mounting for Radiator

C260/290 C210/CLR220

**Filler / Pedal / Gas**



Sampa Nr.

**080.055**

O.E.M. Nr.

**0000 149 310**

Dimension

ø37xø54.5x31

Description

Filler Cap

TR/GR305/350	C210/CLR220
GB131/HR15	G170/210/230/260/290/320
GB/TB191/231	R370 JSQ 1984
GC191/231	770KB6 SP
GR191/231	R370/390/420 →1989
GRH235/HF26	R310/330/340/365 1984→
GR/TR280	CBH/CLM280/340
GRH/TRH305/350	M140/160/200/230
TF231D	AE380/385TI/420TI/500/520
GF151D	"R" 1990→1992"
R310 4X2 ->8/84	PREMIUM
R360 4X2	MAGNUM
PGC191/231	MIDLUM
GLC/GLR190/230	KERAX
JE13/15	MAXTER
C260/290	
R360 6X4 → 10/1983	
R310 6X4 JSQ 8/1984	
GLR230 4X4 SINPAR	



Sampa Nr.

**080.150**

O.E.M. Nr.

**0000 270 526**

Dimension

ø14.7x76.5

Description

Return Spring

GB/TB191/231	CBH/CLM 320/385
GC191/231	M/S 150/180/210/220/230TI/250
GR191/231	PS150/160
GRH235/HF26	"R" 1993→
TF231D	G230/270 SP
R310 4X2 ->8/84	G220/270 BOM
GBH/TBH280 1981→	G200/210/230TI
PGC191/231	"G" MANAGER 4X2"
GBH260/280 6X6	"G" MANAGER 6X2 & 6X4"
GLC/GLR190/230	G340TI 4X4/ 6X6
G260/290	G340TI TR 18T
R310 6X4 JSQ 8/1984	PREMIUM TR 4X2 ==>1999
GLM/TLM280	PREMIUM 6X2&6X2/4 ==>1999
GLR230 4X4 SINPAR	MAXTER 4X2-4X4
G170/210/230/320	AE MAGNUM390/420TI/430/470/560
R370 JSQ 1984	PREMIUM PR 4X2 ==> 1999
770KB6 SP	KERAX ==> 1999
R370/390/420 →1989	PREMIUM 260 SP
R310/330/340/365 1984→	PG230/280
CBH/CLM280/340	MIDLUM(FAB42B1/2-43C1/2-43T/V)
AE380/385TI/420TI/500/520	PREMIUM PR 4X2 (FAB22A)2000==>
"R" 1990→1992"	MACK CS200/250/300 1990→
C230/280/300/340TI/CCH300	
M/S 4X4 & INCENDIE	
MAXTER 6X4 8X4	



Sampa Nr.

**080.257**

O.E.M. Nr.

**7700 693 776**

Dimension

ø12x59

Description

Idle Speed Adjustment

GBH/TBH280 1981→	C230/280/300/340TI/CCH300
GBH260y280 6X6	MAXTER 6X4 8X4
JE13/15	CBH/CLM 320/385
C260/290	R 1993→
GLM/TLM280	G230/270 SP
C210/CLR220	G220/270 BOM
G170/210/230/260/290/320	G200/210/230TI
S130/150TI (VF6JN)	G MANAGER 4X2 & 6X2 & 6X4
S130/150TI/170 (VF6JP)	G340TI 4X4 & 6X6
R370/390/420->1989	PREMIUM
R310/330/340/365 1984→	MAXTER
CBH/CLM280/340	KERAX
AE380/385TI/420TI/500/520	MIDLUM
R 1990→1992	SISU



Sampa Nr.

**080.061**

O.E.M. Nr.

**5516 031 803**

Dimension

M73x4/48

Description

Filler Cap

GB131/HR15	R310/330/340/365 1984→
GB/TB191/231	S100/110/130 (VF6JK)
GC191/231	CBH/CLM280/340
GR191/231	M140/160/200/230
GRH235/HF26	AE380/385TI/420TI/500/520
TF231D	MIDLINER GRANDE-BRETAGNE
GF151D	"R" 1990→1992"
PJK/PJN/PJP	S140/160
PGC191/231	C230/280/300/340TI/CCH300
JE13/15	M/S 4X4 & INCENDIE
G260/290	ME/SE/CE/ 160/180/210
C260/290	MAXTER 6X4 8X4
JN55/60/85	CBH/CLM 320/385
JP11/13	M/S 150/180/210/220/230TI/250
JK55/60/65/75	"R" 1993→
S170 (FAB=SH)	S120/135
C210/CLR220	G220/270 BOM
G170/210/230/320	G200/210/230TI
S130/150TI (VF6JN)	"G" MANAGER 4X2"
S130/150TI/170 (VF6JP)	
R370/390/420 →1989	

Sampa Nr.

**080.075**

O.E.M. Nr.

5010 133 895



Dimension

M6x1L

Description

Ball Joint, Left

AE380/385TI/420TI/500/520 PREMIUM  
"G" MANAGER KERAX  
G340TI TR 18T SISU

Sampa Nr.

**080.124**

O.E.M. Nr.

5010 239 842



Dimension

M6x1R

Description

Ball Joint, Right

AE380/385TI/420TI/500/520  
G340TI TR 18T  
PREMIUM TR 4X2 ==>1999  
PREMIUM 6X2&6X2/4 ==>1999  
AE MAGNUM390/420TI/430/470/560  
PREMIUM PR 4X2 ==> 1999  
KERAX ==> 1999  
KERAX FAB 33A==>S 2000==>2002

Sampa Nr.

**080.260**

O.E.M. Nr.

5010 294 307 C  
(4911 N P01)  
(4911 N P03)



Dimension

ø228x210

Description

Piston for Air Bellow

Sampa Nr.

**080.125**

O.E.M. Nr.

5010 211 555



Dimension

M6x1L

Description

Ball Joint, Left

AE380/385TI/420TI/500/520	AE MAGNUM390/420TI/430/470/560
M/S 150/180/210/220/230TI/250	PREMIUM PR 4X2 ==> 1999
"R" 1993-->	KERAX ==> 1999
G200/210/230TI	MIDLUM(FAB42B1/2-43C1/2-43T/M)
"G" MANAGER 4X2"	MAGNUM E-TECH 400/440/480
G340TI TR 18T	KERAX FAB 33A==>S 2000==>2002
PREMIUM TR 4X2 ==>1999	PREMIUM(FAB22EE/HA/HB/JJ/QQ/RR)
PREMIUM 6X2&6X2/4 ==>1999	MIDLUM(FAB 42US-44US-45US)

Sampa Nr.

**080.256**

O.E.M. Nr.

5010 152 854



Dimension

ø30xø45.5x45

Description

Bushing

TR/GR305	GRH/TRH350	GLR230 4X4 SINPAR
TR/GR350	GBH/TBH280 1981-->	770KB6 SP
GR/TR280	GLC/GLR190y230	
GRH/TRH305	GLM/TLM280	

Sampa Nr.

**080.544**

O.E.M. Nr.

-

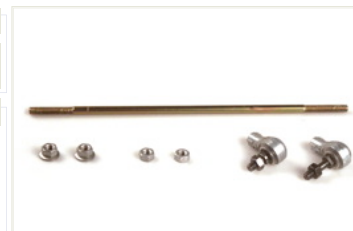

Dimension

M6x1

Description

Ball Joint Set

G340TI TR 18T  
PREMIUM TR 4X2 ==>1999  
PREMIUM 6X2&6X2/4 ==>1999

Sampa Nr.

**080.253**

O.E.M. Nr.

0000 490 601



Dimension

ø38xø152x51

Description

Dust Cover

GBH260/280 6X6  
GBH260/280 6X4 -->1980